

killerbody™

Wing Mirror W/LED Unit Set Fit for 1/7 RC Electric Car NO.48233

● Symbols used throughout the instruction manual, comprise:



Cut off shaded portion.



5mm
Drill holes with
the specified diameter.



Pay close attention here!



Must be purchased
separately.



Assemble left and right sides
the same way.

PARTS

Clip ----- X3

O-Ring ----- X3

SILVER MIRROR DECAL



PS PARTS

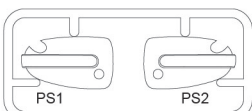

PLASTIC PARTS

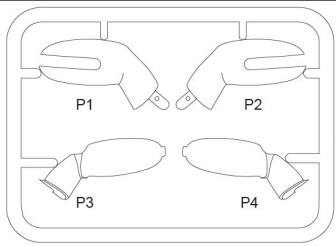

3MM LED LIGHT UNIT

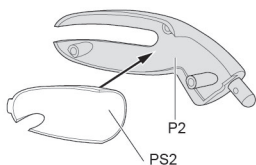
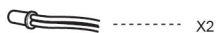

Step 1:
Stick the interior cover inside
the wing mirror.

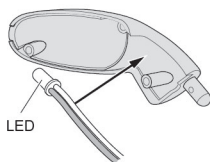

Step 2:
Put the 3mm LED light on the
mirror mount.

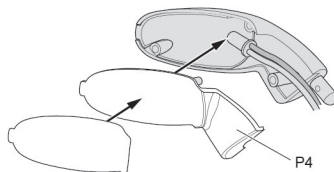

Step 3:
Put the mirror plate on the wing mirror,
then stick the silver mirror decal on the
mirror plate.

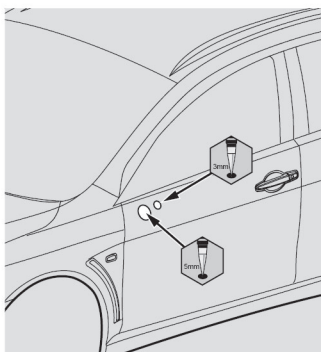

Step 4:
We recommend using our body
reamer to drill mounting holes.

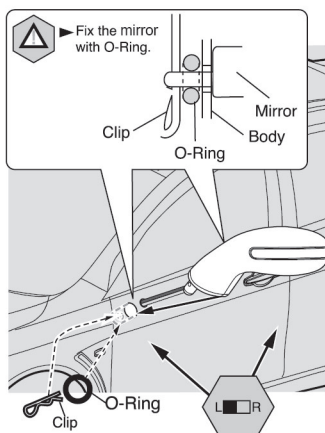

Step 5:
Insert the LED connecting wire and
fix the wing mirror with O-Ring on the
holes which we drilled in Step 4.



Assembled