



# 1/16 PRO Series OPERATING INSTRUCTIONS

Full proportion high-performance 4WD racing car



*This product is suitable for users over 14 years old.  
Please read this instruction manual carefully before use.*

## **Important Notice**

*Our company's products are improving all the time, design and specifications are subject to change without notice. All the information in this manual has been carefully checked to ensure accuracy, if any printing errors, our company reserve the final interpretation right.*



# THANK YOU

- Thank you for choosing this product. The remote control model is designed to be fun to drive and uses high quality parts to improve durability and performance. The instruction manual you are reading is to make the product easier to understand and explain more thoroughly. We hope you enjoy this remote control model car. If you have any problems or need help, please call us and we will try our best to help you. You can also contact us through the following website: [www.udirc.com](http://www.udirc.com).
- This is a high-performance radio control model product, which needs regular maintenance to obtain the best performance. If you don't do regular maintenance, it can affect performance. We have all the necessary parts and accessories to ensure that your vehicle maintains its best performance.
- The warning or attention symbol will alert you to potentially dangerous steps. Please read and understand the instructions carefully before proceeding.



**Failure to follow these instructions may result in injury to yourself or others. You may also cause property damage or model damage.**



## WARNING

- Before Operation**
- Read the instruction manual in detail, or ask for the person with experience in operation, and read with the guardian if necessary.
  - Make sure all screws and nuts are properly tightened.
  - The remote control and the vehicle should always use the battery with saturated power to avoid losing control of the model.
  - Please make sure that the throttle trigger is in the center position.
- During Operation**
- First turn on the power of the remote control, and then turn on the power of the model.
  - DO NOT operate in public streets or crowded places to avoid accidents.
  - Use this product only in open areas (>4x4m) without pedestrians.
  - DO NOT put fingers or any objects inside rotating and moving parts.
- After Operation**
- First turn off the model power, then turn off the remote control power. And take out the battery.
  - Daily maintenance is required after the model is used.

- Please read and observe all precautions before use. Improper use of battery may cause danger.
- It is normal for the battery to heat up after operation. Please be careful when handling the battery. If the wire is worn, it is easy to short circuit and cause fire.
- Wasted li-ion battery must not be placed with household trash. please contact local environmental or waste agency or the supplier of your model or your nearest li-ion battery recycling center.



## Battery safety

- 1) After use, please disconnect the power supply and pull out the plug;
- 2) Remove the battery from the model before charging;
- 3) DO NOT charge the battery when it is bulging or expanding;
- 4) Keep away from damp, corrosive environment and heat source;
- 5) Please charge the battery under adult supervision;
- 6) Pay attention to the polarity of the battery when installing or replacing the battery;
- 7) Different types of batteries or old and new batteries should not be mixed;
- 8) DO NOT short circuit any terminals;
- 9) DO NOT short circuit, decompose or put the battery into fire;
- 10) Please use the attached special charger to charge the battery.



- The product contains small and sharp parts. Keep away from children.
- Cutters, nippers and screwdrivers need careful handling.
- DO NOT put the model in high temperature, humidity and direct sunlight.
- The model must stop immediately and check for the reasons when it is operating abnormal.
- Keep in mind that people around you may also operate a radio control model.
- The motor is a heating part, please do not touch it.
- Please keep the package or instructions as they contain important information.

## Product maintenance

When not in use, remove the battery from the model and transmitter.



Please clean the sediment and dirt on the car before entering the warehouse.

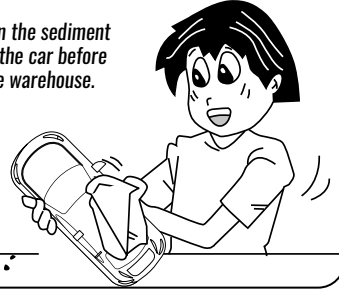

Apply lubricating oil to external metal parts.

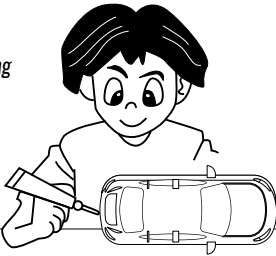

Please separate the car and battery when not in use.

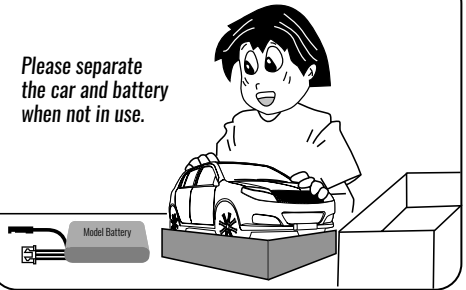

## Troubleshooting

Cause	Solution
Remote control car doesn't work	When the battery is low, charger it in time or replace it with new battery.
	Please make sure the wheel or drive shaft is entangled by debris and remove it.
	The motor may have reached the expiration date, replace with the same motor.
Long frequency matching time	The signal is disturbed, restart the car and the transmitter.
Operation delay	Please make sure there are obstacles or interferences.
The vehicle moves forward (backward) automatically or makes a sound of "en...."	Restart the transmitter

# 1 Guidance before operation

1>-1

## Battery charging

The battery contains less power when leaving the factory, so it must be charged and saturated before use.

Connect the attached charger with the model battery charging input port, and then connect other USB output ports. When charging, the charging indicator is flashing, and the indicator is always on after charging. Do not put the battery in the model when charging. The battery must be cooled before charging.

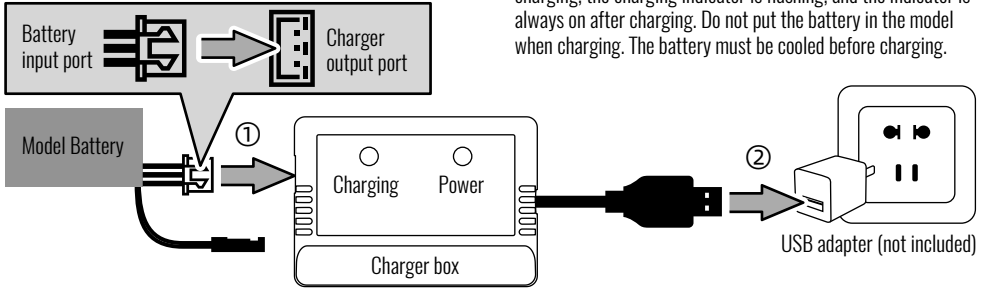

▲ Please use the charging box provided with the product and make sure it is connected properly.

**Warning: someone must be watching while charging.**

1>-2

## Assembly of model battery

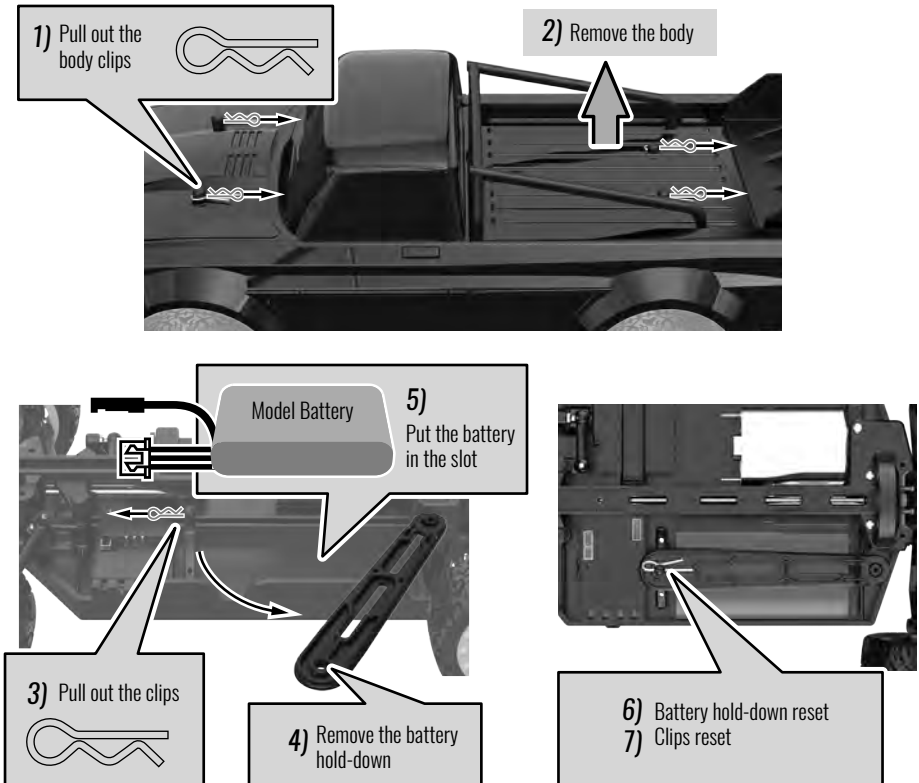

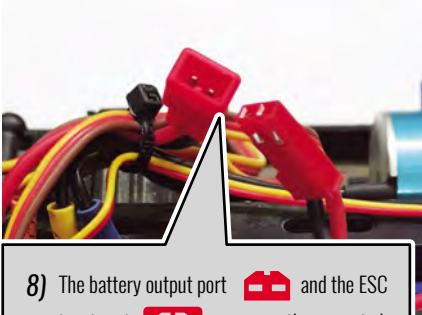

- 8) The battery output port  and the ESC input port  are correctly connected.

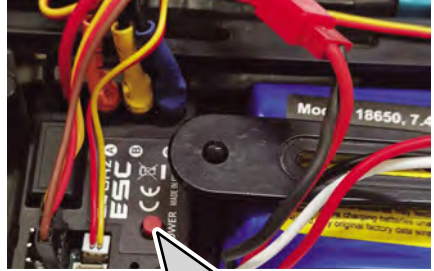

- 9)  Press for 1 second to turn on the power. The lights flash and enter the frequency matching state. Press for 2 second to turn off the power.



**After the battery is assembled, reset the body.**

## Preparation of transmitter

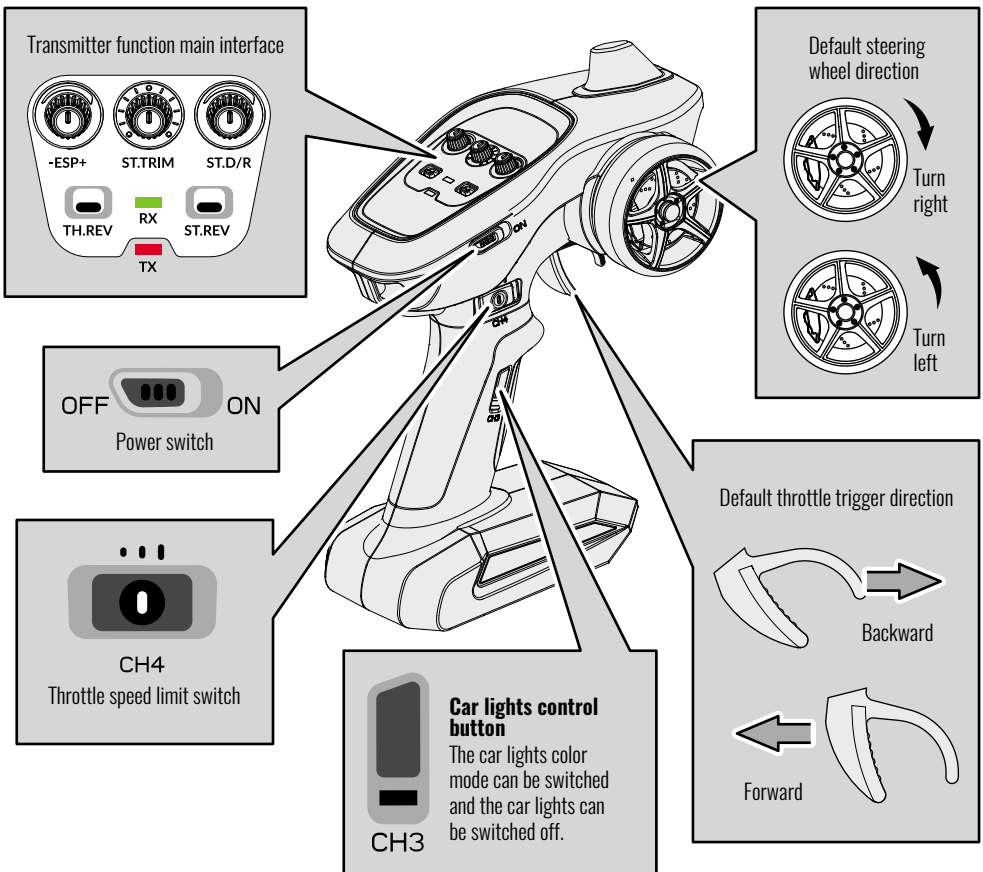

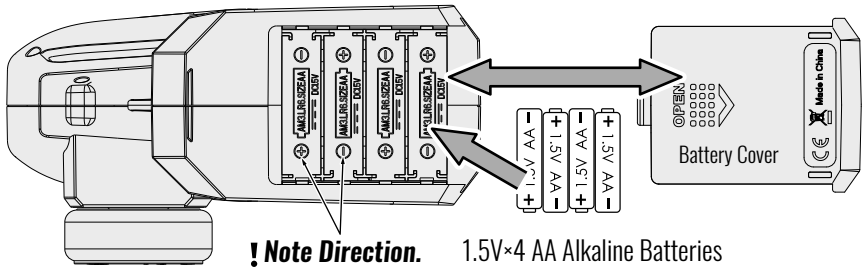

Open battery cover at the bottom of transmitter. Install batteries.  
Follow the direction of batteries designated in the inside of the battery box.

## 2 Operational guidance

### 1> Frequency matching

Place the model on level ground

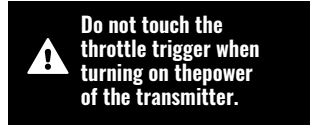
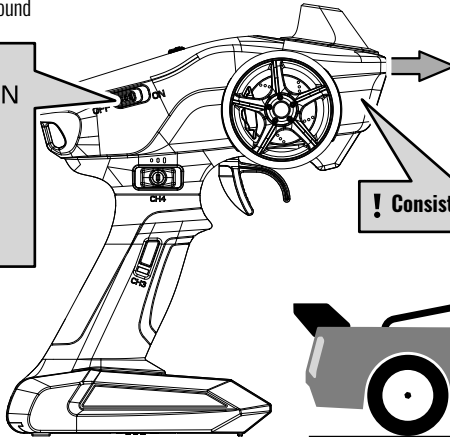
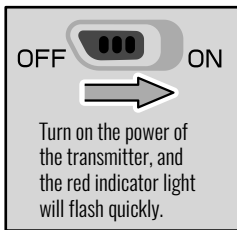

After the car power is turned on, the transmitter and the car will carry out automatic frequency matching. When the indicator light of the transmitter and the car lights are always on, the frequency matching is successful. In the process of frequency matching, the car lights will flash rapidly. At this time, the gyroscope is being calibrated automatically. Please place the car on the level ground to complete this operation. After calibration, the car lights return to normal.

### 2> Manipulation method

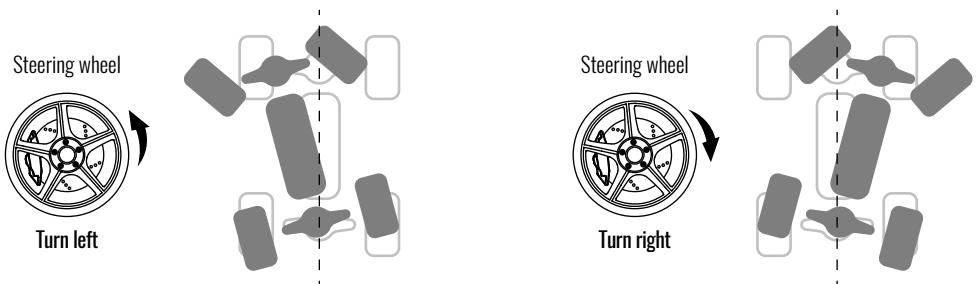

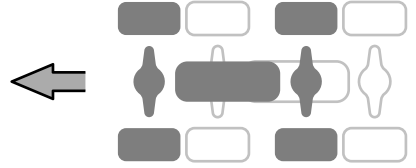
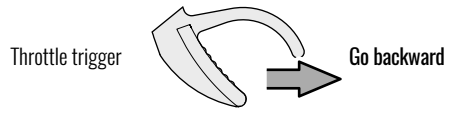
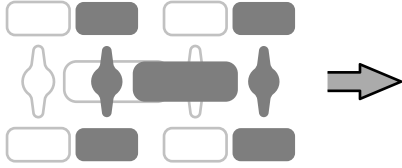
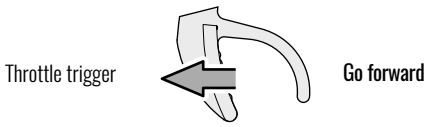

### Turn left and move forward

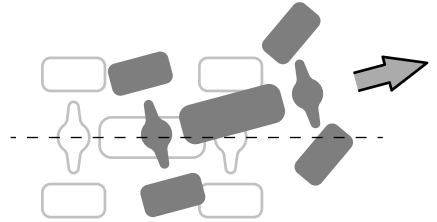
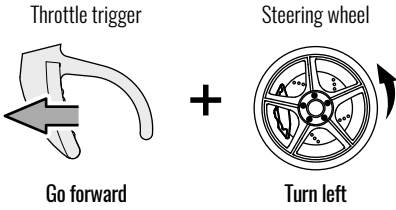

### Turn right and move forward

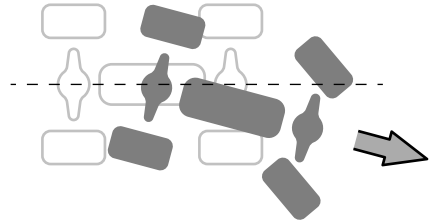
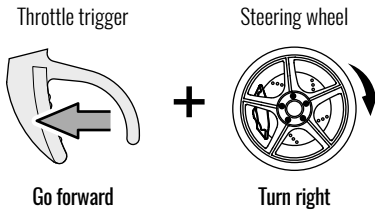

### Turn left and move backward

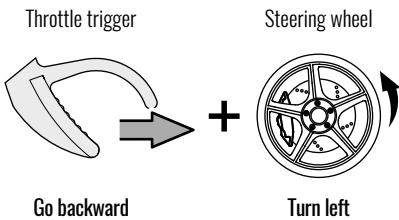

### Turn right and move backward

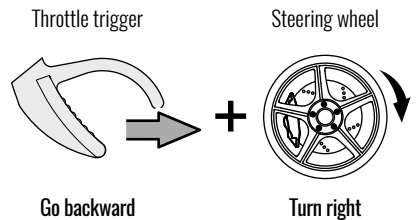



### Low speed

### High speed

### Brake/Backward

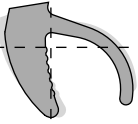

Pull the throttle trigger back gently and the car will move forward slowly.



The throttle trigger is pulled to the maximum, and the car moves forward quickly.

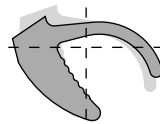

When the car is moving forward, the throttle trigger is pushed forward and the car stops moving. After the throttle trigger returns to the middle position, it pushes forward again, and the car moves backward.

3>

## Introduction of main interface function

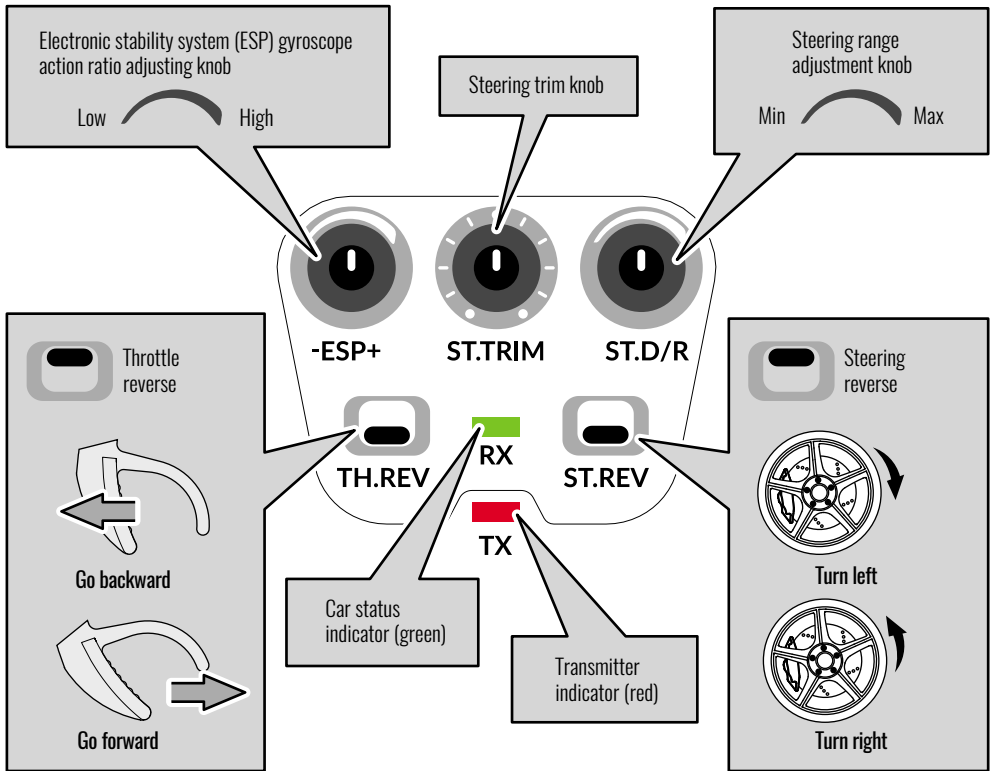

- 1) There is no ESP function when the remote control car retreats.
- 2) When the remote control car is moving forward, it is necessary to pull the throttle trigger backward to reach more than 30% of the stroke before the gyroscope starts to work.
- 3) With the increase of car speed, the gyroscope action ratio also increases synchronously.



**-ESP+**  
**Adjustment of gyroscope action ratio**

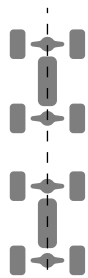



The action ratio decreased



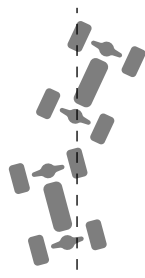

The action ratio increases

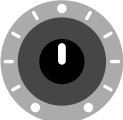

This product has the function of ESP car stability system, which can effectively correct the car attitude and direction when the car skids or loses control. The function and sensitivity of the car gyroscope sensor can be adjusted through the ESP knob of the transmitter.

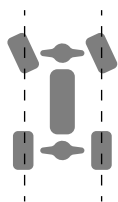

**ST.TRIM**  
**Steering trim**

When the front wheel is left, the knob rotates to the right.



When the front wheel is right, the knob rotates to the left.

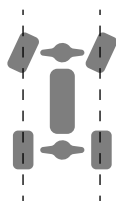

When the steering wheel is in the center position, if the car can not drive in a straight line, please use the steering trim knob to adjust and correct the left and right directions of the front wheels.



**ST.D/R**  
**Steering range adjustment**

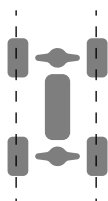

Minimum steering angle



Maximum steering angle

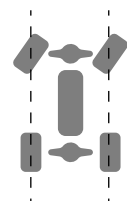



The steering range adjustment knob can be used to adjust the left and right steering angle of the car.

4>

## Model car speed control

By switching the three gears of the throttle speed limit switch, three different maximum speeds of the car can be set.

	Low speed mode: Throttle output limited to 50%.
	Medium speed mode: Throttle output limited to 75%.
	High speed mode: 100% throttle output.

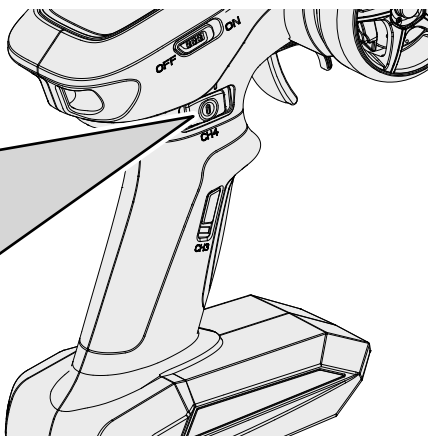

5>

## Weak signal alarm

When the signal is weak or the signal is interrupted, the red indicator of the transmitter will flash quickly. Please operate within the effective control distance to avoid accidents.

6>

## Low battery alarm

When the battery of the transmitter is low, the red indicator of the transmitter will flash slowly. When the car battery is low, the transmitter green indicator light flashes. The battery should be replaced as soon as possible to avoid accidents.

# 3 Replacement of parts

## 1> Replace the ESC

Pull out all the plugs and remove the ESC upward. Replace with a new ESC.

Use double-sided tape to attach the ESC to the chassis

**! Note Direction.**

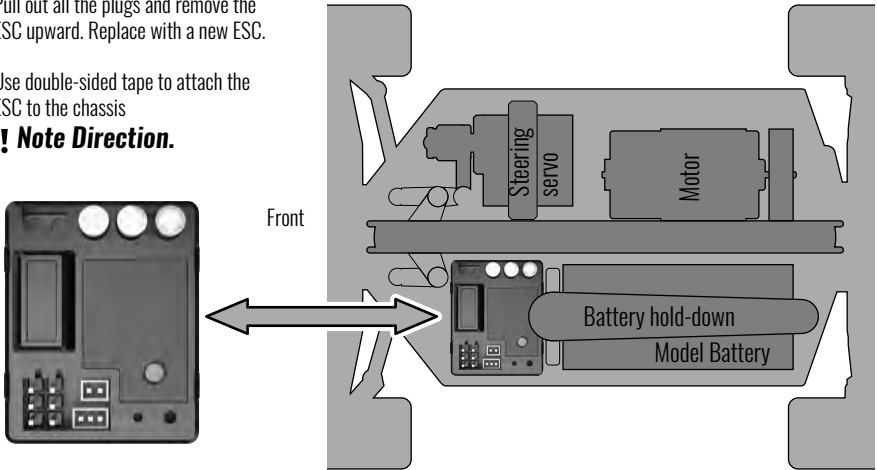

## Electronic equipment connection diagram

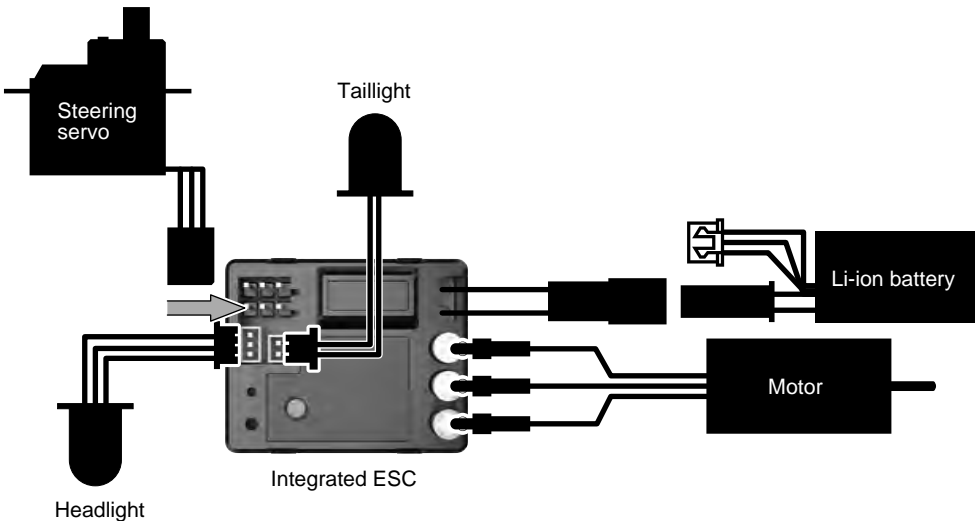

2>

# Replace the tires

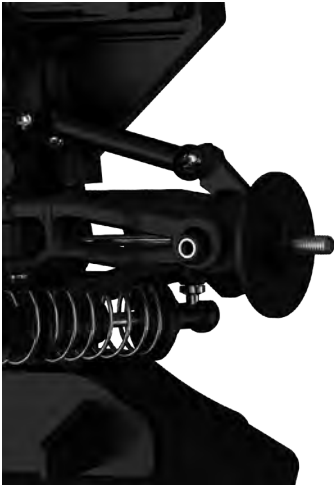

Use the hexagon nut wrench to take out the nut fixing the tire and remove the old tires. Put on new tires.



Hexagon nut wrench



3>

# Parts exploded view

## Left(Right) front wheel component

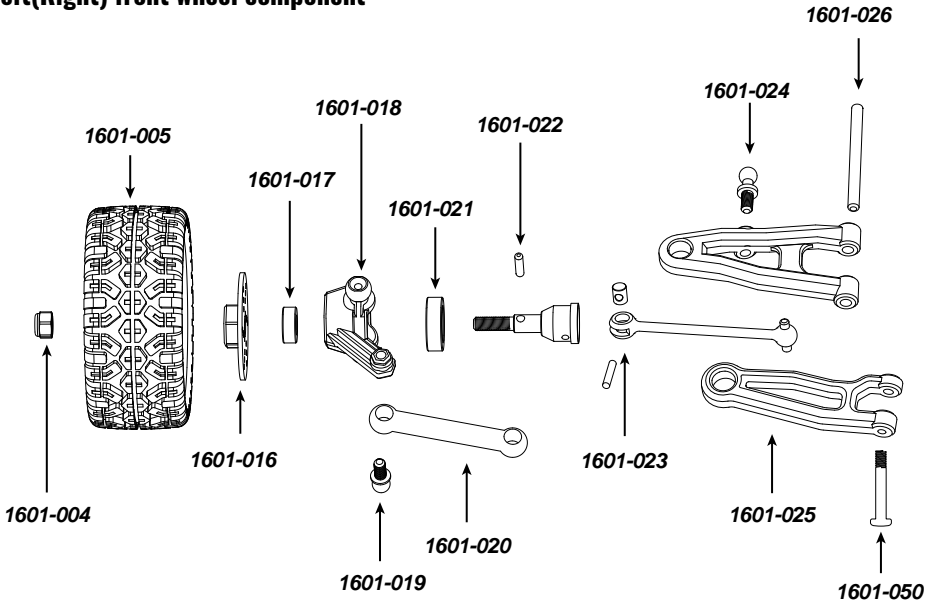



## Front (rear) shock absorber components

1601-009

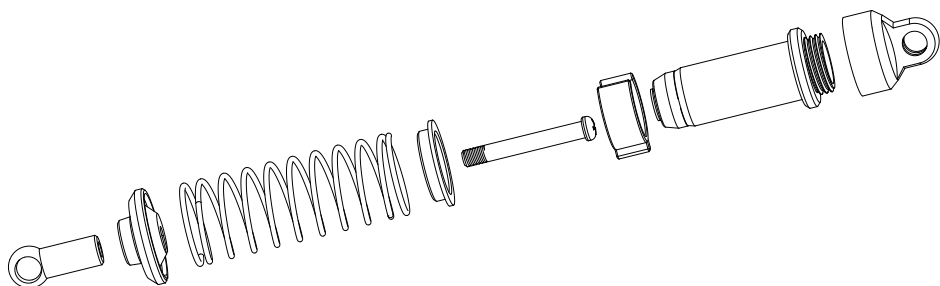

## Steering system components

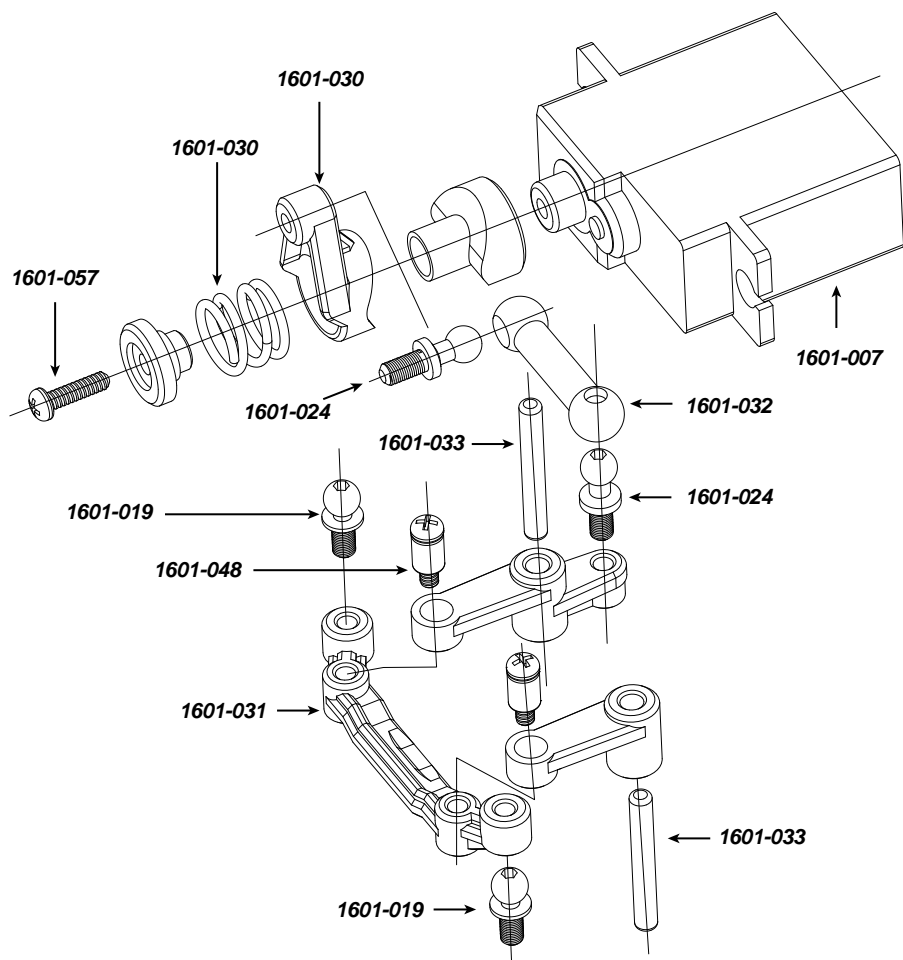



1601-002

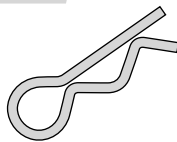

4

Body clips

1601-003



Headlight group

1601-004



3mm Locknut

1601-005 #B



4

Tire

MT2401



Brushless Motor

S1701



Steering servo

1601-009

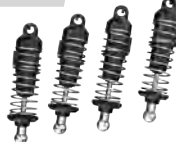

Front &amp; Rear shock assembly

1603-010



Front bumper assembly

ESC01W



2.4GHz Integrated ESC

1601-012



Li-ion Battery

1601-013



Battery hold-down

1601-015



Upper chassis

1601-016



4

Wheel adapters

1601-017



4

Ball bearing(8\*4\*3mm)

1601-018



Front &amp; Rear wheel carriers assembly

1601-019



4

2.5\*10mm Pivot balls

1601-020



2

Steering linkage

1601-021



4

Ball bearing(12\*8\*3.5mm)

1601-022



4

Shaft(1.8\*6.8mm)

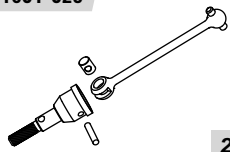

**1601-023****2**

Metal front CVD shafts

**1601-024****4**

2.5x12mm Pivot balls

**1601-025**

Suspension arms (front)

**1601-026****4**

Shaft(2.5x32mm)

**1601-027****2**Metal Rear Dogbones +  
Metal Rear Wheel shafts**1601-028**

Suspension arms (rear)

**1601-029**

Differential assembly

**1601-030**

Servo saver

**1601-031**

Steering bellcrank

**1601-032**

Rudder connecting rod

**1601-033****4**

Shaft(2.5x21mm)

**1601-034**

Differential housing

**1601-035**

Chassis

**1601-036**

Motor gear

**1601-037**

Motor mounts

**1601-038**

Main spur gear

**1601-039**

Bulkhead tie bars(front)

**1601-040**

Bulkhead tie bars(rear)

**1601-041**

Main propeller shaft

**1601-042**

Taillight group

**1601-043**

Charger

**1601-044**

Transmitter

**1601-045**

Cross screwdriver

**1601-046**

Socket nut wrench

**1601-048****8**2.5×11.8mm PM  
Shoulder screws**1601-049****8**

2.5×5mm PM Screws

**1601-050****8**2×13mm PM  
Screw pin set**1601-051****8**2.5×16.5mm PM  
Screw pin set**1601-047**

Hex wrench

**1601-052****8**

2.5×7mm KM Screws

**1601-053****8**

2.5×10mm KM Screws

**1601-054****8**

2.3×8mm PB Screws

**1601-055****8**

2×10mm PB Screws

**1601-056****8**

2.3×14mm PB Screws

**1601-057****8**

2.5×14mm PB Screws

**1601-058****8**

2.3×4×5mm PB Screws

**1601-059****8**

2.3×6×5mm PB Screws

**1601-060****8**

2.3×8×8mm PB Screws

**1601-061****8**

2.3×5×7mm PB Screws

**1601-062****8**

2.3×6mm PB Screws

# FCC Note

This equipment has been tested and found to comply with the limits for a Class B digital device, pursuant to Part 15 of the FCC Rules. These limits are designed to provide reasonable protection against harmful interference in a residential installation. This equipment generates uses and can radiate radio frequency energy and, if not installed and used in accordance with the instructions, may cause harmful interference to radio communications. However, there is no guarantee that interference will not occur in a particular installation. If this equipment does cause harmful interference to radio or television reception, which can be determined by turning the equipment off and on, the user is encouraged to try to correct the interference by one or more of the following measures:

- Reorient or relocate the receiving antenna.
- Increase the separation between the equipment and receiver.
- Connect the equipment into an outlet on a circuit different from that to which the receiver is connected.

**WARNING: Changes or modifications not expressly approved by the party responsible for compliance could void the user's authority to operate the equipment.**

## FCC Notice

The equipment may generate or use radio frequency energy. Changes or modifications to this equipment may cause harmful interference unless the modifications are expressly approved in the instruction manual. Modifications not authorized by the manufacturer may void user's authority to operate this device.

This device complies with Part 15 of the FCC Rules. Operation is subject to the following two conditions:

- (1) This device may not cause harmful interference.
- (2) This device must accept any interference received, including interference that may cause undesired operation.

## FCC Radiation Exposure Statement

The device has been evaluated to meet general RF exposure requirement.  
The device can be used in portable exposure condition with out restriction.

# ! WARNING

Warning: The product should only be used by adults and children over 14 years.

Adult supervision is required for children under 14 years.

Hinweis: Dieses Produkt ist für die Erwachsene und die Kinder ab 14 Jahren.

Die Kinder unter 14 Jahren müssen von Erwachsenen beaufsichtigt werden.

Avertissement: Ce produit est destiné aux adultes et aux enfants de plus de 14 ans.

Les enfants de moins de 14 ans doivent être surveillés par des adultes.

Avvertimento: Questo prodotto è destinato all'uso per i adulti e bambini di età superiore ai 14 anni.

I bambini di età inferiore ai 14 anni devono essere sorvegliati da un adulto.

Advertencia: Este producto es para adultos y niños mayores de 14 años.

Los niños menores de 14 años deben ser supervisados por adultos.

警告: この製品は、大人と14歳以上の子供には使用対象です。

14歳未満の子供は大人の監視が必要です。



**DANGER!**

**Only suitable  
for age 14+**



Demo video



Operation guide  
download



**Manufacturer: UDIRC TECHNOLOGY CO., LTD**

Address: Guangfeng Industrial Zone, Guangyi Street, Chenghai District, Shantou City, Guangdong Province, CN