

Revell®

KIT 0386

85038600200

CARIBBEAN PIRATE SHIP

"The Galleon appeared out of the mist on the early morning horizon, off the port quarter, bearing down on us from out of the blood-red sunrise. At first we took her for a merchant ship. Like us, traveling home from the Jamaica coast or the Bahamas heavily laden with cargo...But she was moving too fast. As she approached, she dropped her main sail and revealed her dreaded skull and crossbones. Pirates! We now knew of her sinister intentions. We went hard to starboard to try and catch a beam reach, praying she would not overtake us..."

Like an exciting high-seas novel comes the Caribbean Pirate ship kit from Revell. Features include 6 on deck cannon and molded ratlines. Authentic galleon details and colorful pirate decals will make this a ship that will stand out anywhere.



* REPEAT SEVERAL TIMES
* A REPETER PLUSIEURS FOIS



* OPTIONAL PARTS
* PIECES EN OPTION



* DECAL
* DECAL COMANIE



* ALTERNATIVE ASSEMBLY
* ENSEMBLAGE ALTERNATIVE



* CEMENT TOGETHER
* A COLLER



* REMOVE AND THROW AWAY
* A RETIRER ET JETER



* DO NOT CEMENT
* NE PAS COLLER

READ THIS BEFORE YOU BEGIN

- * Study the assembly drawings.
- * Each plastic part is identified by a number.
- * In the assembly drawings, some parts will be marked by a star (★) to indicate chrome plated plastic.
- * For better paint and decal adhesion, wash the plastic parts in a mild detergent solution. Rinse and let air dry.
- * Check the fit of each piece before cementing in place.
- * Use only cement for polystyrene plastic.
- * Scrape plating and paint from areas to be cemented.
- * Allow paint to dry thoroughly before handling parts.
- * Any unused parts may be discarded.

DECAL APPLICATION INSTRUCTIONS

1. Cut desired decal from sheet.
2. Dip decal in water for a few seconds.
3. Place wet decal on paper towel.
4. Wait until decal is movable on paper backing.
5. Place decal in position on model, face up and slide backing away.
6. Press out air bubbles with a soft damp cloth.
7. Milkiness that may appear is for better decal adhesion and will dry clear. Wipe away any excess adhesive.
8. Do not touch decal until fully dry.
9. Allow the decals 48 hours to dry before applying clear coat.

NOTE: Decals are compatible with setting solutions or solvents.

LIRE CE QUI SUIT AVANT DE COMMENCER

- * Etudier les schémas de montage.
- * Chaque pièce en plastique est identifiée par un numéro.
- * Sur les schémas de montage, certaines pièces sont marquées d'une étoile (★) pour indiquer qu'elles sont en plastique chromé.
- * Pour une meilleure prise de la peinture et des autocollants, laver les pièces en plastique avec une solution détergente peu concentrée. Les rincer et les laisser sécher à l'air.
- * Vérifier que chaque pièce s'ajuste bien avant de la coller en place.
- * N'utiliser que de la colle pour polystyrène.
- * Gratter les parties à coller pour enlever le chrome et la peinture.
- * Laisser la peinture bien sécher avant de manipuler les pièces.
- * Toute pièce inutilisée peut être jetée.

DIRECTIVES D'APPLICATION DES AUTOCOLLANTS

1. Découper l'autocollant désiré de la feuille.
2. Tremper l'autocollant dans de l'eau pendant quelques secondes.
3. Placer l'autocollant mouillé sur une serviette en papier.
4. Attendez que l'autocollant puisse être déplacé sur son support en papier.
5. Mettre l'autocollant en position sur le modèle face sur le dessus et faire glisser le support pour l'enlever.
6. Appuyer avec un chiffon doux humide pour éliminer les bulles d'air.
7. La substance laiteuse qui peut apparaître est destinée à améliorer l'adhésion de l'autocollant et devient incolore au séchage. Essuyer pour enlever tout excédent d'adhésif.
8. Ne pas toucher l'autocollant tant qu'il n'est pas bien sec.
9. Laisser l'autocollant sécher pendant 48 heures avant d'appliquer une couche transparente.

REMARQUE: Les autocollants sont compatibles avec les solutions de fixation ou les solvants.

This paint guide is provided to complete this kit as shown on the box.

Ce guide de peintures est fourni pour reproduire le modèle réduit qui apparaît sur la boîte.

Flat Black

Noir mat

Flat Red

Rouge mat

Flat Tan

Havane mat

Flat White

Blanc mat

Gold Metallic

Or métallisé

Ivory

Ivoire

Turn Signal Amber

Ambre

Dark Green

Vert Foncé

If you have any questions or comments, call our hotline at: **(800) 833-3570**
or, please write to:

Revell-Monogram Consumer Service Department, 725 Landwehr Road, Northbrook, Illinois 60062

Be sure to include the plan number (85038600200), part number, description, your return address and phone number.

Visit our website: www.revell.com

1

DECK AND DETAILS ASSEMBLY

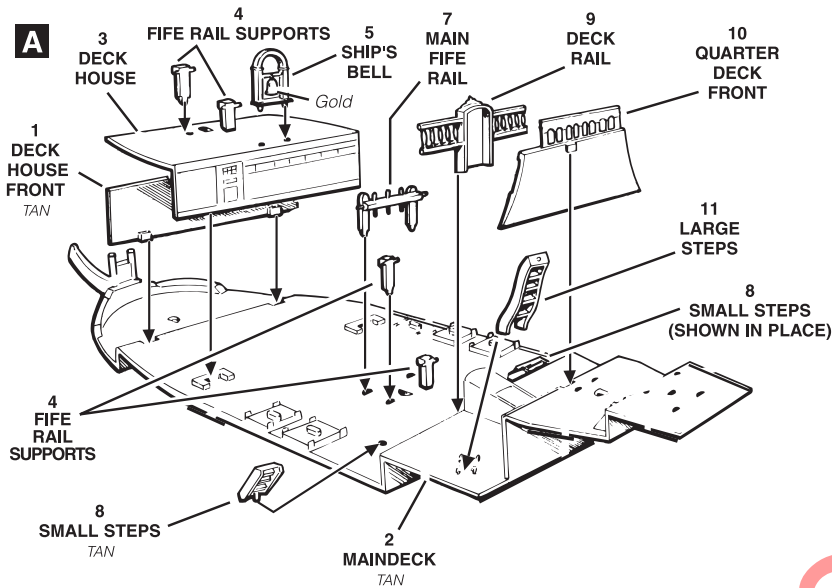

1. Cement the DECK HOUSE FRONT Part (1) and DECK HOUSE (3) to the MAIN DECK (2).
2. Cement two FIFE RAIL SUPPORTS (4) and the SHIP'S BELL (5) to the DECK HOUSE ROOF.
3. Cement the MAIN FIFE RAIL (7) and two Parts (4) to the MAIN DECK.
4. Cement two STEPS (8) and RAIL (9) to MAIN DECK.
5. Cement the QUARTER DECK FRONT (10) and STEPS (11) to the DECK.

B

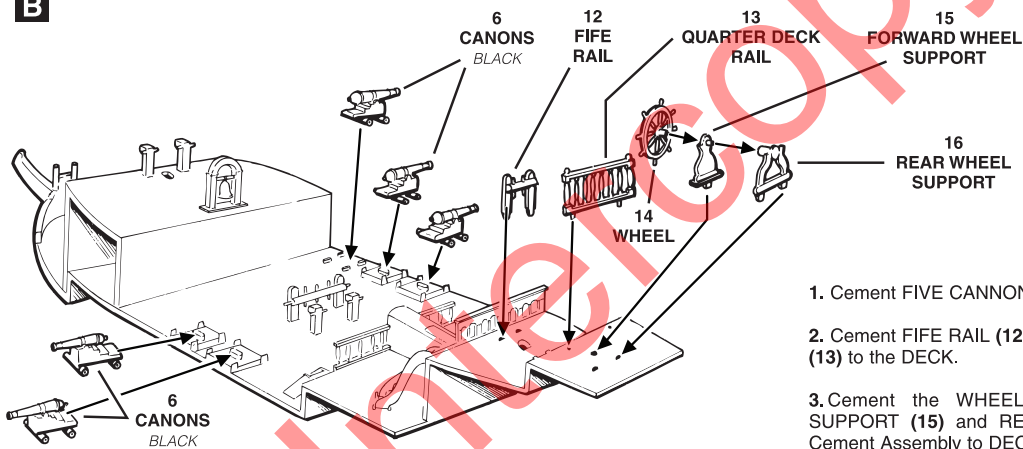

1. Cement FIVE CANNONS Part (6) to MAIN DECK.
2. Cement FIFE RAIL (12) and QUARTER DECK RAIL (13) to the DECK.
3. Cement the WHEEL (14), FORWARD WHEEL SUPPORT (15) and REAR SUPPORT (16) together. Cement Assembly to DECK.

2

HULL ASSEMBLY

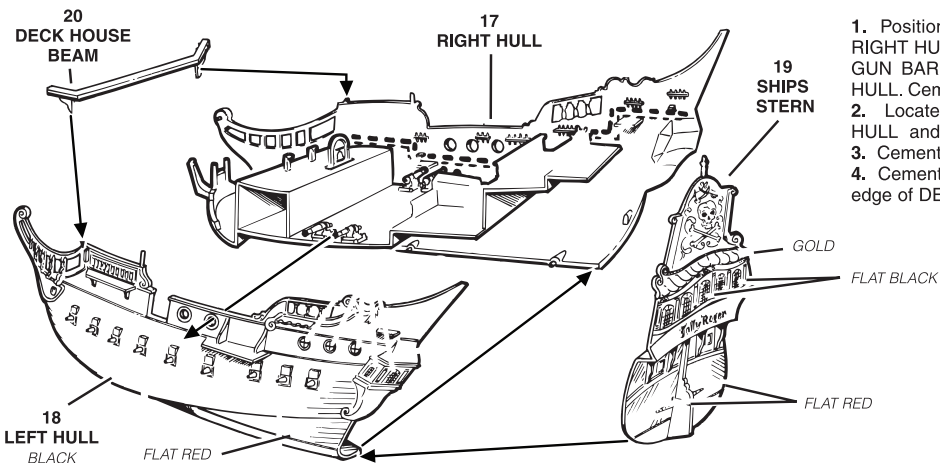

1. Position Deck Assembly on Tab locators in RIGHT HULL (17). GUN BARRELS will stick through GUN PORTS in HULL. Cement DECK to HULL.
2. Locate LEFT HULL (18) to DECK and RIGHT HULL and cement in place.
3. Cement SHIP'S STERN (19) to HULL.
4. Cement the DECK HOUSE BEAM (20) at forward edge of DECK HOUSE ROOF.

3

MAST ASSEMBLY

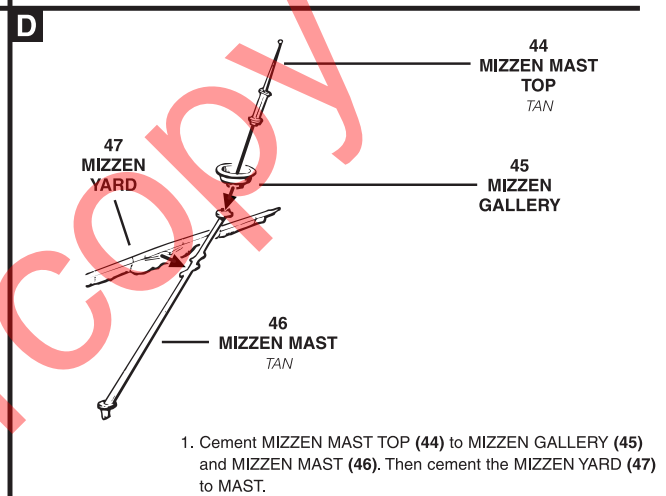
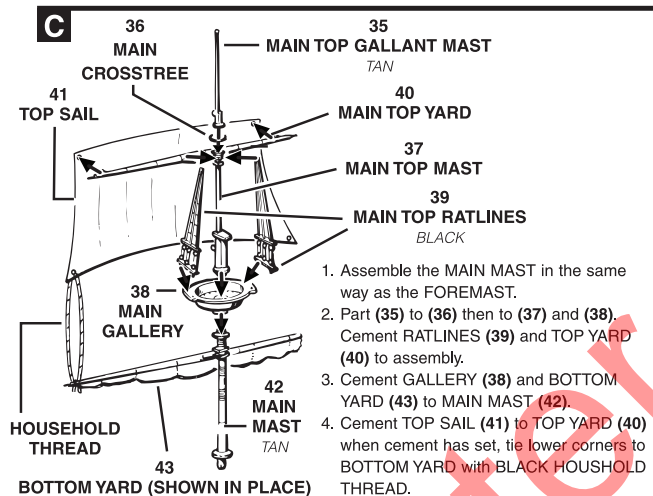
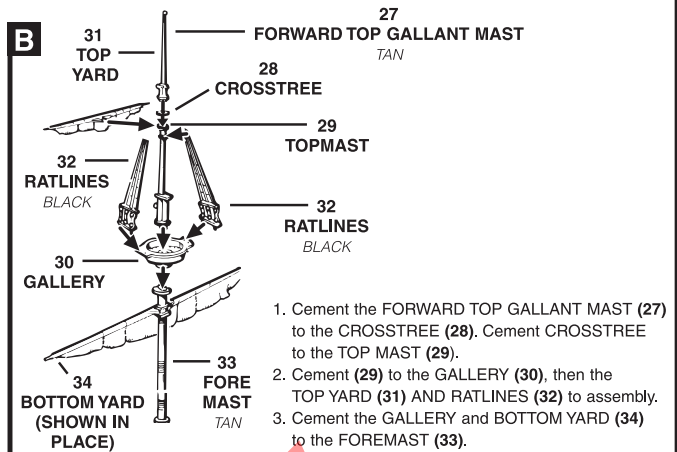
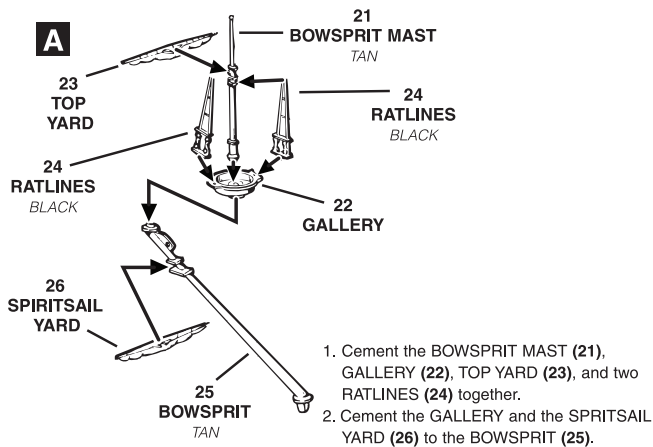

4

MASTS AND DETAILS ASSEMBLY

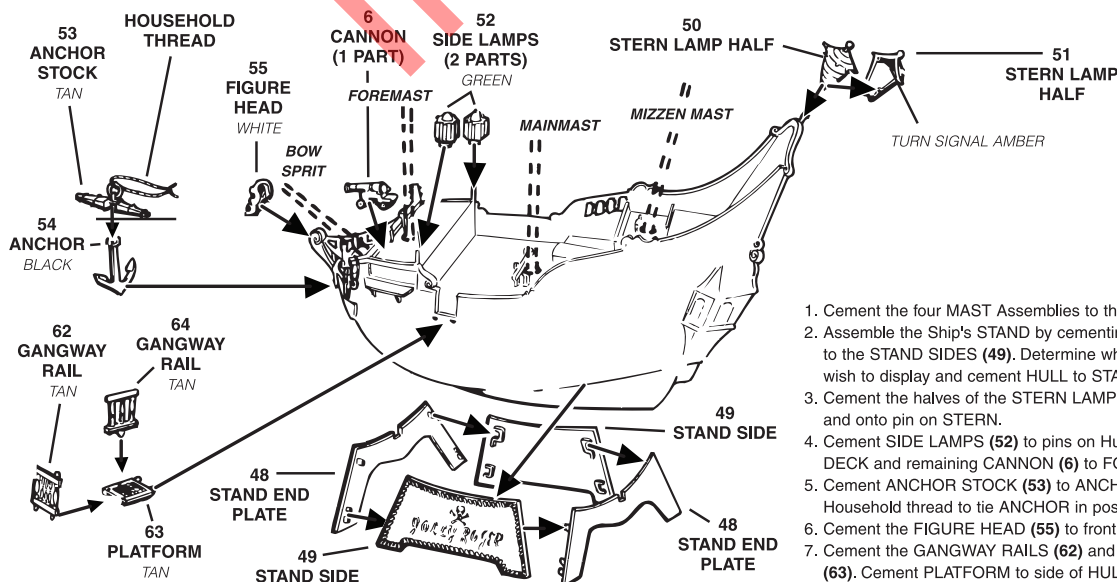

1. Cement the four MAST Assemblies to the DECKS as shown.
2. Assemble the Ship's STAND by cementing two END PLATES (48) to the STAND SIDES (49). Determine which side of your model you wish to display and cement HULL to STAND.
3. Cement the halves of the STERN LAMP (50) and (51) together and onto pin on STERN.
4. Cement SIDE LAMPS (52) to pins on Hull sides at top of FORE DECK and remaining CANNON (6) to FORE DECK.
5. Cement ANCHOR STOCK (53) to ANCHOR (54). Use Black Household thread to tie ANCHOR in position as shown.
6. Cement the FIGURE HEAD (55) to front of HULL.
7. Cement the GANGWAY RAILS (62) and (64) to the PLATFORM (63). Cement PLATFORM to side of HULL.

5

USE HOUSEHOLD
THREAD FOR RIGGING
(NOT INCLUDED)

RIGGING ASSEMBLY

A

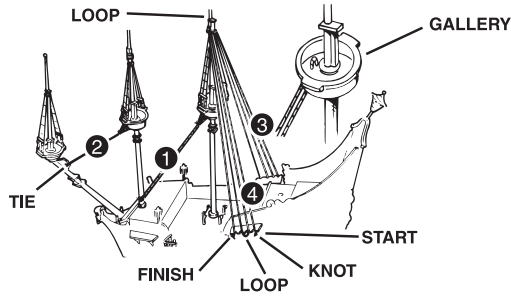

Install LINE ONE by placing the end of a length of THREAD through each hole in the GALLERY. Wrap end around base of MAST and tie. Install LINE TWO the same way, but tie to hole in BOWSPRIT.
Line 3 BACK STAYS. Knot thread and cement in notch in Hull side plate. Lead thread up around mast and down to notch on other side of Hull, Cement each notch as used to retain thread.

B

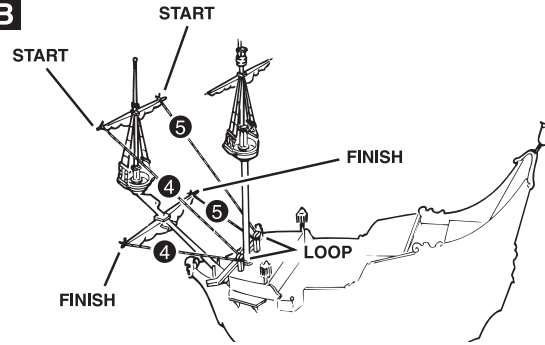

Install FOREMAST lines four and five. Loop thread under FIVE RAIL PINS and cement to hold in position

C

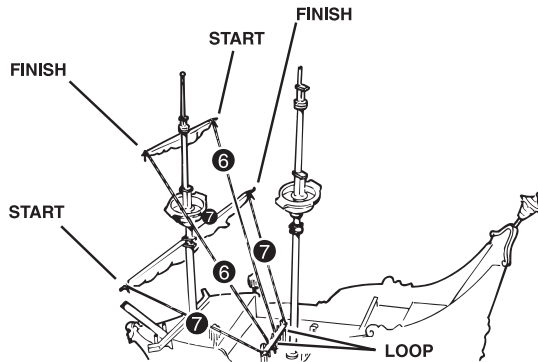

Install FOREMAST lines six and seven, Loop thread under FIVE RAIL PINS and cement to hold in position.

D

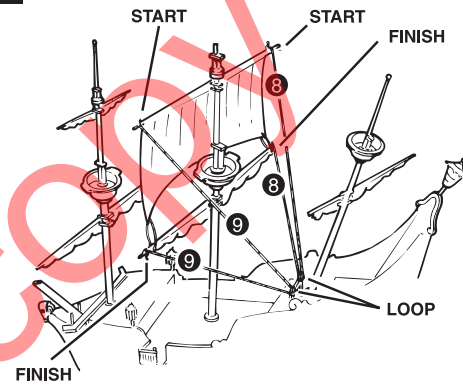

Install MAINMAST Lines eight and nine.

6

FINAL ASSEMBLY

1. Cement FOREMAST LOWER RATLINES (56) and (57) in position.

2. Cement MAINMAST RATLINES (58) and (59) in position.

3. Cement MIZZEN MAST RATLINES (60) and (61) to assembly.

4. Cutout FLAGS and wrap around MASTS. Cement together with white glue.

5. Install MAST TOP Thread as shown.

