



07821-0379

easy-click system



DEUTZ D30

Beiliegenden Sicherheitstext beachten / Please note the enclosed safety advice

- Ⓢ Beiliegenden Sicherheitstext beachten und nachschlagbereit halten.
- Ⓢ Please note the enclosed safety advice and keep safe for later reference.
- Ⓢ Respecter les consignes de sécurité ci-jointes et les conserver à portée de main.
- Ⓢ Houdt u aan de bijgaande veiligheidsinstructies en hou deze steeds bij de hand.
- Ⓢ Seguire le avvertenze di sicurezza allegate e tenerle a portata di mano.
- Ⓢ Observar y siempre tener a disposición este texto de seguridad adjunto.
- Ⓢ Ter em atenção o texto de segurança anexo e guardá-lo para consulta.
- Ⓢ Overhold vedlagte sikkerhedsanvisninger og hav dem liggende i nærheden.
- Ⓢ Ha alltid vedlagt sikkerhetstekst klar til bruk.
- Ⓢ Beakta bifogad säkerhetstext och håll den i beredskap.
- Ⓢ Huomioi ja säilytä oheiset varoitukset.
- Ⓢ Соблюдать технику безопасности, сохранить инструкцию для дальнейших обращений.
- Ⓢ Przestrzegać załączonego tekstu dotyczącego bezpieczeństwa i mieć go zawsze pod ręką.
- Ⓢ Dodržujte tento příložený bezpečnostní text a mějte ho po ruce.
- Ⓢ A mellékelt biztonsági szöveget vegye figyelembe és tartsa fellelőzörsra készen.
- Ⓢ Respektujte příložený bezpečnostní text a uchovajte ho pre budúce použitie.
- Ⓢ Respectați textul de siguranță atașat și păstrați-l la îndemână.
- Ⓢ Спазвайте приложениа текст за безопасност и го дръжте под ръка за справки.
- Ⓢ Priložena varnostna navodila izvajajte in jih hranite na vsem dostopnem mestu.
- Ⓢ Αδβετε υπόψη σας το συννημένο κείμενο ασφαλείας και φυλάξτε το ώστε να ανατρέχετε σε αυτό όποτε χρειάζεται.
- Ⓢ Ekteki güvenliik talimatlarını dikkate alıp, bakabileceginiz bir sekilde muafaza ediniz.

© 2019 Revell GmbH, Henschelstr. 20-30, D-32257 Bünde.

REVELL IS THE REGISTERED TRADEMARK OF REVELL GMBH, GERMANY. www.revell.de

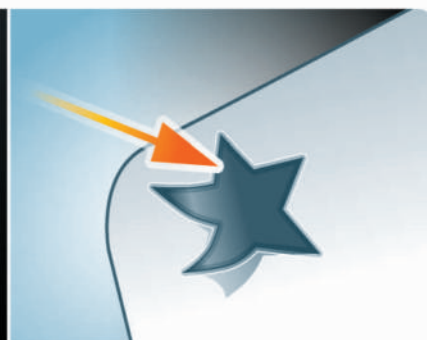
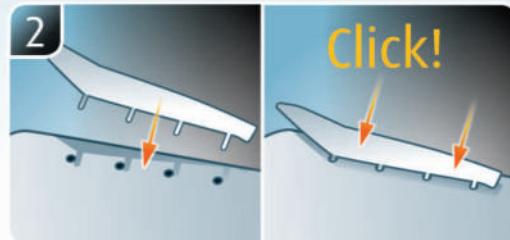
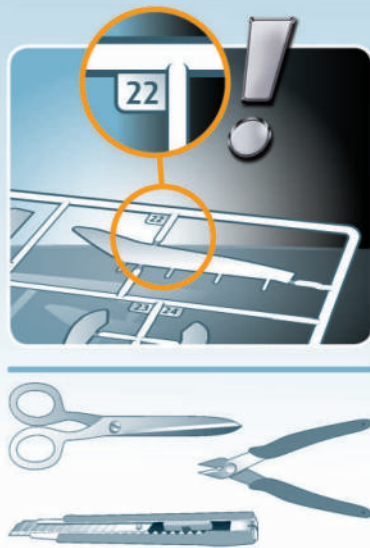

OPTIONAL · OPTIONAL · EN OPTION
 OPTIONEEL · OPCIONAL · OPTIONAL *

Painting

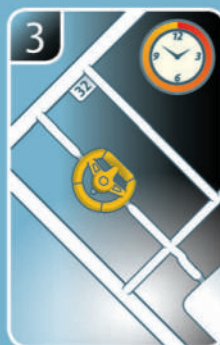

Decals



☞ Weitere Tipps und Tricks.
 ☞ Additional tips and tricks.
 ☞ Conseils et astuces supplémentaires.
 ☞ Andere tips en trucs.
 ☞ Ulteriori consigli e suggerimenti.
 ☞ Consejos y sugerencias adicionales.
 ☞ Mais dicas e truques.
 ☞ Flere tips og tricks.
 ☞ Flere tips og tricks.
 ☞ Ytterligere tips och tricks.
 ☞ Lisää vinkkejä ja nikkejä.
 ☞ Другие советы и хитрости.

☞ Dalsze wskazówki i sugestie.
 ☞ Další tipy a rady.
 ☞ További ötletek és fogások.
 ☞ Dalsie tipy a triky.
 ☞ Alte sfaturi și trucuri.
 ☞ Други полезни съвети и трикове.
 ☞ Nadaljnji nasveti in zvižaje.
 ☞ Πρόσθετες συμβουλές και κόλπα.
 ☞ Diğər önerilər və ipuçları.

www.revell.de

* ☞ Opcional
 ☞ Valgfritt
 ☞ Valgfritt
 ☞ Övrigt
 ☞ Valinnainen
 ☞ Дополнительно
 ☞ Opcja
 ☞ Voliteľný krok

☞ Opcióként
 ☞ Voliteľné
 ☞ Opțional
 ☞ Опция
 ☞ Dodatno
 ☞ Προαιρετικά
 ☞ Opsiyonel



- ☒ Bemalen
- ☒ Paint
- ☒ Peindre
- ☒ Beschilderen
- ☒ Colorare
- ☒ Pintar
- ☒ Pintar
- ☒ Mal
- ☒ Male
- ☒ Måla
- ☒ Maalaa
- ☒ Раскрасить
- ☒ Pomalować
- ☒ Pomalovat
- ☒ Fesse be
- ☒ Natrîef
- ☒ Vopsîti
- ☒ Боядисајте
- ☒ Robarvajte
- ☒ Βάψτε
- ☒ Boyama



- ☒ Zusammenbau Reihenfolge.
- ☒ Sequence of assembly.
- ☒ Ordre d'assemblage.
- ☒ Volgorde van montage.
- ☒ Sequenza di assemblaggio.
- ☒ Secuencia de montaje.
- ☒ Sequência de montagem.
- ☒ Samlerækkefølge.
- ☒ Monteringsrekkefølge.
- ☒ Montering ordningsføljd.
- ☒ Kokoamisjärjestys.
- ☒ Последовательность сборки.
- ☒ Kolejność montażu.
- ☒ Pořadí složení.
- ☒ Összerakási sorrend.
- ☒ Poradie zostavenia.
- ☒ Ordinea asamblării.
- ☒ Последовательность на сглобяване.
- ☒ Vrstni red sestavljanja.
- ☒ Σειρά τοποθέτησης.
- ☒ Parçaları birleştirme sırası.



- ☒ Anzahl der Arbeitsgänge.
- ☒ Number of working steps.
- ☒ Nombre d'étapes de travail.
- ☒ Het aantal bouwstappen.
- ☒ Numero di fasi di lavoro.
- ☒ Número de pasos de trabajo.
- ☒ Número de passos de trabalho.
- ☒ Número de etapas de trabalho.
- ☒ Antal arbejdsopgaver.
- ☒ Antal arbejdsstrinn.
- ☒ Antal operationer.
- ☒ Työvaiheiden määrä.
- ☒ Количесво операций.
- ☒ Liczba cykli roboczych.
- ☒ Počet pracovných krokov.
- ☒ A munkamenetek száma.
- ☒ Počet pracovných operácií.
- ☒ Numărul etapelor de lucru.
- ☒ Број работни стъпки.
- ☒ Število delovnih postopkov.
- ☒ Αριθμός βημάτων εργασίας.
- ☒ Çalışma adımı sayısı.



- ☒ Abziehbild in Wasser einweichen und anbringen.
- ☒ Soak and apply decals.
- ☒ Mouiller et appliquer les décalcomanies.
- ☒ Transfer in water even laten weken en aanbrengen.
- ☒ Immergere la decalcomania nell'acqua e applicarla.
- ☒ Mojar y aplicar calcomanías.
- ☒ Amolecer o decalque em água e aplicar.
- ☒ Gør overføringsbilledet vådt og sæt det på.
- ☒ Myk opp avtrekkingsbildet i vann og sett på.
- ☒ Blötlägg dekalen i vatten och sätt på den.
- ☒ Pehmitä siirtokuvaa vedessä ja siirrä paikalleen.
- ☒ Опустите переводную картинку в воду и нанесите её.
- ☒ Namoczyc kalkomanie w wodzie i przykleic.
- ☒ Nechte obtisk odmočit ve vode a přilepte.
- ☒ Merítse vízbe és helyezze fel a matricát.
- ☒ Obľáčkový obrázok namočte do vody a priložte na plochu.
- ☒ Înmuiați abțibildul în apă și aplicați-l.
- ☒ Потопете ваденката във вода и я поставете.
- ☒ Prelepnicu namakajte v vodi. In namestite.
- ☒ Μουσκεψτε σε νερό και τοποθετήστε τις χαλκομανίες.
- ☒ Çikartmayı suda yumuşatın ve takın.



- ☒ Wahlweise
- ☒ Optional
- ☒ Facultatif
- ☒ Naar keuze
- ☒ Facultativamente
- ☒ Opcional
- ☒ Opcional
- ☒ Valgfri
- ☒ Valgfritt
- ☒ Valfri
- ☒ Valinnaisesti
- ☒ На выбор
- ☒ Opcjonalnie
- ☒ Voliteľné
- ☒ Választás szerint
- ☒ Alternativne
- ☒ Opțional
- ☒ По избор
- ☒ Izbirno
- ☒ Προαιρετικά
- ☒ Opsiyonel



- ☒ Entfernen
- ☒ Remove
- ☒ Détacher
- ☒ Verwijderen
- ☒ Rimuovere
- ☒ Eliminar
- ☒ Remover
- ☒ Fjern
- ☒ Fjerne
- ☒ Ta bort
- ☒ Poista
- ☒ Удалить
- ☒ Usunąć
- ☒ Odstranit
- ☒ Eltávolítani
- ☒ Odstráňte
- ☒ Independenți
- ☒ Отстранете
- ☒ Odstranitev
- ☒ Διαβάστε
- ☒ Çıkar



- ☒ Bauanleitung sorgfältig lesen.
- ☒ Read the assembly instructions carefully.
- ☒ Lisez attentivement les instructions de montage.
- ☒ Bouwinstructies zorgvuldig doorlezen.
- ☒ Leggere attentamente le istruzioni per il montaggio.
- ☒ Lea cuidadosamente las instrucciones de montaje.
- ☒ Ler atentamente as instruções de montagem.
- ☒ Læs byggevejledningen omhyggeligt.
- ☒ Les byggeanvisningen nøye.
- ☒ Monteringsinstruktionerna skall läsas noggrant.
- ☒ Lue kokoamisohje huolellisesti.
- ☒ Внимательно прочитайте инструкцию по сборке.
- ☒ Dokładnie przeczytać instrukcję montażu.
- ☒ Prečtete si pečlivě návod k obsluze.
- ☒ Figyelmesen olvassa el a szerelési útmutatót.
- ☒ Návod na montáž starostlivo prečítajte.
- ☒ Citiji cu atenție instrucțiunile de montare.
- ☒ Прочетете внимателно уљвнато за монтаж.
- ☒ Skrbno preberite navodila za sestavo.
- ☒ Διαβάστε προσεκτικά τις οδηγίες κατασκευής.
- ☒ Yarı kilavuzunu dikkatle okuyun.



- ☒ Klarsichtteile
- ☒ Clear parts
- ☒ Pièces transparentes
- ☒ Transparente onderdelen
- ☒ Parti trasparenti
- ☒ Piezas transparentes
- ☒ Peças transparentes
- ☒ Klare dele
- ☒ Klare deler
- ☒ Genomskinliga detaljer
- ☒ Läpinäkyvät osat
- ☒ Прозрачные детали
- ☒ Przezroczyste części
- ☒ Průhledné diely
- ☒ Átlátszó alkatrészek
- ☒ Číre diely
- ☒ Piese transparente
- ☒ Прозрачни части
- ☒ Prozorni deli
- ☒ Διαφανή μέρη
- ☒ Şeffaf parçalar



- ☒ Chromteile
- ☒ Chrome parts
- ☒ Pièces chromées
- ☒ Chrom onderdelen
- ☒ Parti cromate
- ☒ Piezas cromadas
- ☒ Peças de cromo
- ☒ Forkromede dele
- ☒ Kromdeler
- ☒ Kromdetaljer
- ☒ Kromiosat
- ☒ Хромированные детали
- ☒ Części chromowane
- ☒ Chromované diely
- ☒ Krom alkatrészek
- ☒ Chromované diely
- ☒ Piese cromate
- ☒ Хромови части
- ☒ Kromirani deli
- ☒ Μέρη χρωμίου
- ☒ Krom parçalar



- ☒ Gleichen Vorgang auf der gegenüberliegenden Seite wiederholen.
- ☒ Repeat same procedure on opposite side.
- ☒ Opérer de la même façon sur l'autre face.
- ☒ Dezelfde handeling herhalen aan de tegenoverliggende kant.
- ☒ Ripetere il procedimento dall'altra parte.
- ☒ Repetir el mismo procedimiento en el lado contrario.
- ☒ Repetir alguns procedimentos no lado oposto.
- ☒ Gentag proceduren på den modstående side.
- ☒ Gjenta samme forløp på motliggende side.
- ☒ Upprepa samma process på motsatta sidan.
- ☒ Toista menettely vastakkaisella puolella.
- ☒ Повторить такие же действия на противоположной стороне.
- ☒ Powtórzyc te same czynności po przeciwnej stronie.
- ☒ Stejný postup opakujte na protilehlé straně.
- ☒ Ismételj meg a műveletet az ellentétes oldalon.
- ☒ Rovnaký postup zopakujte na protiláhej strane.
- ☒ Repetați același procedeu pe latura opusă.
- ☒ Повторете същите стъпки на срещуположната страна.
- ☒ Enak postopek ponovite na nasprotni strani.
- ☒ Επαναλάβετε την ίδια διαδικασία στην αντίθετη πλευρά.
- ☒ Aynı işlem adimlarını diğer tarafta da uygulayın.



- ☒ Zur Anbringung der Abziehbilder empfohlen.
- ☒ Recommended for affixing the decals.
- ☒ Recommandé pour l'application des décalcomanies.
- ☒ Aanbevolen voor het aanbrengen van de transfers.
- ☒ Raccomandato per l'applicazione delle decalcomanie.
- ☒ Recomendado para fijar bien las calcomanías.
- ☒ Recomendado para a fixação dos autocolantes.
- ☒ Anbefales til anbringelse af overføringsbillederne.
- ☒ Anbefales til å feste avtrekksbilder.
- ☒ Rekommenderad för montering av klisterdekalerna.
- ☒ Suositellaan siirtokuvien siirtämiseen.
- ☒ Рекомендується для нанесення переводних картинок.
- ☒ Zalecane do przyklejenia kalkomanii.
- ☒ Doporučujeme k umistění obtiskovacích obrázků.
- ☒ A matrica felhelyezéséhez ajánlható.
- ☒ Odporúča sa pre umiestnenie obľáčkových obrázků.
- ☒ Recomandat pentru aplicarea abțibildurilor.
- ☒ Препоръчва се за поставяне на ваденки.
- ☒ Pri nameštanju nalepnic priporočamo.
- ☒ Συνιστάται για την τοποθέτηση των χαλκομανιών.
- ☒ Çikartmaların takılması için önerilir.



- ☒ Nicht enthalten
- ☒ Not included
- ☒ Non fourni
- ☒ Behoort niet tot de levering
- ☒ Non incluso

- ☒ No incluido
- ☒ Não incluído
- ☒ Medfølger ikke
- ☒ Ikke inkludert
- ☒ Ingår ej
- ☒ Ei sisällä

- ☒ Ne содержится
- ☒ Nie wchodzi w zakres dostawy
- ☒ Není obsaženo
- ☒ Nem tartalmazza
- ☒ Neobsahuje

- ☒ Nu este inclus
- ☒ Ne se включва в комплекта
- ☒ Ni priloženo
- ☒ Δεν περιλαμβάνεται
- ☒ İçerilmiyor

OPTIONAL · OPTIONAL · EN OPTION · OPTIONEEL · OPCIONAL · OPTIONAL *

☞ Optional kann das Modell zusätzlich bemalt werden und wird damit zum ganz persönlichen Unikat. Wir empfehlen folgende Revell-Farben:

☞ The model can also be painted, which makes it completely unique. We recommend the following Revell paints:

☞ En option, il est aussi possible de peindre le modèle. Il devient alors une pièce vraiment unique et personnalisée. Nous vous recommandons les couleurs Revell suivantes :

☞ Optioneel kan het model aanvullend worden beschilderd om het een heel persoonlijke, unieke uitstraling te geven. Wij bevelen de volgende verf van Revell aan:

☞ Opcionalmente, el modelo se puede pintar para convertirlo en una pieza única personalizada. Recomendamos las siguientes pinturas de Revell:

☞ In via opzionale il modellino può essere verniciato per ottenere un esemplare del tutto personalizzato. Consigliamo di utilizzare i seguenti colori Revell:

☞ Opcionalmente, o modelo pode ser ainda pintado, dando-lhe um caráter pessoal único. Recomendamos as seguintes tintas Revell:

☞ Du kan vælge også at male modellen, som på den måde bliver personlig og unik. Vi anbefaler følgende Revell-farver:

☞ Du har mulighed til å gjøre modellen helt unik ved å male den. Vi anbefaler følgende Revell-farger:

☞ Modellen kan även målas och därmed bli en helt unik Unikat. Vi rekommenderar följande Revell-färger:

☞ Jos haluat yksilöllisen lopputuloksen, voit halutessasi myös maalata mallin. Suosittelemme käyttämään seuraavia Revell-maaleja:

☞ В качестве дополнения модель может быть окрашена, что придаст ей персональные, уникальные черты. Мы рекомендуем следующие цвета Revell:

☞ Opcjonalnie można dodatkowo pomalować model, który dzięki temu będzie całkowicie osobistym unikatem. Polecamy następujące farby Revell:

☞ Model se může dodatečně pomalovat, čímž vznikne zcela jedinečný originál. Doporučujeme použít barvy značky Revell:

☞ Opcióként a modell kiegészítő festéssel is ellátható, így igazán egyedivé tehető. Ehhez a következő Revell festékeket ajánljuk:

☞ Model sa môže dodatočne pomalovať, čím vznikne celkom jedinečný originál. Odporúčame použiť tieto farby značky Revell:

☞ Opțional, pentru un aspect unic, personalizat, pe model se poate aplica un strat suplimentar de vopsea. Vă recomandăm următoarele vopsele Revell:

☞ Опционално моделът може допълнително да бъде изпълнен в друг цвят и да се превърне в абсолютен уникат. Препоръчваме следните цветове на Revell:

☞ Po želji je moguće model dodatno prebarviti in ga tako spremiti v osebni unikat. Priporočamo naslednje barve Revell:

☞ Προαιρετικά μπορεί το μοντέλο να βαφεί και να γίνει ένα τελείως προσωπικό μοναδικό κομμάτι. Συνιστούμε τα παρακάτω χρώματα Revell:

☞ Opsiyonel olarak model boyanabilir ve benzersiz hale getirilebilir. Şu Revell renklerini tavsiye ediyoruz:

330

A

- ☞ Feuerrot seidenmatt
- ☞ Fiery red silk matt
- ☞ Rouge feu satiné mat
- ☞ Vuurrood zijdemat
- ☞ Rosso fuoco opaco satinato
- ☞ Rojo fuego mate satinado
- ☞ Vermelho fogo mate sedoso
- ☞ Ildröd silkematt
- ☞ Ildröd silkematt
- ☞ Eldröd sidenmatt
- ☞ Tulenpunainen silkkimatta
- ☞ Огненно-красный шелковисто-матовый
- ☞ Ognistoczerwony jedwabście matowy
- ☞ Ohnivě červená jemně matný
- ☞ Tűzpiros, fakóselymes
- ☞ Ohnivá červená hodvábne matný
- ☞ Roşu aprins satinat
- ☞ Огнечервено коприненоматово
- ☞ Ognjeno-rdeča svileni-mat
- ☞ Κόκκινο φωτιάς σατινέ
- ☞ Alev kırmızısi ipeksi mat

302

B

- ☞ Schwarz seidenmatt
- ☞ Black silk matt
- ☞ Noir satiné mat
- ☞ Zwart zijdemat
- ☞ Nero opaco satinato
- ☞ Negro mate satinado
- ☞ Preto mate sedoso
- ☞ Sort silkematt
- ☞ Sort silkematt
- ☞ Svart sidenmatt
- ☞ Musta silkkimatta
- ☞ Чёрный шелковисто-матовый
- ☞ Czarny jedwabście matowy
- ☞ Černá jemně matný
- ☞ Fekete, fakóselymes
- ☞ Čierna hodvábne matný
- ☞ Negru satinat
- ☞ Черно коприненоматово
- ☞ Črna svileni-mat
- ☞ Μαύρο σατινέ
- ☞ Siyah ipeksi mat

90

C

- ☞ Silber metallic
- ☞ Silver metallic
- ☞ Argent métallique
- ☞ Zilver metallic
- ☞ Argento metallico
- ☞ Plata metálico
- ☞ Prata metálico
- ☞ Sølv metallisk
- ☞ Sølv metallic
- ☞ Silver metallic
- ☞ Hopea metallinen
- ☞ Серебрянный металл
- ☞ Srebrny metaliczny
- ☞ Stříbrná metalizovaný
- ☞ Ezüstmetál
- ☞ Strieborná metaliza
- ☞ Argintiu metallic
- ☞ Сребро металик
- ☞ Srebrna kovinska
- ☞ Ασημί μεταλλικό
- ☞ Gümüş rengi metalik

07

D

- ☞ Schwarz glänzend
- ☞ Black gloss
- ☞ Noir brillant
- ☞ Zwart glanzend
- ☞ Nero lucido
- ☞ Negro brillante
- ☞ Preto brilhante
- ☞ Sort blank
- ☞ Sort glansende
- ☞ Svart blank
- ☞ Musta kiiltävä
- ☞ Чёрный глянцевоый
- ☞ Czarny błyszczący
- ☞ Černá lesklý
- ☞ Fekete, fényes
- ☞ Čierna lesklý
- ☞ Negru-strălucitor
- ☞ Черно гланцово
- ☞ Črna sijoča
- ☞ Μαύρο γυαλιστερό
- ☞ Siyah parlak

382

E

- ☞ Holzbraun seidenmatt
- ☞ Wood brown silk matt
- ☞ Brun bois satiné mat
- ☞ Houtbruin zijdemat
- ☞ Marrone legno opaco satinato
- ☞ Marrón madera mate satinado
- ☞ Castanho madeira mate sedoso
- ☞ Træbrun silkematt
- ☞ Trebrun silkematt
- ☞ Träbrun sidenmatt
- ☞ Puunruskea silkkimatta
- ☞ Древесно-коричневый шелковисто-матовый
- ☞ Brązowy w odcieniu drewna jedwabście matowy
- ☞ Dřevěná hnědá jemně matný
- ☞ Fa barna, fakóselymes
- ☞ Drevená hnedá hodvábne matný
- ☞ Maro lemnos satinat
- ☞ Дървеснокафяво коприненоматово
- ☞ Lesno-rjava svileni-mat
- ☞ Καφέ ανοιχτό σατινέ
- ☞ Ahsap rengi ipeksi mat

* ☞ Opcional
☞ Valgfritt
☞ Valgfritt

☞ Övrigt
☞ Valinnainen
☞ Дополнительно

☞ Opcja
☞ Volitelný krok
☞ Opcióként

☞ Volitelné
☞ Opțional
☞ Опция

☞ Dodatno
☞ Προαιρετικά
☞ Opsiyonel

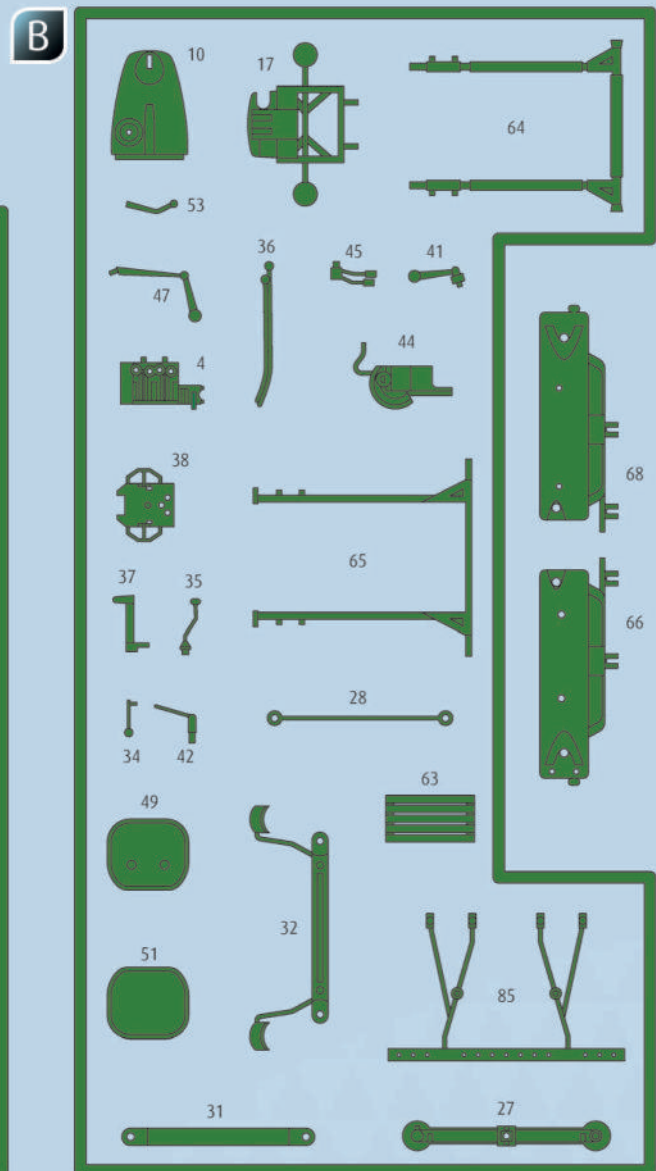
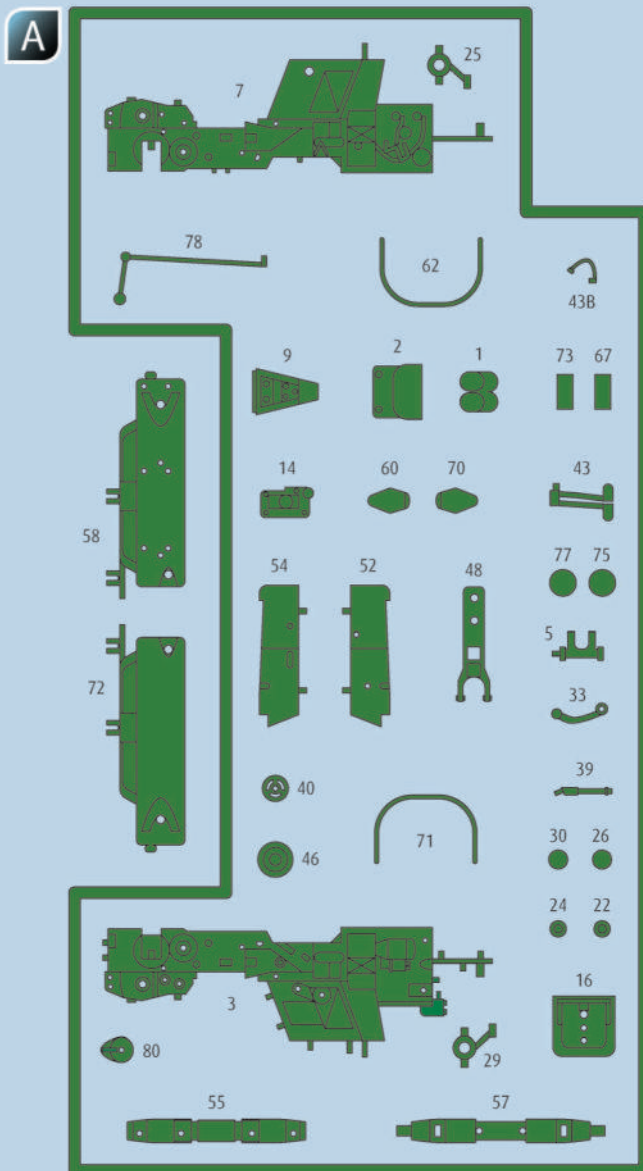

Ersatzteile benötigt?

Kein Problem. Einfach den Revell-Service mit Angabe von Artikel- und Teilenummer kontaktieren. Entweder unter service@revell.de oder Revell GmbH, Abteilung X, Henschelstr. 20-30, 32257 Bünde.*

*Wir bitten um Verständnis, dass eine Gewährleistung nur bei aktuellen Artikeln, die im Zeitraum der letzten 24 Monate erworben wurden, übernommen werden kann. Mit der Ersatzteil-Bestellung können Kosten z.B. für Verpackung und Versand entstehen. Ob diese Kosten anfallen wird im Vorfeld schriftlich durch unseren Service mitgeteilt. Das Angebot kann dann angenommen oder abgelehnt werden. Unfrei eingesandte Ersatzteil-Bestellungen werden von uns nicht angenommen! Dieser Direktservice gilt für die Länder Deutschland, Benelux, Österreich, Frankreich, Großbritannien. Ersatzteil-Bestellungen aus den übrigen Ländern werden über die jeweiligen Distributeure abgewickelt. Bitte kontaktieren Sie Ihren Händler.

Besoin de pièces de rechange ?

Il vous suffit de contacter le service Revell et d'indiquer la référence de l'article et de la pièce. Soit en écrivant par mail à france@revell.de (uniquement pour la France) ou par courrier à Revell GmbH, Département X, Henschelstr. 20-30, D-32257 Bünde.*

*La garantie s'applique pour les articles présents au catalogue et achetés au cours des 24 derniers mois. Merci de votre compréhension. La commande de pièces de rechange peut donner lieu à des frais supplémentaires, par ex. pour l'emballage et le port. Notre service client vous en informera au préalable par écrit. Vous pourrez accepter ou refuser le devis. Nous n'acceptons pas les commandes de pièces de rechange envoyées sans affranchissement ! Ce service direct est valable pour les pays suivants : Allemagne, Benelux, Autriche, France, Grande-Bretagne. Les commandes de pièces en provenance d'autres pays sont traitées par les distributeurs correspondants. Veuillez contacter votre revendeur.

Need spare parts?

No problem. Contact Revell Service with the item number and part numbers you need: service@revell.de or Revell GmbH, Unit 10, Old Airfield Industrial Estate, Cheddington Lane, Tring, Herts, HP23 4QR, Great Britain.*

*We request your understanding that a warranty can only be accepted for current articles which have been purchased in the last 24 months. Orders for spare parts may also be subject to costs for packaging and shipping. You will be notified in advance by our Service department if such costs are incurred. The offer can then be accepted or rejected. We will not be able to process any postal requests unless correct postage has been applied to mailing! This direct service applies to the countries: Germany, Benelux, Austria, France, and the United Kingdom. Spare part orders from other countries are processed by the local distributors. Please contact your dealer.

Hebt u reserveonderdelen nodig?

Geen probleem! Neem eenvoudig contact op met de klantenservice van Revell en geef ons het artikel- en onderdeelnummer door. U kunt ons bereiken op service@revell.de of per post: Revell GmbH, Afdeling X, Henschelstr. 20-30, 32257 Bünde.*

*Wij vragen uw begrip voor de omstandigheid, dat er alleen garantie kan worden geboden voor actuele artikelen, die in de afgelopen 24 maanden zijn gekocht. Met het bestellen van reserveonderdelen kunnen kosten gemoeid zijn, bijv. voor verpakking en verzending. U wordt vooraf schriftelijk door onze klantenservice op de hoogte gesteld als er kosten zouden ontstaan. Het aanbod kan dan worden aangenomen of afgewezen. Wij nemen geen ongefrankeerde bestellingen van reserveonderdelen aan! Deze rechtstreekse service wordt verleend in de landen Duitsland, de Benelux, Oostenrijk, Frankrijk en Groot-Brittannië. Bestellingen van reserveonderdelen in de overige landen worden afgewikkeld via de betreffende distributeurs. Neem hiervoor contact op met uw verkoper.

C

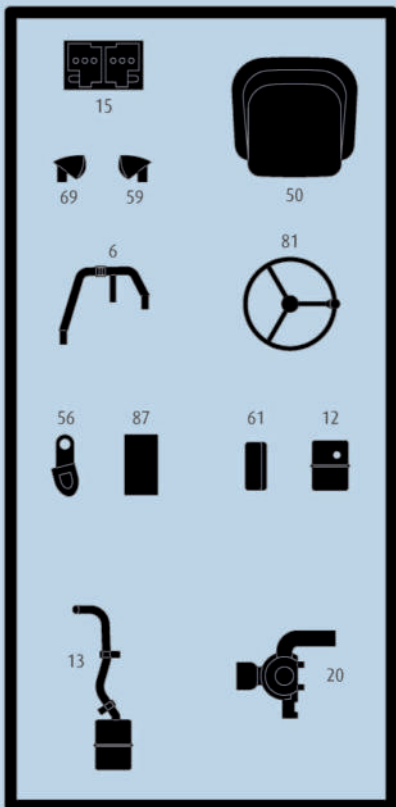

D
Chrome

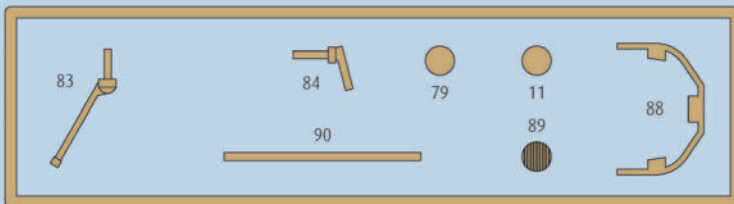

E

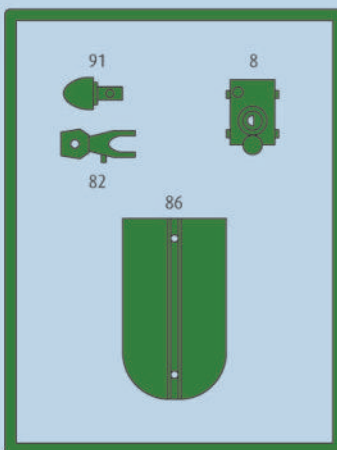

F
Clear



G

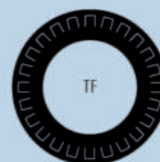
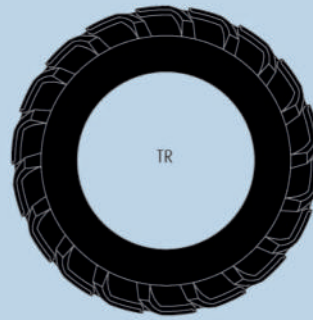
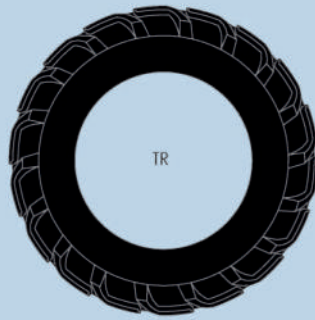
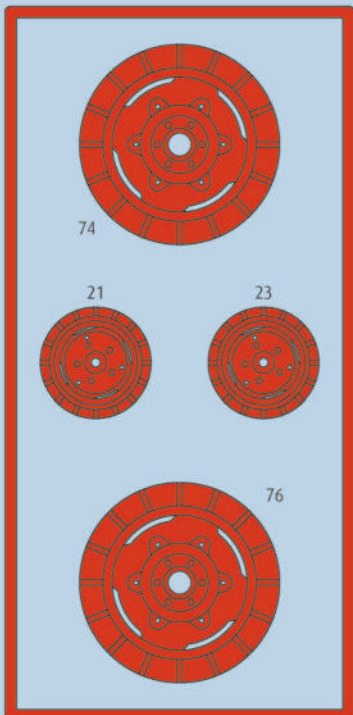

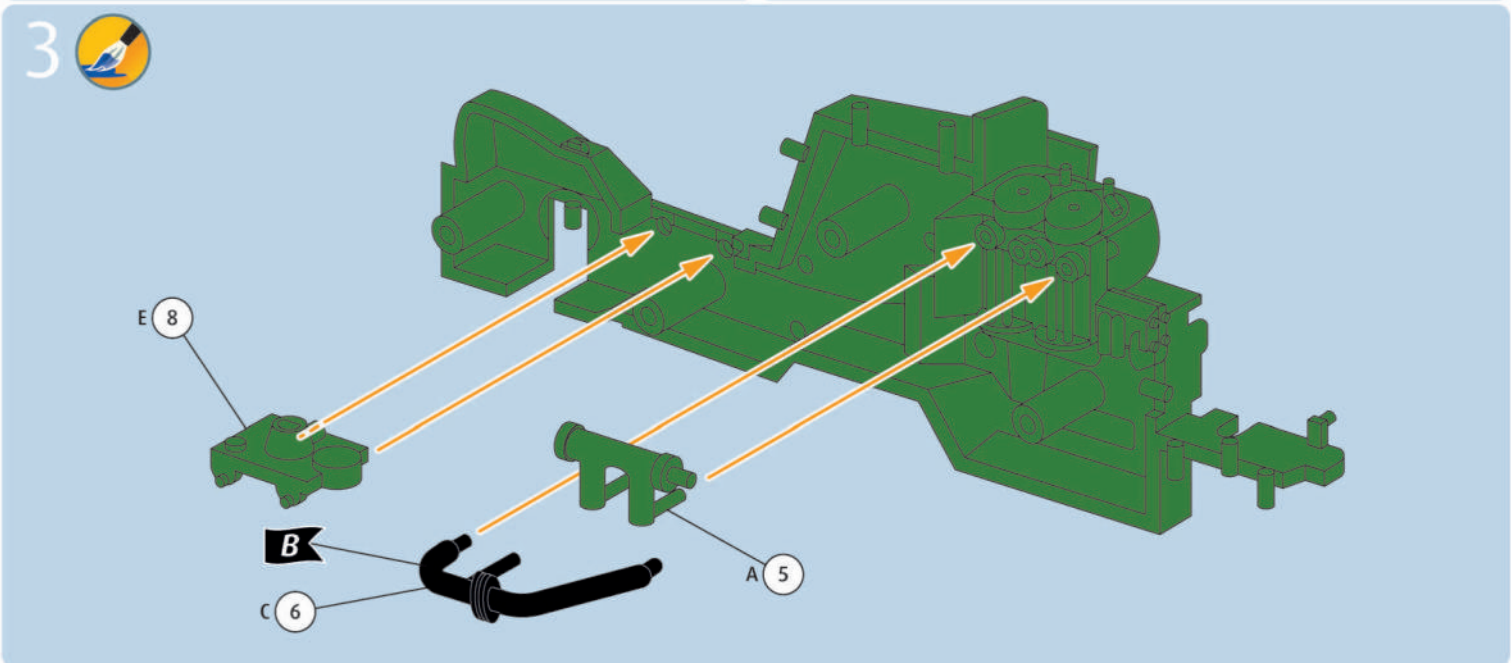
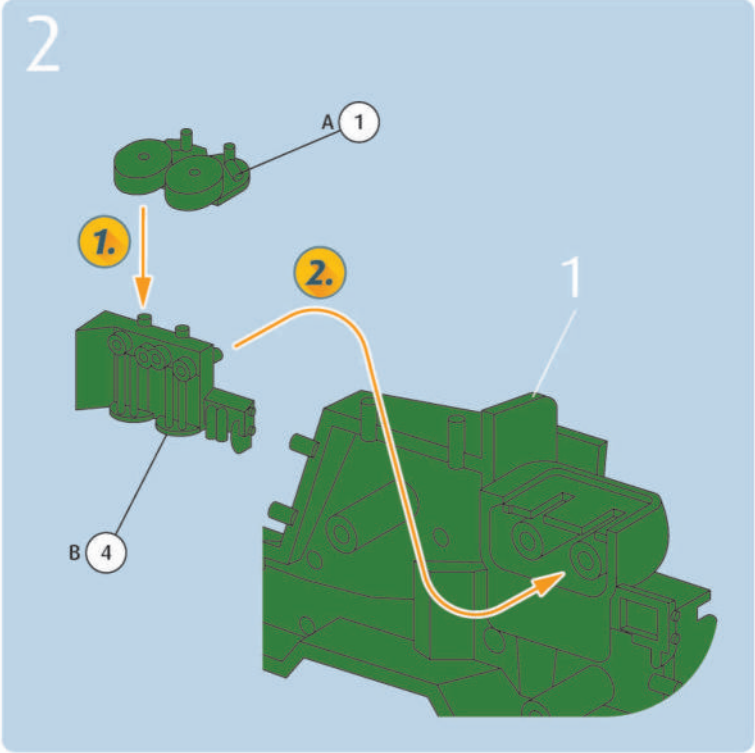
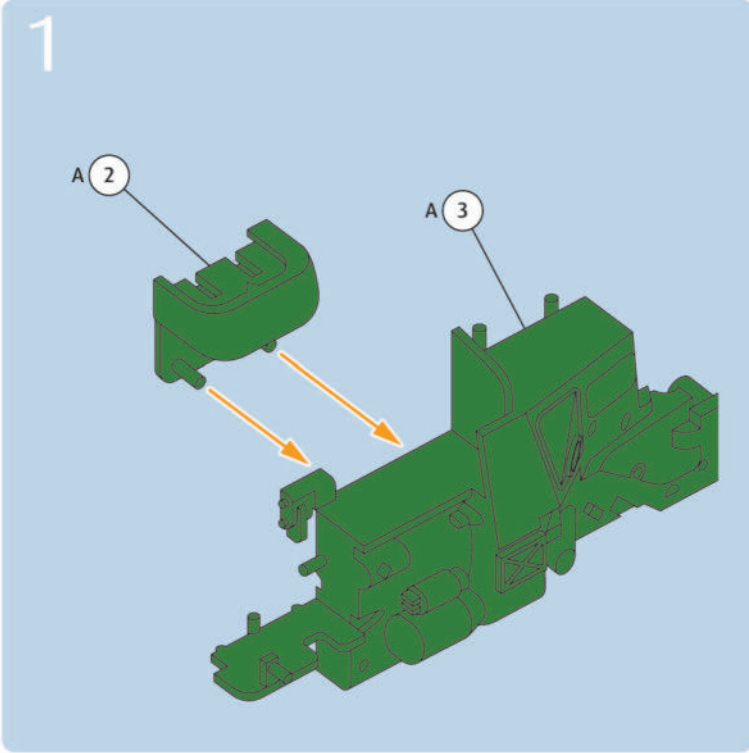

5 



6 

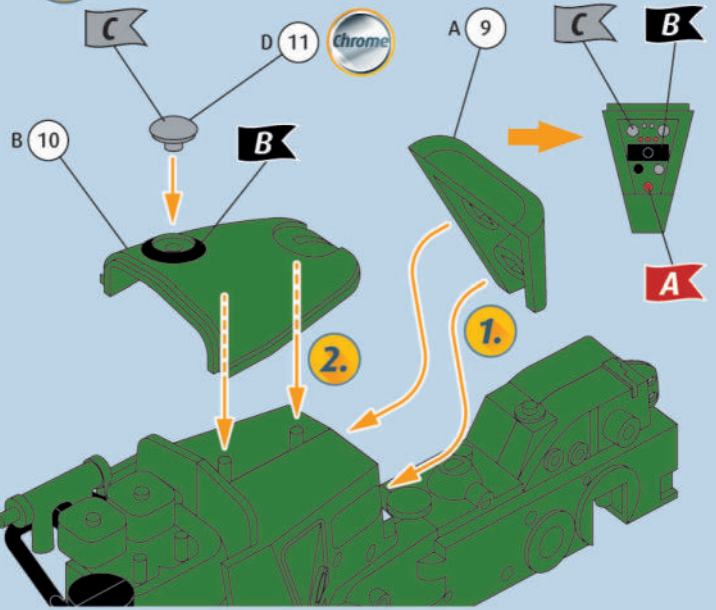

7 

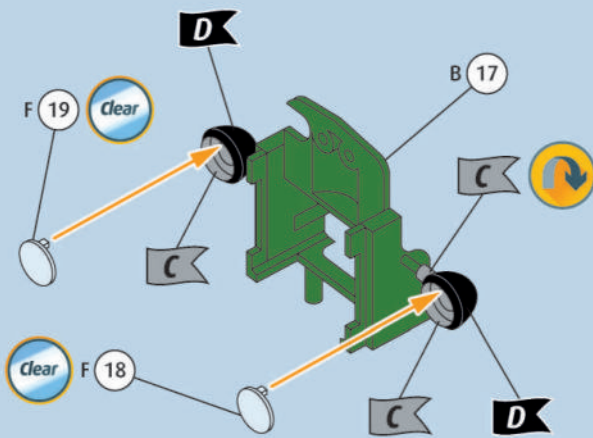

8

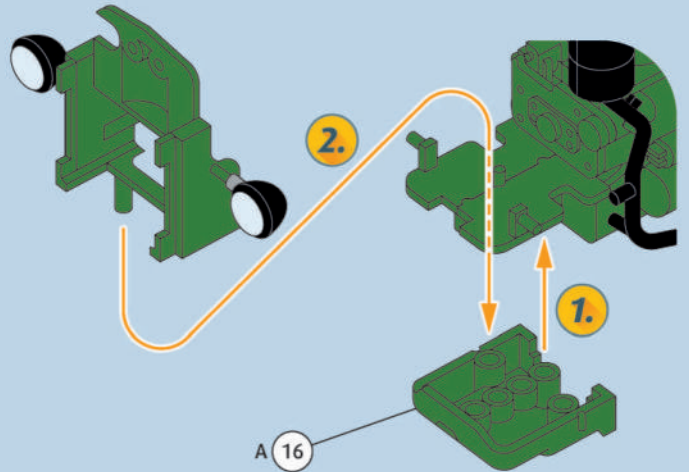

9   

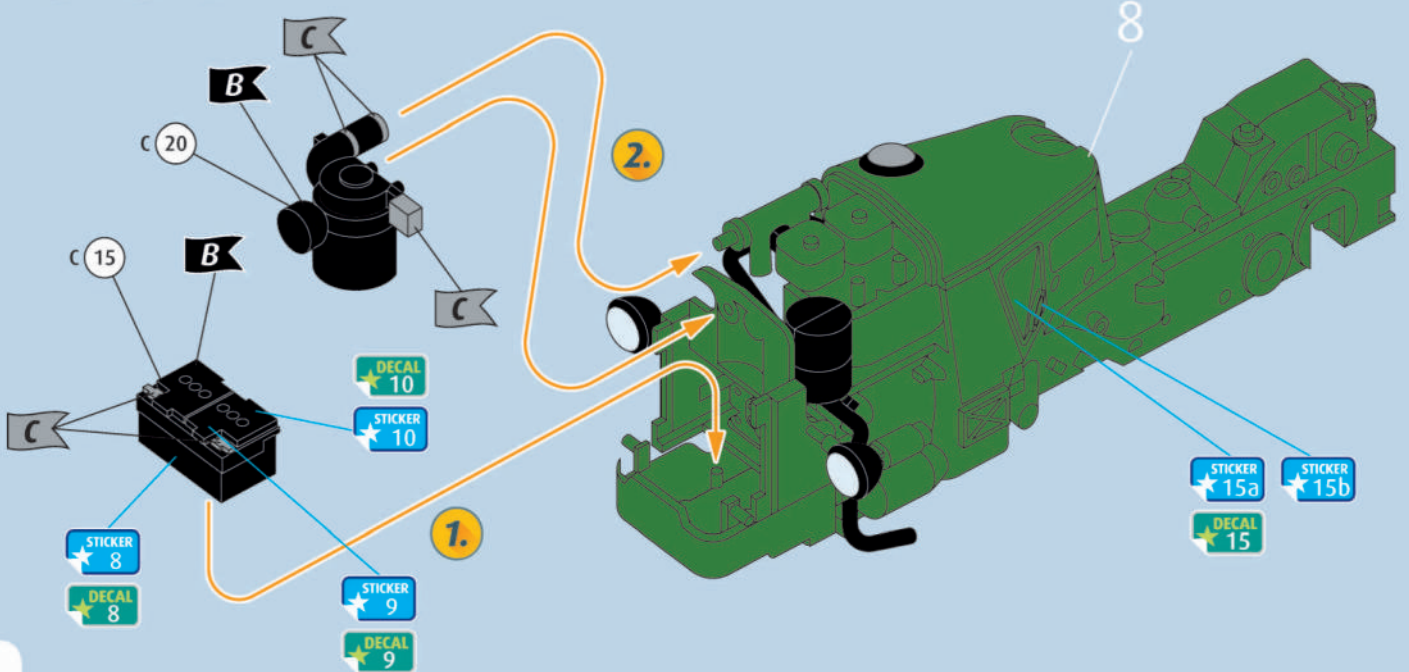

10

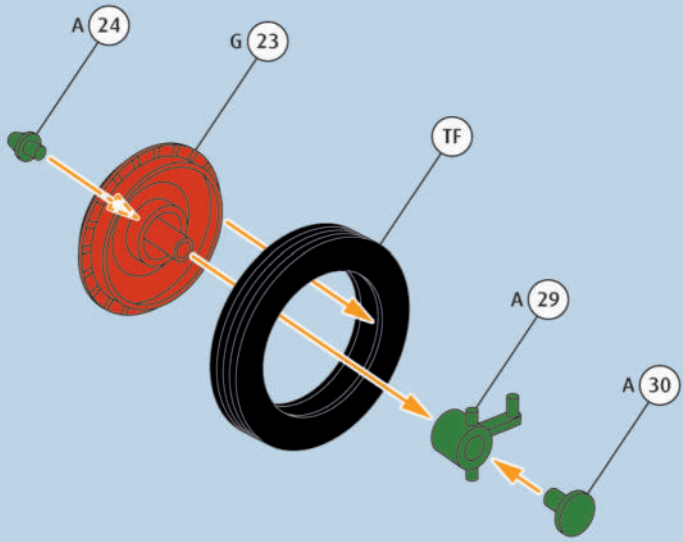

11

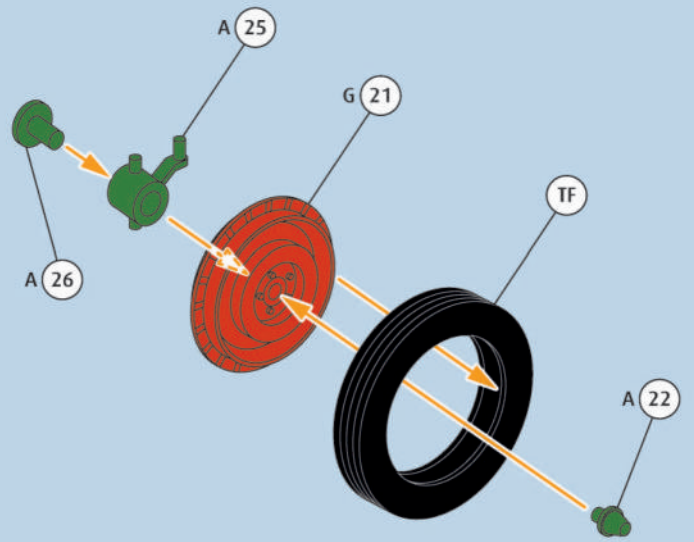

12

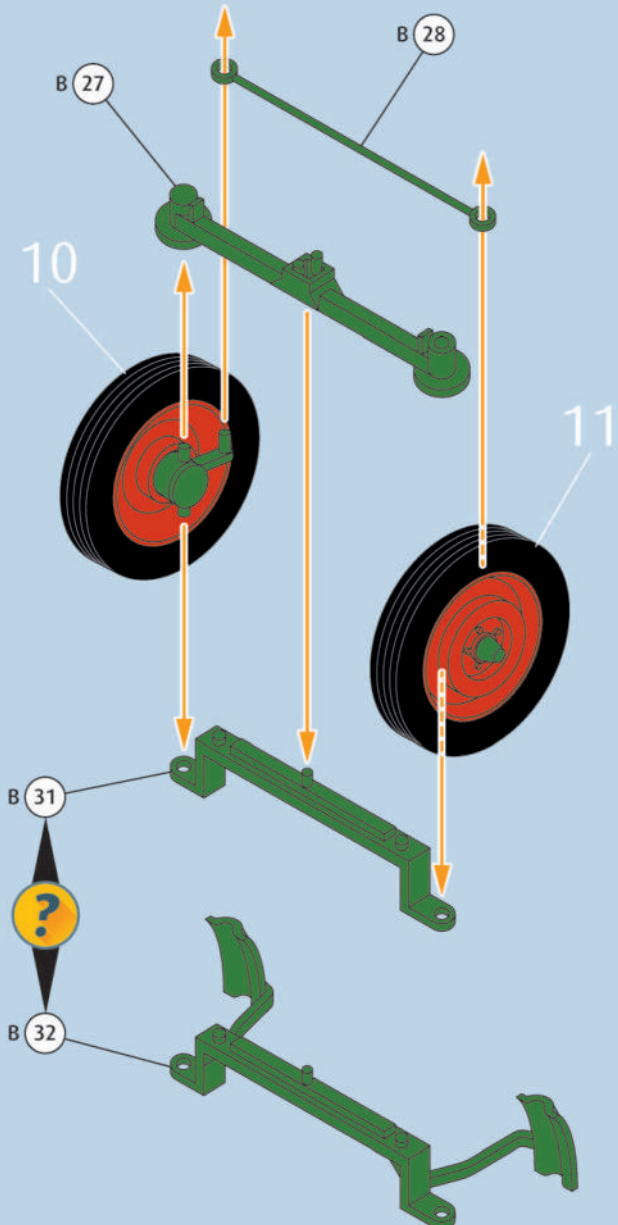

13

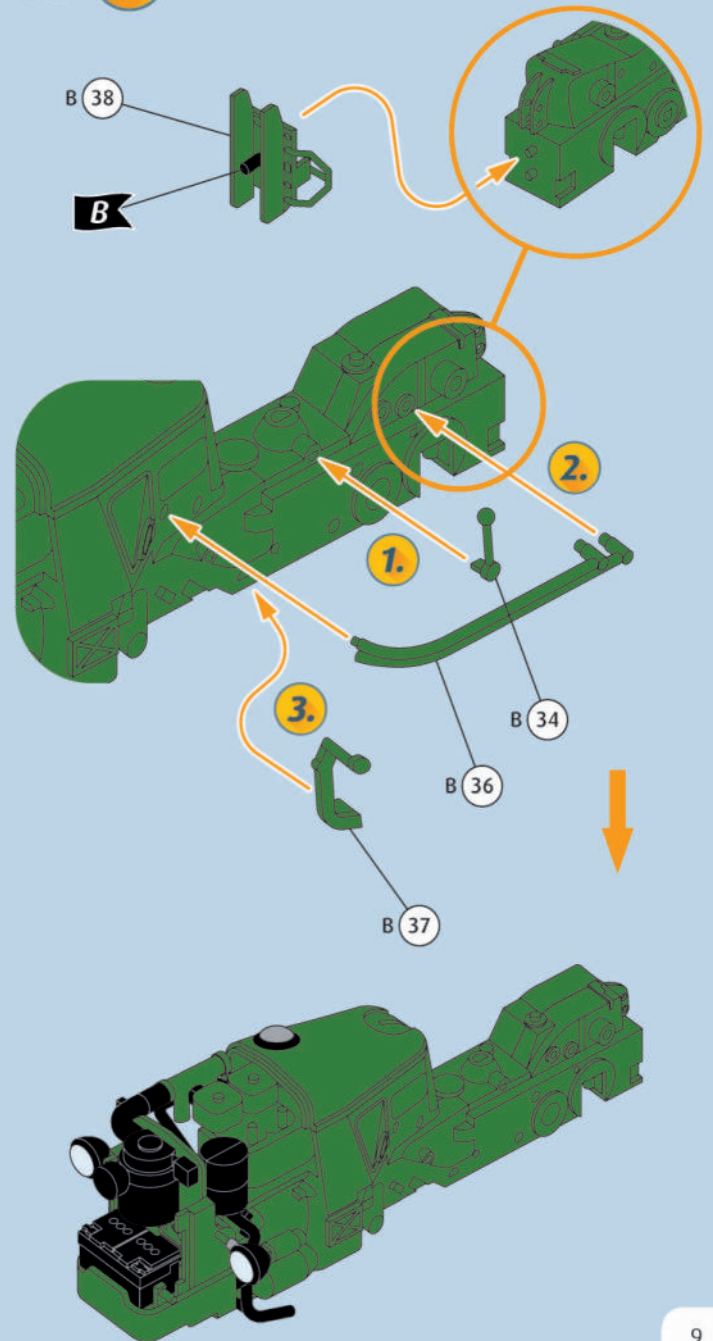

14

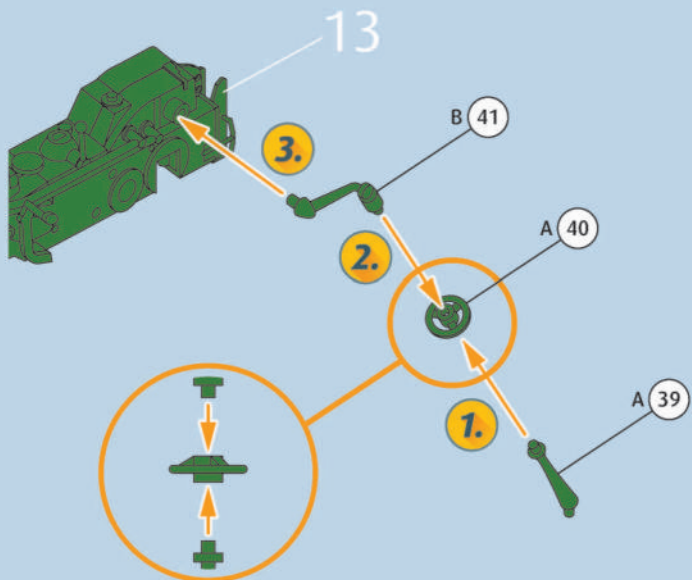

15

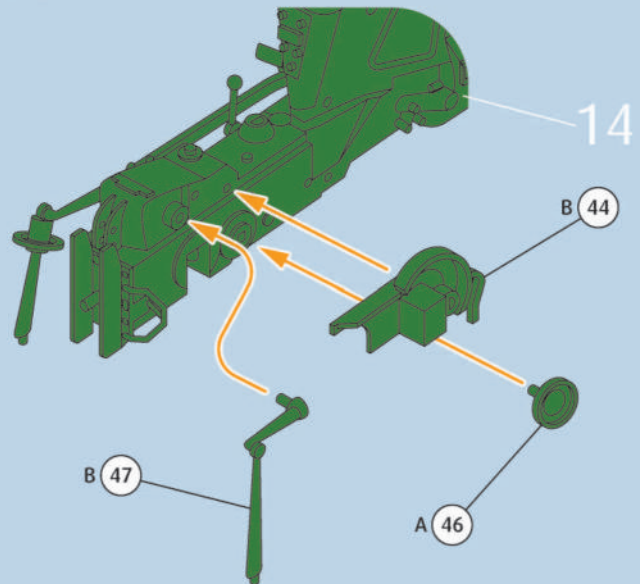

16



17

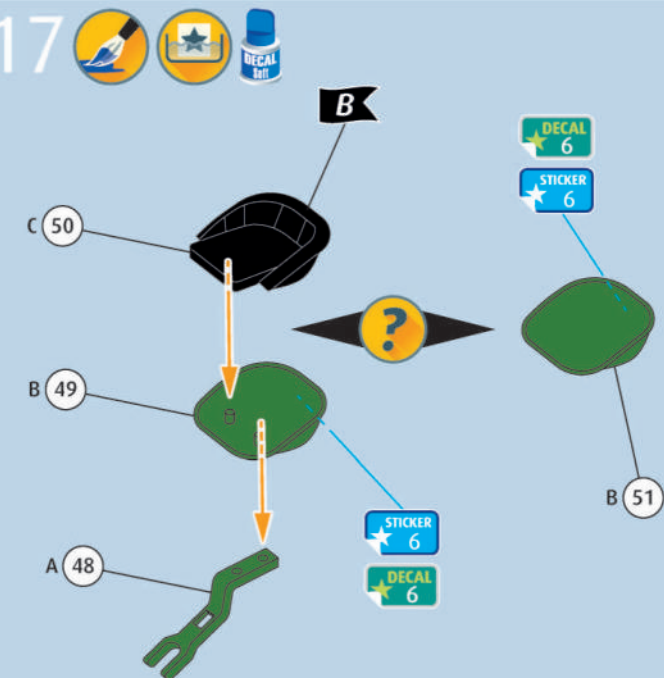

18

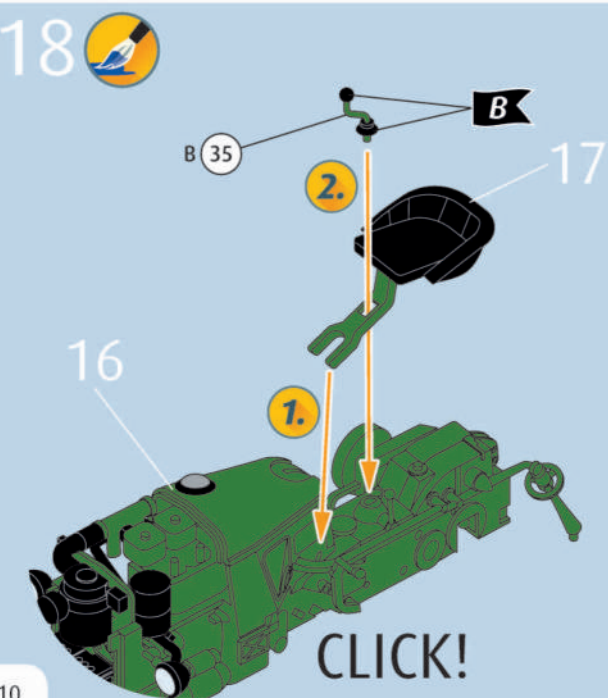

19

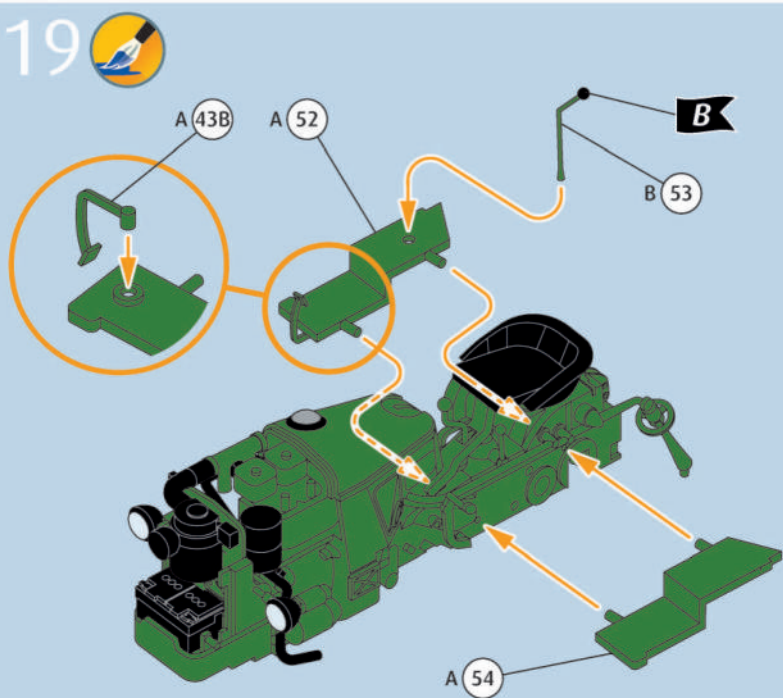

20

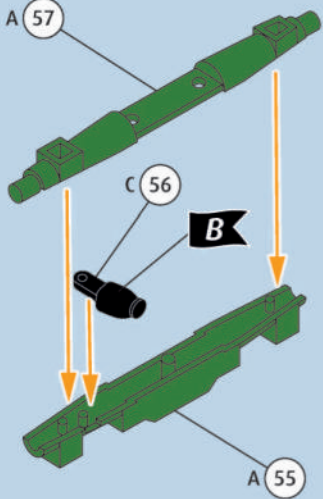

21

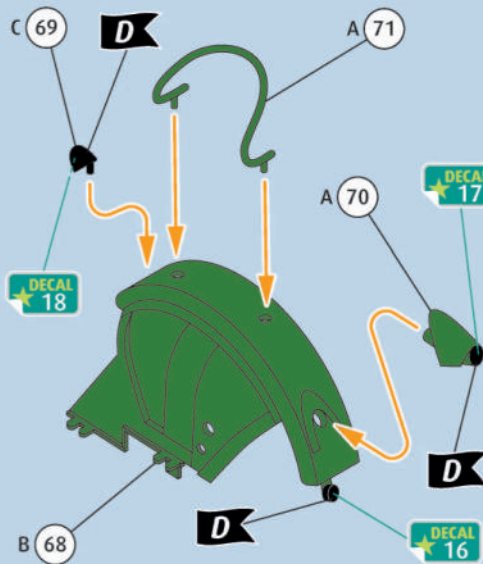

22

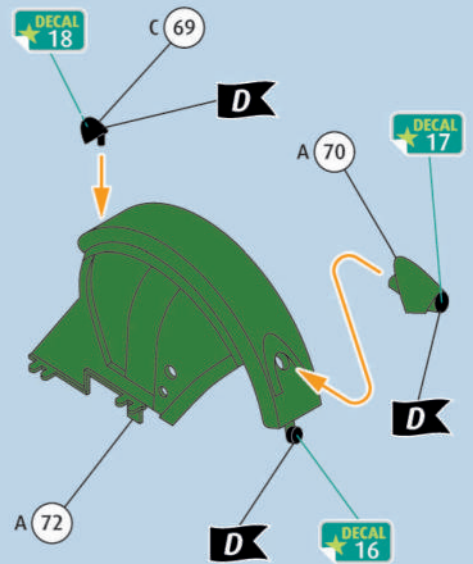

23

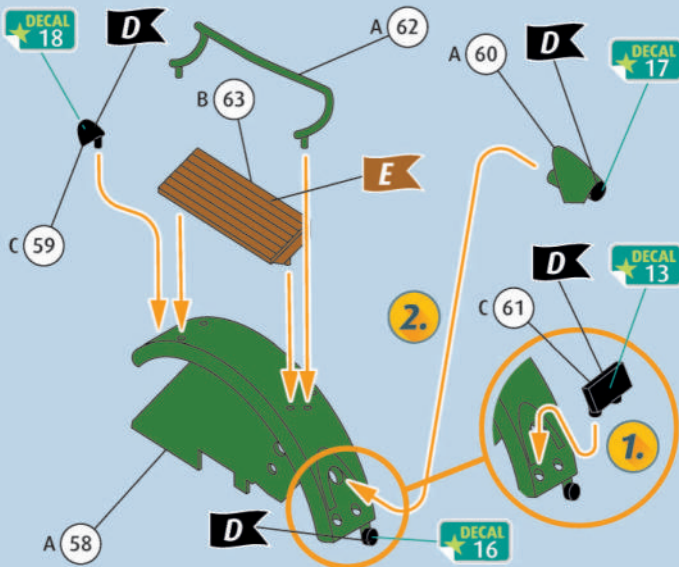

24

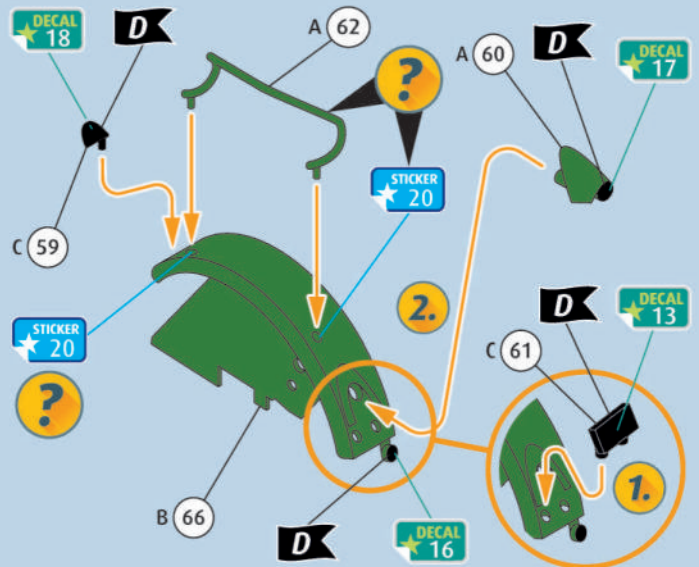

25

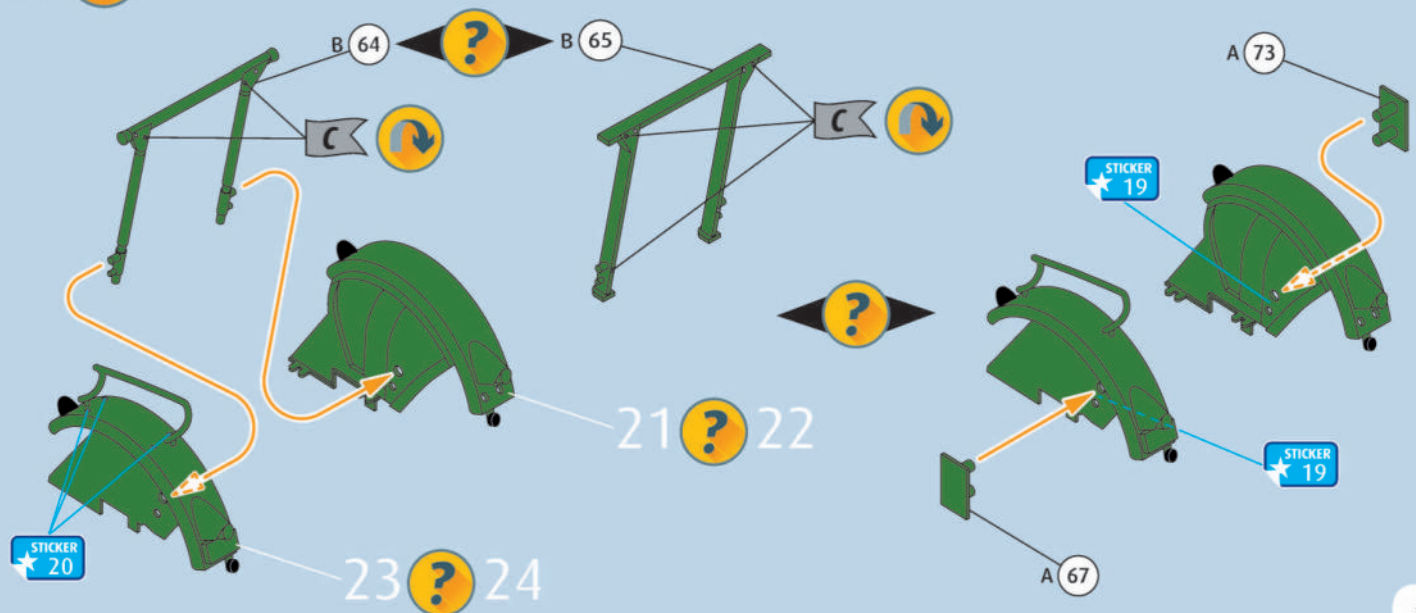

26

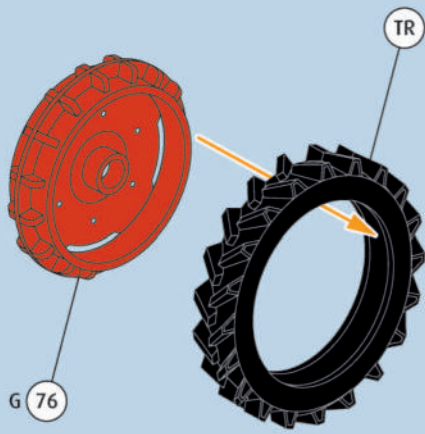

27

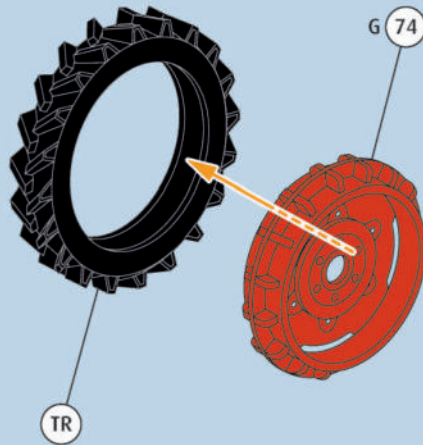

28

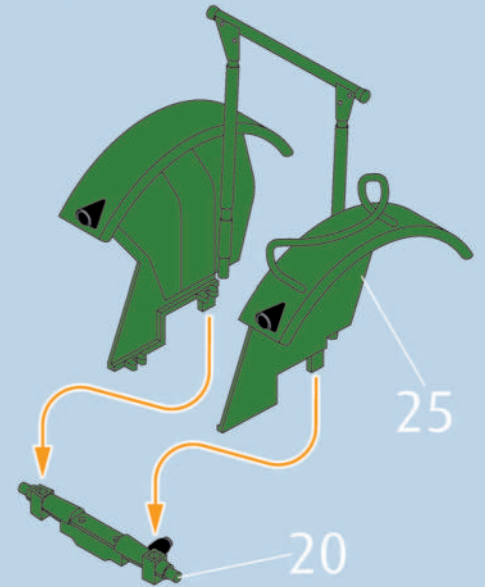

29

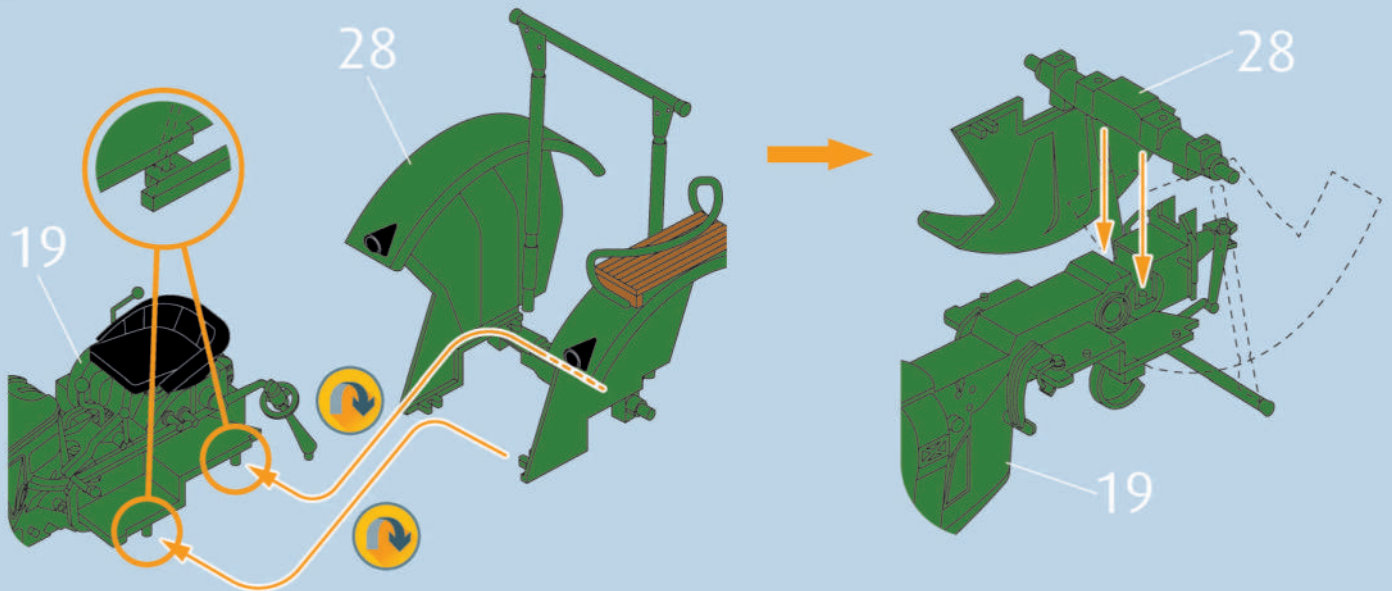

30

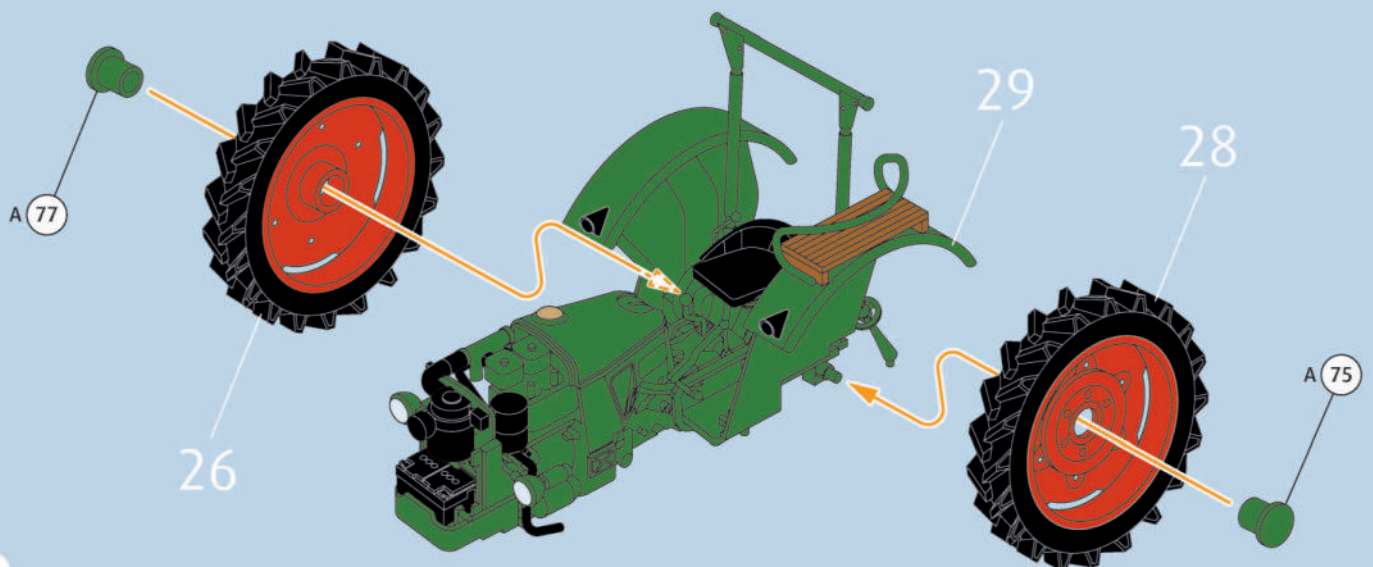

31

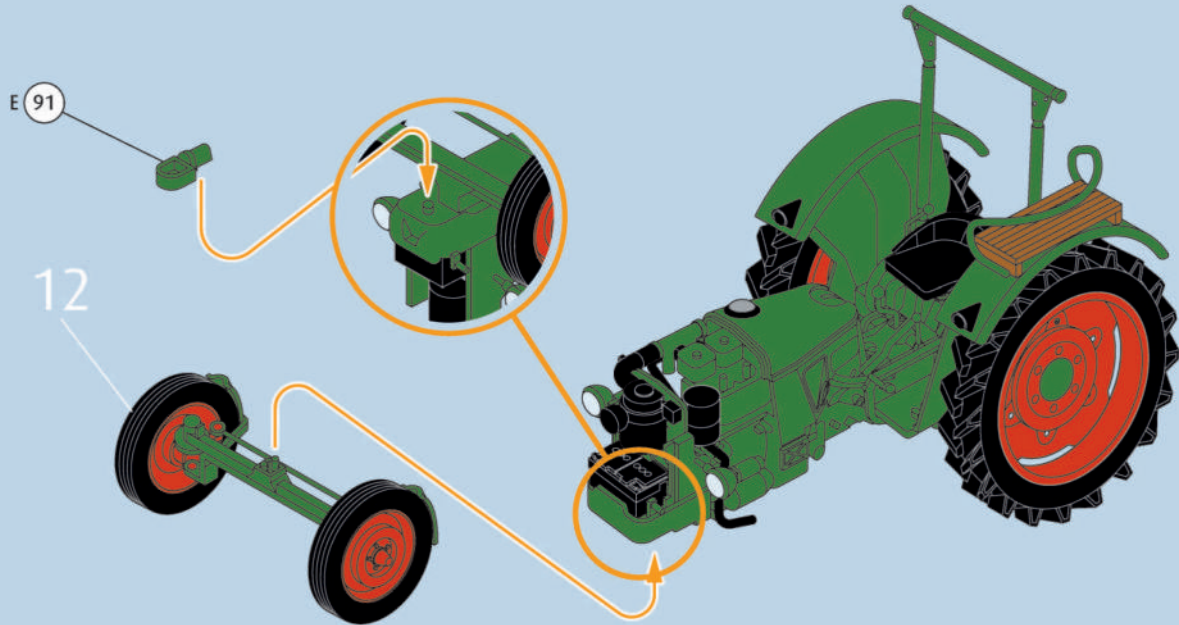

32

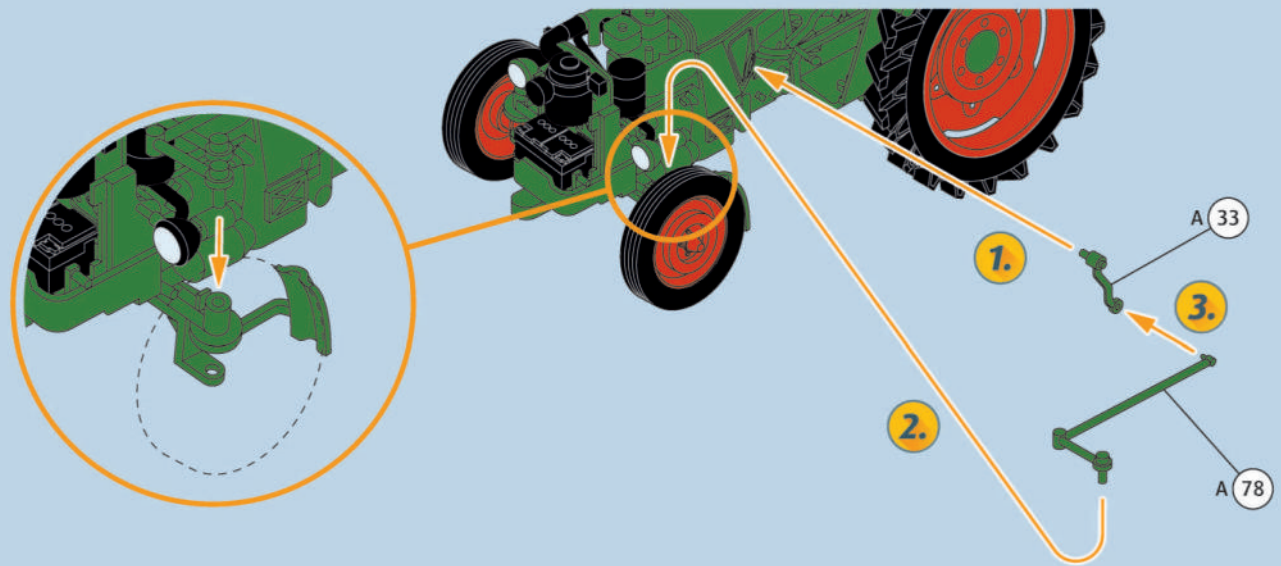

33

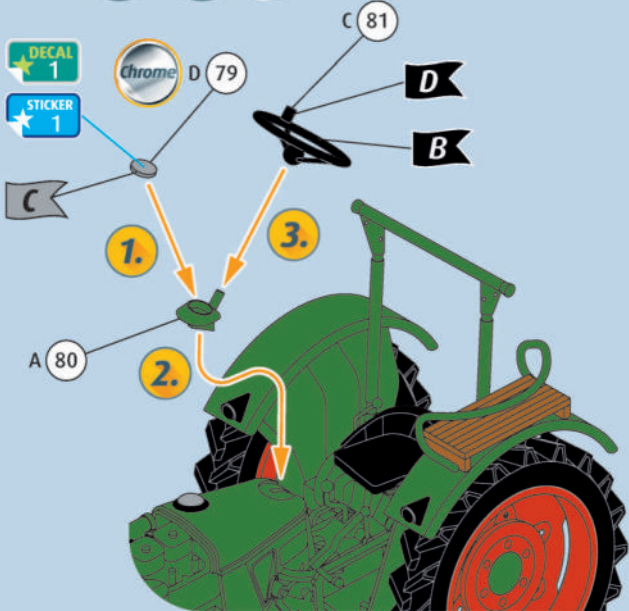

34

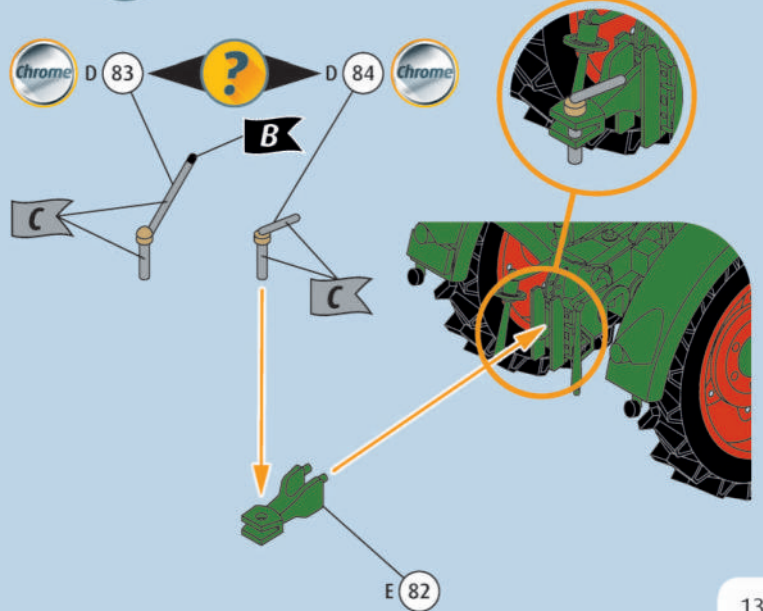

35

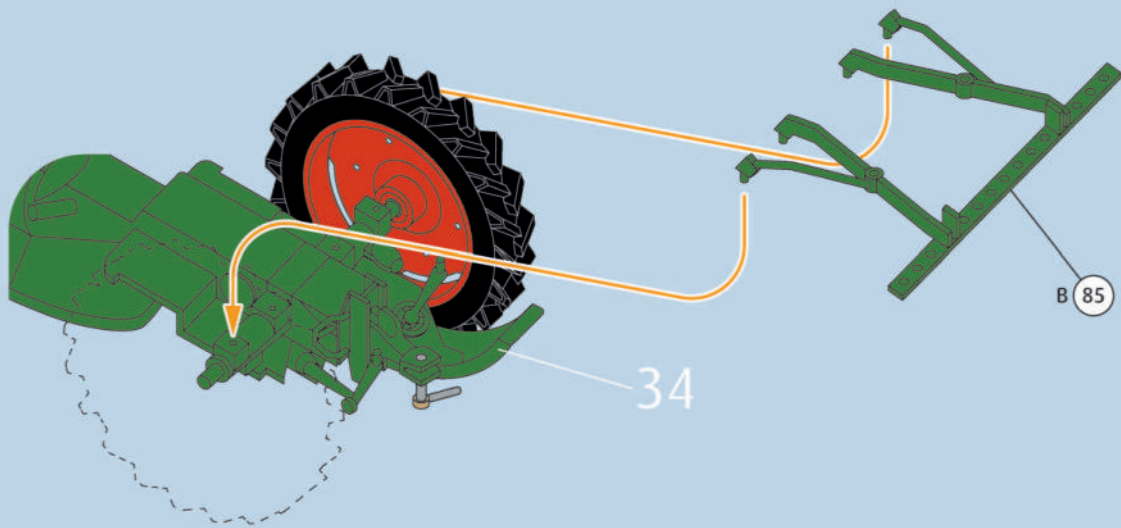

36

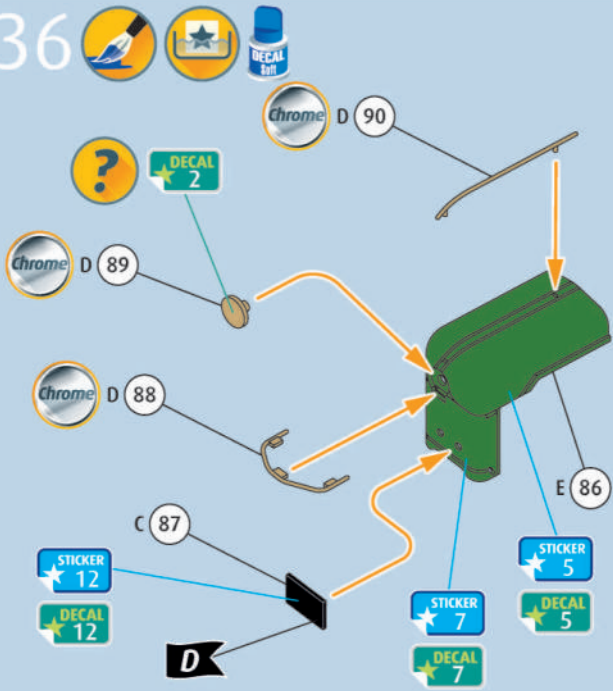

37

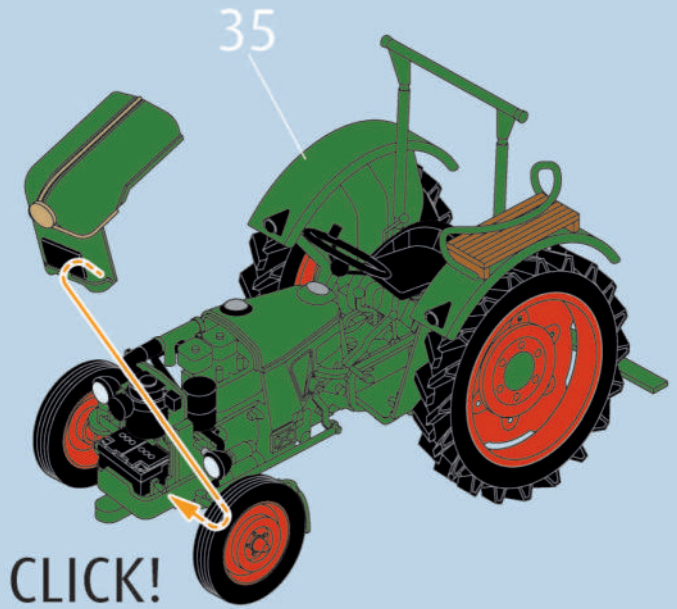

38

