



06718-0379

LEVEL 3

1 2 3 4 5



MILLENNIUM FALCON™

Beiliegenden Sicherheitstext beachten / Please note the enclosed safety advice

- (DE) Beiliegenden Sicherheitstext beachten und nachschlagbereit halten.
 (EN) Please note the enclosed safety advice and keep safe for later reference.
 (FR) Respecter les consignes de sécurité ci-jointes et les conserver à portée de main.
 (NL) Houdt u aan de bijgaande veiligheidsinstructies en hou deze steeds bij de hand.
 (IT) Seguire le avvertenze di sicurezza allegate e tenerle a portata di mano.
 (ES) Observar y siempre tener a disposición este texto de seguridad adjunto.
 (PT) Ter em atenção o texto de segurança anexo e guardá-lo para consulta.
- (DK) Overhold vedlagte sikkerhedsanvisninger og hav dem liggende i nærheden.
 (NO) Ha alltid vedlagt sikkerhetstekst klar til bruk.
 (SE) Beakta bifogad säkerhetstext och håll den i beredskap.
 (FI) Huomioi ja säilytä oheiset varoitukset.
 (RU) Соблюдать технику безопасности, сохранить инструкцию для дальнейших обращений.
 (PL) Przestrzegać załączonego tekstu dotyczącego bezpieczeństwa i mieć go zawsze pod ręką.
 (CZ) Dodržujte tento příložený bezpečnostní text a mějte ho po ruce.
 (HU) A mellékelt biztonsági szöveget vegye figyelembe és tartsa fellapozásra készen.
- (SK) Rešpektujte priložený bezpečnostný text a uchovajte ho pre budúce použitie.
 (RO) Respectați textul de siguranță atașat și păstrați-l la îndemână.
 (BG) Спазвайте приложения текст за безопасност и го дръжте под ръка за справки.
 (SI) Priloga varnostna navodila izvajajte in jih hranite na vsem dostopnem mestu.
 (GR) Λάβετε υπόψη σας το συννημένο κείμενο ασφαλείας και φυλάξτε το ώστε να ανατρέχετε σε αυτό όποτε χρειάζεται.
 (TR) Ektekiğüvenlik talimatlarını dikkate alıp, bakabileceğiniz bir şekilde muafaza ediniz.

© 2018 Revell GmbH, Henschelstr. 20-30, D-32257 Bünde.

REVELL IS THE REGISTERED TRADEMARK OF REVELL GMBH, GERMANY. www.revell.de

© & ™ Lucasfilm Ltd.

www.starwars.com

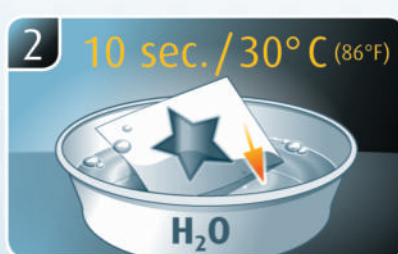
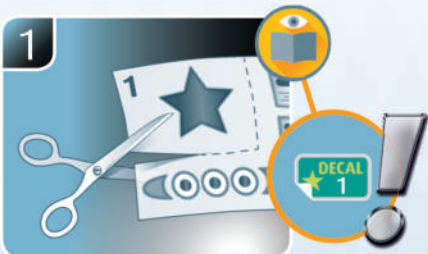
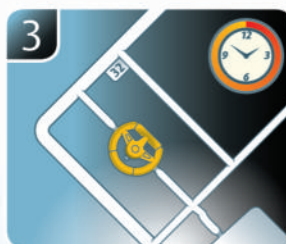
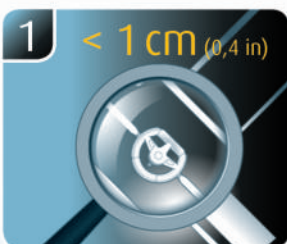
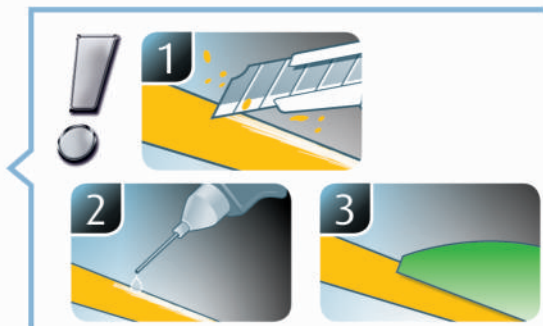
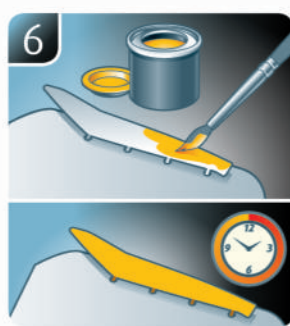
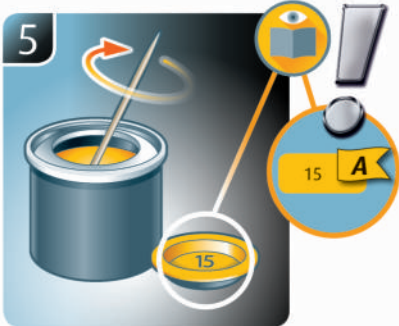
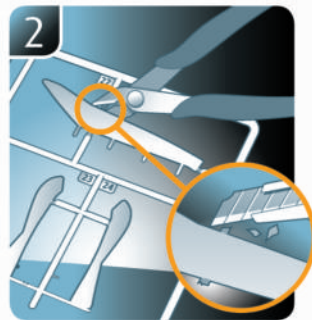
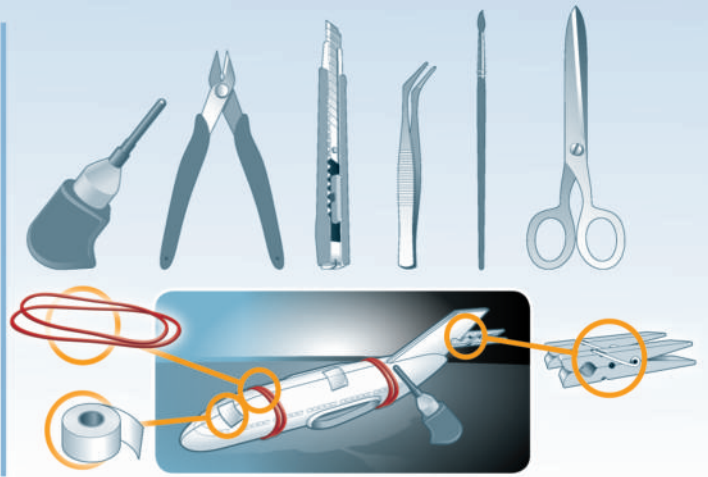

- ☞ Weitere Tipps und Tricks.
- ☞ Additional tips and tricks.
- ☞ Conseils et astuces supplémentaires.
- ☞ Andere tips en trucs.
- ☞ Ulteriori consigli e suggerimenti.
- ☞ Consejos y sugerencias adicionales.
- ☞ Mais dicas e truques.

- ☞ Flere tips og tricks.
- ☞ Flere tips og tricks.
- ☞ Ytterligare tips och tricks.
- ☞ Lisää vinkkejä ja niksejä.
- ☞ Другие советы и хитрости.
- ☞ Dalsze wskazówki i sugestie.
- ☞ Další tipy a rady.
- ☞ További ötletek és fogások.
- ☞ Dalsie tipy a triky.
- ☞ Alte sfaturi și trucuri.

- ☞ Други полезни съвети и трикове.
- ☞ Nadaljnji nasveti in zvižaje.
- ☞ Πρόσθετες συμβουλές και κόλπα.
- ☞ Diğer öneriler ve ipuçları.

www.revell.de



- DE Kleben
- FR Glue
- FR Collier
- NL Lijmen
- IT Incollare
- ES Pegamento
- PT Colar
- DK Lim
- NO Lime
- SE Limma
- FI Liimaa
- RU Клеить
- PL Przykleić
- CZ Slepění
- HU Ragasztás rá
- SK Lepiť
- NO Lipiti
- BG Залепете
- SI Prilepite
- GR ΚΟΛΛΗΣΤΕ
- TR Yapıştırma



- DE Nicht kleben
- FR Don't glue
- FR Ne pas coller
- NL Niet lijmen
- IT Non incollare
- ES No pegamento
- PT Não colar
- DK Lim ikke
- NO Ikke lime
- SE Limma inte
- FI Älä liimaa
- RU Не клеить
- PL Nie przyklejać
- CZ Nelepít
- HU Ne ragasztás rá
- SK Nelepít
- NO Nu lipiti
- BG Не лепете
- SI Ne lepíte
- GR Μην κολλήσετε
- TR Yapıştırmayın



- DE Bemalen
- FR Paint
- FR Peindre
- NL Beschilderen
- IT Colorare
- ES Pintar
- PT Pintar
- DK Mal
- NO Male
- SE Måla
- FI Maalaa
- RU Раскрасить
- PL Pomalować
- CZ Pomalovat
- HU Fesse be
- NO Natrief
- NO Vopsiñi
- BG Боядисайте
- SI Robarvajte
- GR Βάψτε
- TR Boyama



- DE Zusammenbau Reihenfolge.
- FR Sequence of assembly.
- FR Ordre d'assemblage.
- NL Volgorde van montage.
- IT Sequenza di assemblaggio.
- ES Secuencia de montaje.
- PT Sequência de montagem.
- DK Samlerækkefølge.
- NO Monteringsrekkefølge.
- SE Monteringsordningsföljd.
- FI Kokoamisjärjestys.
- RU Последовательность сборки.
- PL Kolejność montażu.
- CZ Pořadí složení.
- HU Összerakási sorrend.
- BG Poradie zostavenia.
- NO Ordinea asamblării.
- BG Последовательност на сглобяване.
- SI Vrstni red sestavljanja.
- GR Σειρά τοποθέτησης.
- TR Parçaları birleştirme sırası.



- DE Wahlweise
- FR Optional
- FR Facultatif
- NL Naar keuze
- IT Facoltativamente
- ES Opcional
- PT Opcional
- DK Valgfri
- NO Valgfritt
- SE Valfri
- FI Valinnaisesti
- RU На выбор
- PL Opcjonalnie
- CZ Volitelně
- HU Választás szerint
- SK Alternativne
- NO Optional
- BG По избор
- SI Izbirno
- GR Προαιρετικά
- TR Opsiyonel



- DE Unregelmäßig mit einem Pinsel verteilen.
- FR Apply unevenly with a brush.
- FR Enduire irrégulièrement au pinceau.
- NL Met penseel onregelmatig verdelen.
- IT Distribuire in modo irregolare con un Pennello.
- ES Aplicar uniformemente con una brocha.
- PT Aplicar irregularmente com um pincel.
- DK Fordel ujævnt med en pensel.
- NO Fordel ujevnt med en pensel.
- SE Fördelas oregelbundet med en pensel.
- FI Levitä epätasaisesti pensselillä.
- RU Неравномерно распределить кисточкой.
- PL Rozmieścić nieregularnie za pomocą pędzla.
- CZ Nepravidelně rozdělte štětcem.
- HU Oszlassa el szabálytalanul ecsettel.
- SK Stetcom nerovnomerne roztríte.
- NO Distribuiñi neuniform cu o pensulă.
- BG Разпределете неравномерно с четка.
- SI Neenakomerno razdelite s čopičem.
- GR Απλώστε ανομοιόμορφα με ένα πινέλο.
- TR Fırça ile dengesiz bir şekilde dağıtın.



- DE Gleichen Vorgang auf der gegenüberliegenden Seite wiederholen.
- FR Repeat same procedure on opposite side.
- FR Opérer de la même façon sur l'autre face.
- NL Dezelfde handeling herhalen aan de tegenoverliggende kant.
- IT Ripetere il procedimento dall'altra parte.
- ES Repetir el mismo procedimiento en el lado contrario.
- PT Repetir alguns procedimentos no lado oposto.
- DK Gentag proceduren på den modsatte side.
- NO Gjenta samme forløp på motliggende side.
- SE Upprepa samma process på motsatta sidan.
- FI Toista menettely vastakkaisella puolella.
- RU Повторить такие же действия на противоположной стороне.
- PL Powtórzyć te same czynności po przeciwnej stronie.
- CZ Stejný postup opakujte na protilehlé straně.
- HU Ismételje meg a műveletet az ellentétes oldalon.
- SK Rovnaký postup zopakujte na protifahej strane.
- NO Repetati același procedeu pe latura opusă.
- BG Повторете същите стъпки на срещуположната страна.
- SI Enak postopek ponovite na nasprotni strani.
- GR Επαναλάβετε την ίδια διαδικασία στην αντίθετη πλευρά.
- TR Aynı işlem adimlarını diğer tarafta da uygulayın.



- DE Bauanleitung sorgfältig lesen.
- FR Read the assembly instructions carefully.
- FR Lisez attentivement les instructions de montage.
- NL Bouwinstructies zorgvuldig doorlezen.
- IT Leggere attentamente le istruzioni per il montaggio.
- ES Lea cuidadosamente las instrucciones de montaje.
- PT Ler atentamente as instruções de montagem.
- DK Læs byggevejledningen omhyggeligt.
- NO Les byggeanvisningen nøye.
- SE Monteringsinstruktionerna skall läsas noggrant.
- FI Lue kokoamisohje huolellisesti.
- RU Внимательно прочитайте инструкцию по сборке.
- PL Dokładnie przeczytać instrukcję montażu.
- CZ Přečtěte si pečlivě návod k obsluze.
- HU Figyelmesen olvassa el a szerelési útmutatót.
- SK Návod na montáž starostlivo prečítajte.
- NO Citijti cu atenție instrucțiunile de montare.
- BG Прочетете внимателно упътването за монтаж.
- SI Skrbno preberite navodila za sestavo.
- GR Διαβάστε προσεκτικά τις οδηγίες κατασκευής.
- TR Yapı kılavuzunu dikkatle okuyun.



- DE Klarsichtteile
- FR Clear parts
- FR Pièces transparentes
- NL Transparente onderdelen
- IT Parti trasparenti
- ES Piezas transparentes
- PT Peças transparentes
- DK Klare dele
- NO Klare deler
- SE Genomskinliga detaljer
- FI Läpinäkyvät osat
- RU Прозрачные детали
- PL Przejroczyste części
- CZ Průhledné díly
- HU Átlátszó alkatrészek
- SK Číre diely
- NO Piese transparente
- BG Прозрачни части
- SI Prozorni deli
- GR Διαφανή
- TR Şeffaf parçalar



- DE Abziehbild in Wasser einweichen und anbringen.
- FR Soak and apply decals.
- FR Mouiller et appliquer les décalcomanies.
- NL Transfer in water even laten weken en aanbrengen.
- IT Immergere la decalcomania nell'acqua e applicarla.
- ES Mojar y aplicar calcomanías.
- PT Amolecer o decalque em água e aplicar.
- DK Gør overføringsbilledet vådt og sæt det på.
- NO Myk opp avtrekkingsbildet i vann og sett på.
- SE Blötlägg dekalen i vatten och sätt på den.
- FI Pehmitä siirtokuvaa vedessä ja siirrä paikalleen.
- RU Опустите переводную картинку в воду и нанесите её.
- PL Namoczyć kalkomanie w wodzie i przykleić.
- CZ Nechte obtisk odmočit ve vodě a přilepte.
- HU Merítse vízbe és helyezze fel a matricát.
- SK Obilackový obrázok namočte do vody a priložte na plochu.
- NO Inmuiați abțibildul în apă și aplicați-l.
- BG Потопете ваденката във вода и я поставете.
- SI Prelepnico namakajte v vodi. In namestito
- GR Μουσκεψτε σε νερό και τοποθετήστε τις χαλκομανίες.
- TR Çikartmayı suda yumuşatın ve takın.



- DE Zur Anbringung der Abziehbilder empfohlen.
- FR Recommended for affixing the decals.
- FR Recommandé pour l'application des décalcomanies.
- NL Aanbevolen voor het aanbrengen van de transfers.
- IT Raccomandato per l'applicazione delle decalcomanie.
- ES Recomendado para fijar bien las calcomanías.
- PT Recomendado para a fixação dos autocolantes.
- DK Anbefales til anbringelse af overføringsbillederne.
- NO Anbefales til å feste avtrekksbilder.
- SE Rekommenderad för montering av klisterdekalerna.
- FI Suositellaan siirtokuvien siirtämiseen.
- RU Рекомендуются для нанесения переводных картинок.
- PL Zalecane do przyklejenia kalkomanii.
- CZ Doporučujeme k umístění obtiskovacích obrázků.
- HU A matrica felhelyezéséhez ajánlható.
- SK Odporúčajú sa pre umiestnenie obilackového obrázku.
- NO Recomandat pentru aplicarea abțibildurilor.
- BG Препоръчва се за поставяне на ваденки.
- SI Pri nameštanju nalepnic priporočamo.
- GR Συνιστάται για την τοποθέτηση των χαλκομανιών.
- TR Çikartmaların takılması için önerilir.



- DE Zur Anbringung der Klarteile empfohlen.
- FR Recommended to fix clear parts.
- FR Recommandé pour fixer les pièces transparentes.
- NL Aanbevolen voor het aanbrengen van transparante delen.
- IT Raccomandato per l'applicazione delle parti trasparenti.
- ES Recomendado para fijar las piezas transparentes.
- PT Recomendado para a aplicação das peças transparentes.
- DK Anbefales til anbringelse af de klare dele.
- NO Anbefales til å feste klare deler.
- SE Rekommenderad för montering av de genomskinliga detaljerna.
- FI Suositellaan läpinäkyvien osien siirtämiseen.
- RU Рекомендуются для крепления прозрачных деталей.
- PL Zalecane do przyklejenia przejroczystych części.
- CZ Doporučujeme k umístění průhledných dílů.
- HU Az átlátszó darabok felhelyezéséhez ajánlható.
- SK Odporúčajú sa pre umiestnenie čírych dielov.
- NO Recomandat pentru aplicarea pieselor transparente.
- BG Препоръчва се за поставяне на прозрачни части.
- SI Pri nameštanju prozornih delov priporočamo.
- GR Συνιστάται για την τοποθέτηση των διαφανών μερών.
- TR Şeffaf parçaların takılması için önerilir.

- * DE Nicht enthalten
- FR Not included
- FR Non fourni
- NL Behoort niet tot de levering
- IT Non incluso
- ES No incluido
- PT Não incluído
- DK Medfølger ikke
- NO Ikke inkludert
- SE Ingår ej
- FI Ei sisällä
- RU Не содержится
- PL Nie wchodzi w zakres dostawy
- CZ Není obsaženo
- HU Nem tartalmazza
- SK Neobsahuje
- NO Nu este inclus
- BG Не се включва в комплекта
- SI Ni priloženo
- GR Δεν περιλαμβάνεται
- TR İçermiyor

Benötigte Farben / Required colours

FR Peintures nécessaires
NL Benodigde kleuren
IT Colori necessari
ES Colores necesarios
PT Cores necessárias
DK Nødvendige farver
NO Nødvendige farger
SE Erforderliga färger
FI Tarvittavat värit
RU Необходимые краски
PL Potrzebne kolory
CZ Potřebné barvy
HU Szükséges színek
SK Požadované farby
RO Culori necesare
BG Необходими цветове
SI Potrebne barve
GR Απαιτούμενα χρώματα
TR Gerekli renkler

371

A

DE Hellgrau seidenmatt
GB Light grey silk matt
FR Gris clair satiné mat
NL Lichtgrijs zijdemat
IT Grigio chiaro opaco satinato
ES Gris claro mate satinado
PT Cinza claro mate sedoso
DK Lysegrå silkematt
NO Lysgrå silkematt
SE Ljusgrå sidenmatt
FI Vaaleanharmaa silkkimatta
RU Светло-серый шелковисто-матовый
PL Jasnoszary jedwabiscie matowy
CZ Světlá šedá jemně matný
HU Világosszürke, fakóselymes
SK Svetlo sivá hodvábne matný
RO Gri-deschis satinat
BG Светлосиво коприненоматово
SI Svetlo-siva svilenlo-mat
GR Γκρι ανοιχτό σατίβέ
TR Açık gri ipeksi mat

76

B

DE Hellgrau matt
GB Light grey matt
FR Gris moyen mat
NL Lichtgrijs mat
IT Grigio chiaro opaco
ES Gris claro mate
PT Cinza claro mate
DK Lysegrå mat
NO Lysgrå matt
SE Ljusgrå matt
FI Vaaleanharmaa matta
RU Светло-серый матовый
PL Jasnoszary matowy
CZ Světlá šedivá matný
HU Világosszürke, fénytelen
SK Svetlo sivá matný
RO Gri-deschis mat
BG Светлосиво матово
SI Svetlo-siva mat
GR Γκρι ανοιχτό ματ
TR Açık gri mat

43

C

DE Mittelgrau matt
GB Medium grey matt
FR Gris moyen mat
NL Mediumgrijs mat
IT Grigio medio opaco
ES Gris medio mate
PT Cinzento médio mate
DK Mellemgrå mat
NO Medium grå matt
SE Mellangrå matt
FI Keskiharmmaa matta
RU Средний серый матовый
PL Szary błękitny matowy
CZ Středně šedá matný
HU Középszürke, fénytelen
SK Stredne sivá matný
RO Gri mediu mat
BG Средносиво матово
SI Srednje-siva mat
GR Γκρι μεσαίο ματ
TR Gri mat

50%

36

D

37

50%

DE Karminrot matt
GB Carmine red matt
FR Rouge carmin mat
NL Karmijnrood mat
IT Rosso carminio opaco
ES Rojo carmin mate
PT Vermelho carmin mate
DK Karminrød mat
NO Karminrød matt
SE Karminröd matt
FI Karminipunainen matta
RU Карминный матовый
PL Karminowa czerwień matowy
CZ Karminová červená matný
HU Karminpiros, fénytelen
SK Karminovo červená matný
RO Roșu-carmin mat
BG Карминовочервено матово
SI Karminsko-rdeča mat
GR Άλικο κόκκινο ματ
TR Karmen kırmizisi mat

+

DE Ziegelrot matt
GB Brick red matt
FR Rouge brique mat
NL Terracotta mat
IT Rosso mattone opaco
ES Marrón rojizo mate
PT Castanho tijolo mate
DK Rødbrun mat
NO Teglrød matt
SE Rödbrun matt
FI Tiilenpunainen matta
RU Кирпично-красный матовый
PL Ceglasta czerwień matowy
CZ Červenohnědá matný
HU Téglavörös, fénytelen
SK Červenohnedá matný
RO Roșu cărămiziu mat
BG Керемиденочервено матово
SI Opečno-rdeča mat
GR Καφέ κοκκινωπό ματ
TR Kizil kahve mat

06

E

DE Teerschwarz matt
GB Tar black matt
FR Noir goudron mat
NL Teerzwart mat
IT Nero catrame opaco
ES Negro brea mate
PT Preto alcatrão mate
DK Tjæresort mat
NO Tjæresort matt
SE Tjårsvart matt
FI Tervanmusta matta
RU Битумно-чёрный матовый
PL Czarna smoła matowy
CZ Dehtová černá matný
HU Kátrányfekete, fénytelen
SK Čierna térová matný
RO Negru-inchis mat
BG Катранено черно матово
SI Katransko-črna mat
GR Μαύρο βαθύ ματ
TR Katran siyahı mat

90

F

DE Silber metallic
GB Silver metallic
FR Argent métallique
NL Zilver metallic
IT Argento metallico
ES Plata metálico
PT Prata metálico
DK Sølv metallisk
NO Sølv metallisk
SE Silver metallisk
FI Hopea metallinen
RU Серебрянный металл
PL Srebrny metaliczny
CZ Stříbrná metalizovaný
HU Ezüstmetál
SK Strieborná metaliza
RO Argintiu metallic
BG Сребро металик
SI Srebrna kovinska
GR Ασημί μεταλλικό
TR Gümüş rengi metalik

302

G

DE Schwarz seidenmatt
GB Black silk matt
FR Noir satiné mat
NL Zwart zijdemat
IT Nero opaco satinato
ES Negro mate satinado
PT Preto mate sedoso
DK Sort silkematt
NO Sort silkematt
SE Svart sidenmatt
FI Musta silkkimatta
RU Чёрный шелковисто-матовый
PL Czarny jedwabiscie matowy
CZ Černá jemně matný
HU Fekete, fakóselymes
SK Čierna hodvábne matný
RO Negru satinat
BG Черно коприненоматово
SI Črna svilenlo-mat
GR Μαύρο σατίβέ
TR Siyah ipeksi mat

88

H

DE Ocker matt
GB Ochre matt
FR Ocre mat
NL Oker mat
IT Ocra opaco
ES Ocre mate
PT Ocre mate
DK Okkerbrun mat
NO Okkerbrun matt
SE Okkrabrun matt
FI Okranruskea matta
RU Охра матовый
PL Ochra matowy
CZ Okr hnědý matný
HU Okker, fénytelen
SK Okrová matný
RO Ocru mat
BG Охра матово
SI Oker mat
GR Όχρα ματ
TR Toprak rengi mat

301

I

DE Weiß seidenmatt
GB White silk matt
FR Blanc satiné mat
NL Wit zijdemat
IT Bianco opaco satinato
ES Blanco mate satinado
PT Branco mate sedoso
DK Hvid silkematt
NO Hvit silkematt
SE Vit sidenmatt
FI Valkoinen silkkimatta
RU Белый шелковисто-матовый
PL Biały jedwabiscie matowy
CZ Bílá jemně matný
HU Fehér, fakóselymes
SK Biela hodvábne matný
RO Alb satinat
BG Бяло коприненоматово
SI Bela svilenlo-mat
GR Άπρο σατίβέ
TR Beyaz ipeksi mat

35

J

DE Hautfarbe matt
GB Flesh matt
FR Couleur chair mat
NL Huidkleur mat
IT Color pelle opaco
ES Carne mate
PT Cor da pele mate
DK Hudfarvet mat
NO Hudfarge matt
SE Hudfärg matt
FI Ihonväri matta
RU Телесный матовый
PL Cielisty matowy
CZ Kůže matný
HU Bőrszínű, fénytelen
SK Pletťová matný
RO Culoarea pielii mat
BG Телесен цвят матово
SI Kožne-barve mat
GR Χρώμα δέρματος ματ
TR Ten rengi mat

56

K

DE Blau matt
 GB Blue matt
 FR Bleu mat
 NL Blauw mat
 IT Blu opaco
 ES Azul mate
 PT Azul mate
 DK Blå mat
 NO Blå matt
 SE Blå matt
 FI Sininen matta
 RU Синий матовый
 PL Niebieski matowy
 CZ Modrá matný
 HU Kék, fénytelen
 SK Modrá matný
 RO Albastru mat
 BG Синьо матово
 SI Modra mat
 GR Μπλε ματ
 TR Mavi mat

314

L

DE Beige seidenmatt
 GB Beige silk matt
 FR Beige satiné mat
 NL Beige zijdemat
 IT Beige opaco satinato
 ES Beige mate satinado
 PT Beige mate sedoso
 DK Beige silkematt
 NO Beige silkematt
 SE Beige sidenmatt
 FI Beige silkkimatta
 RU Бежевый шелковисто-матовый
 PL Beżowy jedwabście matowy
 CZ Běžová jemně matný
 HU Bézs, fakóselymes
 SK Běžová hodvábné matný
 RO Bej satinat
 BG Бежово коприненоматово
 SI Bež svileni mat
 GR Μπεζ σατινέ
 TR Bej ipeksi mat

01

M

DE Farblos glänzend
 GB Clear gloss
 FR Incolore brillant
 NL Kleurloos glanzend
 IT Incolore lucido
 ES Incolore brillante
 PT Verniz brilhante
 DK Klarlak blank
 NO Klar glansende
 SE Klarlack blank
 FI Värítön kiiltävä
 RU Бесцветный глянецовый
 PL Przejroczysty błyszczący
 CZ Bezbarvá lesklý
 HU Színtelen, fényes
 SK Priehľadný lesklý
 RO Transparent strălucitor
 BG Безцветно гланцово
 SI Brezbarvna sijoca
 GR Διάφανο γυαλιστερό
 TR Rensiz parlak

02

N

DE Farblos matt
 GB Clear matt
 FR Incolore mat
 NL Kleurloos mat
 IT Incolore opaco
 ES Incolore mate
 PT Verniz mate
 DK Klarlak mat
 NO Klar matt
 SE Klarlack matt
 FI Värítön matta
 RU Бесцветный матовый
 PL Przejroczysty matowy
 CZ Bezbarvá matný
 HU Színtelen, fénytelen
 SK Priehľadný matný
 RO Transparent mat
 BG Безцветно матово
 SI Brezbarvna mat
 GR Διάφανο ματ
 TR Rensiz mat

50

O

DE Lichtblau glänzend
 GB Light blue gloss
 FR Bleu clair brillant
 NL Lichtblauw glanzend
 IT Blu luce lucido
 ES Azul claro brillante
 PT Azul claro brilhante
 DK Lyseblå blank
 NO Lyseblå glansende
 SE Lysande blå blank
 FI Vaaleansininen kiiltävä
 RU Светло-синий глянецовый
 PL Rozświetlony niebieski błyszczący
 CZ Světlá modrá lesklý
 HU Halványkék, fényes
 SK Svetlo modrá lesklý
 RO Albastru-deschis strălucitor
 BG Лъчистосиньо гланцово
 SI Svetlo-modra sijoca
 GR Μπλε ανοιχτό γυαλιστερό
 TR Açık mavi parlak

330

P

DE Feuerrot seidenmatt
 GB Fiery red silk matt
 FR Rouge feu satiné mat
 NL Vuurood zijdemat
 IT Rosso fuoco opaco satinato
 ES Rojo fuego mate satinado
 PT Vermelho fogo mate sedoso
 DK Ildrød silkematt
 NO Ildrød silkematt
 SE Eldröd sidenmatt
 FI Tulenpunainen silkkimatta
 RU Огненно-красный шелковисто-матовый
 PL Ognistoczerwony jedwabście matowy
 CZ Ohnivě červená jemně matný
 HU Tűzpiros, fakóselymes
 SK Ohnivá červená hodvábné matný
 RO Roșu aprins satinat
 BG Огненочервено коприненоматово
 SI Ognjeno-rdeča svileni-mat
 GR Κόκκινο φωτιάς σατινέ
 TR Alev kırmızısı ipeksi mat

15

Q

DE Gelb matt
 GB Yellow matt
 FR Jaune mat
 NL Geel mat
 IT Giallo opaco
 ES Amarillo mate
 PT Amarelo mat
 DK Gul mat
 NO Gul matt
 SE Gul matt
 FI Keltainen matta
 RU Жёлтый матовый
 PL Żółty matowy
 CZ Žlutá matný
 HU Sárga, fénytelen
 SK Žltá matný
 RO Galben mat
 BG Жълто матово
 SI Rumena mat
 GR Κίτρινο ματ
 TR Sarı mat

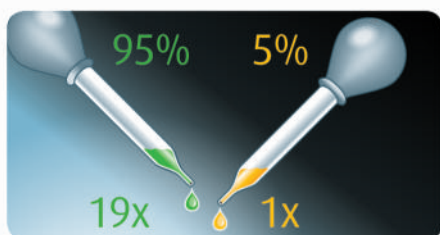

DE Beispiel: mischen
 GB Example: mixing
 FR Exemple: mélanger
 NL Voorbeeld: mengen
 IT Esempio: mescolare
 ES Ejemplo: mezcla
 PT Exemplo: misturar
 DK Eksempel: blanding
 NO Eksempel: blanding
 SE Exempel: blanda
 FI Esimerkki: sekoittaminen
 RU Пример: смешивание
 PL Przykład: mieszać
 CZ Příklad: míchání
 HU Példa: keverés
 SK Příklad: miešanie
 RO Exemplu: amestecare
 BG Пример: смесване
 SI Primer: mešanje
 GR Παράδειγμα: ανάμειξη
 TR Örnek: karıştırma

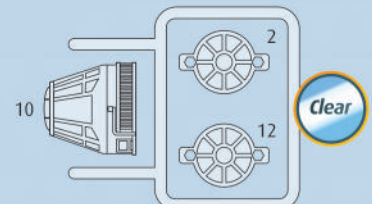
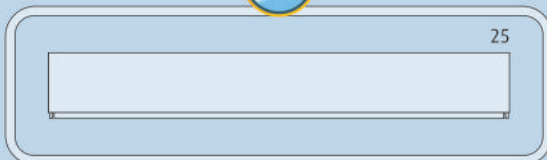
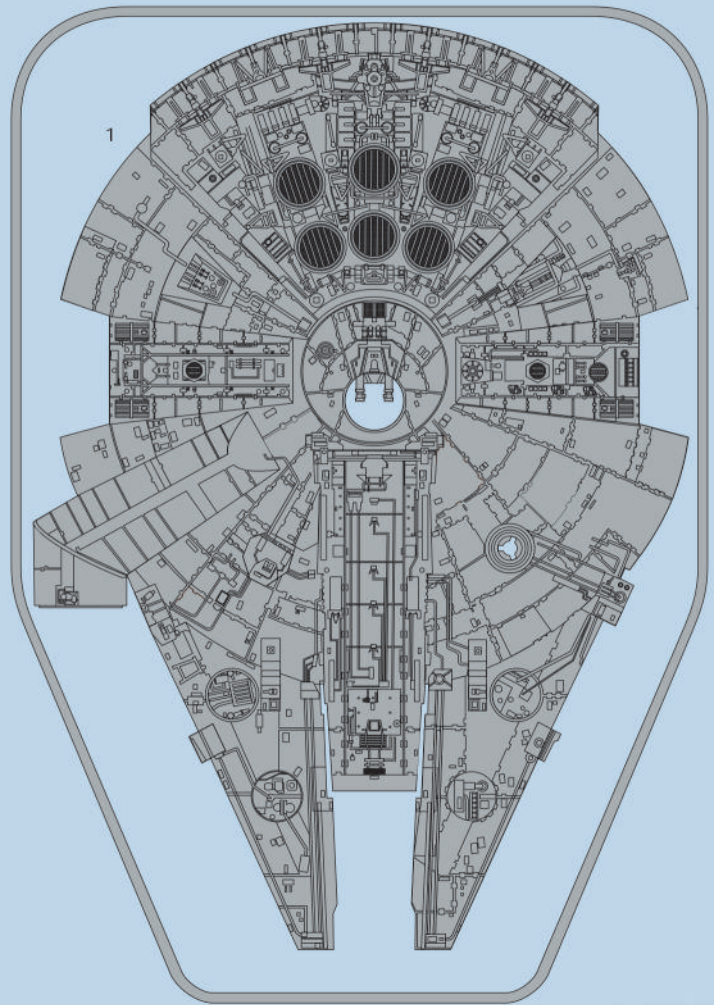
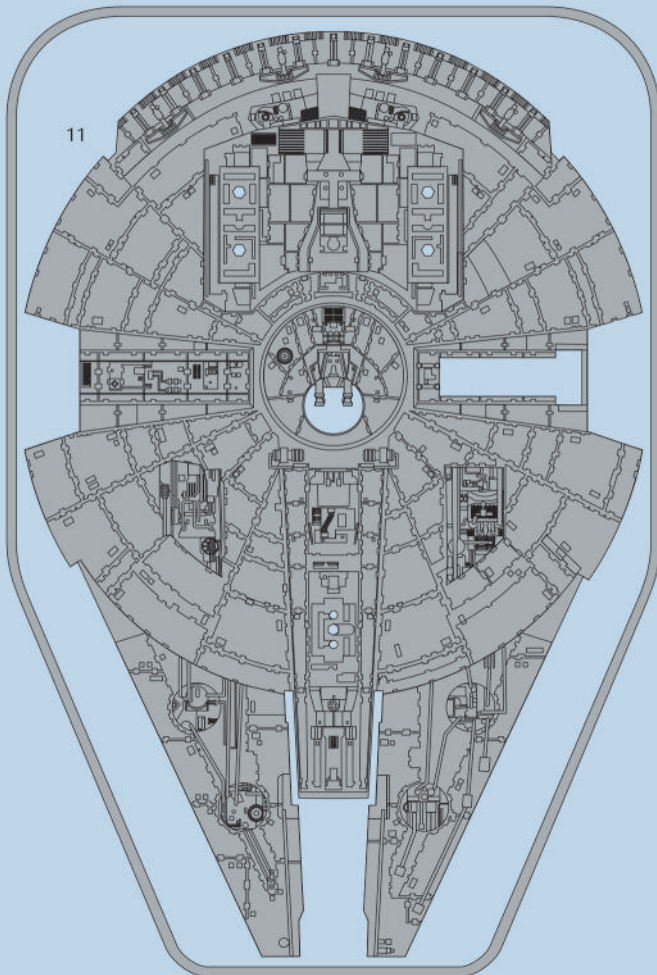

Ersatzteile benötigt?

Kein Problem. Einfach den Revell-Service mit Angabe von Artikel- und Teilenummer kontaktieren. Entweder unter service@revell.de oder Revell GmbH, Abteilung X, Henschelstr. 20-30, 32257 Bünde.*

*Wir bitten um Verständnis, dass eine Gewährleistung nur bei aktuellen Artikeln, die im Zeitraum der letzten 24 Monate erworben wurden, übernommen werden kann. Mit der Ersatzteil-Bestellung können Kosten z.B. für Verpackung und Versand entstehen. Ob diese Kosten anfallen wird im Vorfeld schriftlich durch unseren Service mitgeteilt. Das Angebot kann dann angenommen oder abgelehnt werden. Unfrei eingesandte Ersatzteil-Bestellungen werden von uns nicht angenommen! Dieser Direktservice gilt für die Länder Deutschland, Benelux, Österreich, Frankreich, Großbritannien. Ersatzteil-Bestellungen aus den übrigen Ländern werden über die jeweiligen Distributeure abgewickelt. Bitte kontaktieren Sie Ihren Händler.

Besoin de pièces de rechange ?

Il vous suffit de contacter le service Revell et d'indiquer la référence de l'article et de la pièce. Soit en écrivant par mail à service@revell.de (uniquement pour la France) ou par courrier à Revell GmbH, Département X, Henschelstr. 20-30, D-32257 Bünde.*

*La garantie s'applique pour les articles présents au catalogue et achetés au cours des 24 derniers mois. Merci de votre compréhension. La commande de pièces de rechange peut donner lieu à des frais supplémentaires, par ex. pour l'emballage et le port. Notre service client vous en informera au préalable par écrit. Vous pourrez accepter ou refuser le devis. Nous n'acceptons pas les commandes de pièces de rechange envoyées sans affranchissement ! Ce service direct est valable pour les pays suivants : Allemagne, Benelux, Autriche, France, Grande-Bretagne. Les commandes de pièces de provenance d'autres pays sont traitées par les distributeurs correspondants. Veuillez contacter votre revendeur.

Need spare parts?

No problem. Contact Revell Service with the item number and part numbers you need: service@revell.de or Revell GmbH, Unit 10, Old Airfield Industrial Estate, Cheddington Lane, Tring, Herts, HP23 4QR, Great Britain.*

*We request your understanding that a warranty can only be accepted for current articles which have been purchased in the last 24 months. Orders for spare parts may also be subject to costs for packaging and shipping. You will be notified in advance by our Service department if such costs are incurred. The offer can then be accepted or rejected. We will not be able to process any postal requests unless correct postage has been applied to mailing! This direct service applies to the countries: Germany, Benelux, Austria, France, and the United Kingdom. Spare part orders from other countries are processed by the local distributors. Please contact your dealer.

Hebt u reserveonderdelen nodig?

Geen probleem! Neem eenvoudig contact op met de klantenservice van Revell en geef ons het artikel- en onderdeelnummer door. U kunt ons bereiken op service@revell.de of per post: Revell GmbH, Afdeling X, Henschelstr. 20-30, 32257 Bünde.*

*Wij vragen uw begrip voor de omstandigheid, dat er alleen garantie kan worden geboden voor actuele artikelen, die in de afgelopen 24 maanden zijn gekocht. Met het bestellen van reserveonderdelen kunnen kosten gemoeid zijn, bijv. voor verpakking en verzending. U wordt vooraf schriftelijk door onze klantenservice op de hoogte gesteld als er kosten zouden ontstaan. Het aanbod kan dan worden aangenomen of afgewezen. Wij nemen geen ongefrankeerde bestellingen van reserveonderdelen aan! Deze rechtstreekse service wordt verleend in de landen Duitsland, de Benelux, Oostenrijk, Frankrijk en Groot-Brittannië. Bestellingen van reserveonderdelen in de overige landen worden afgewikkeld via de betreffende distributeurs. Neem hiervoor contact op met uw verkoper.

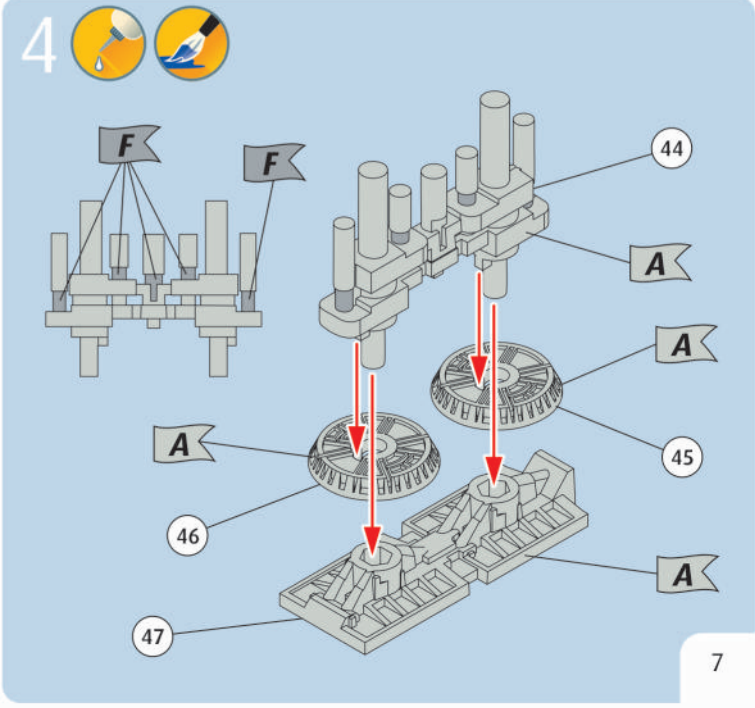
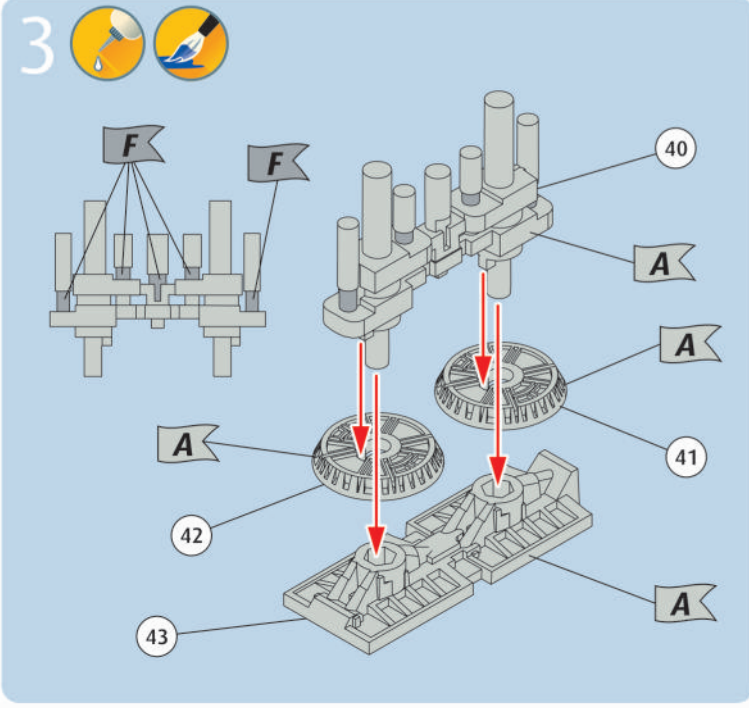
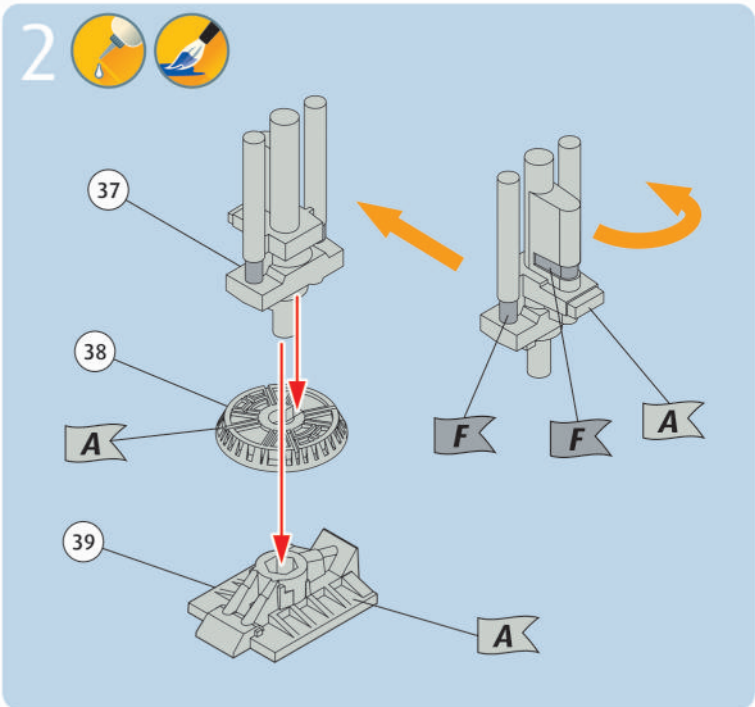
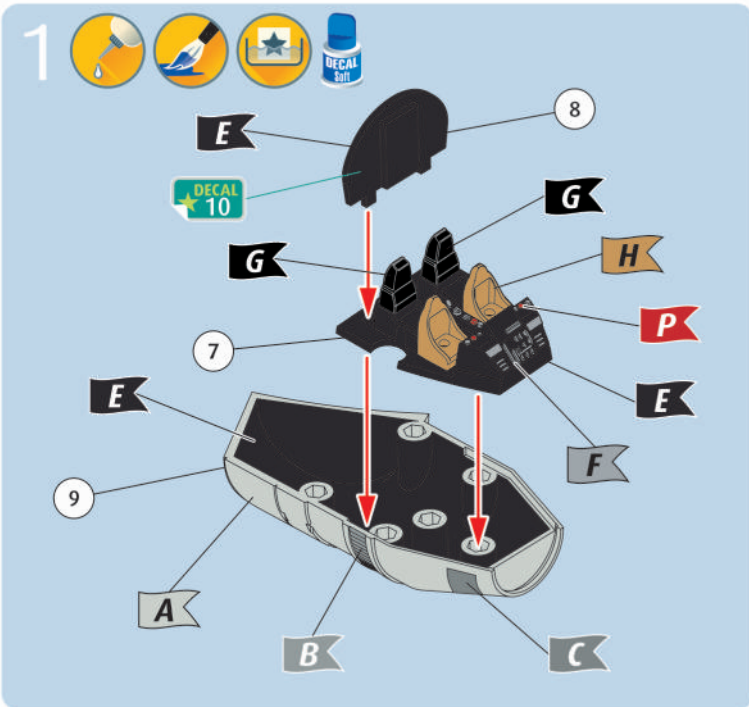
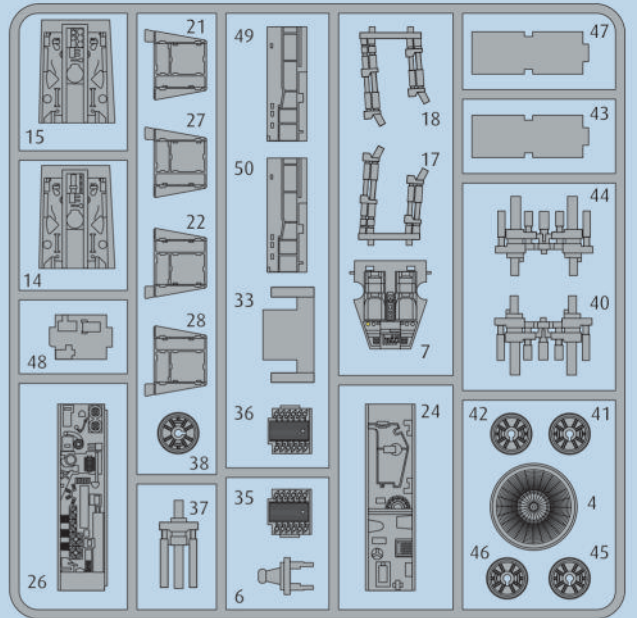
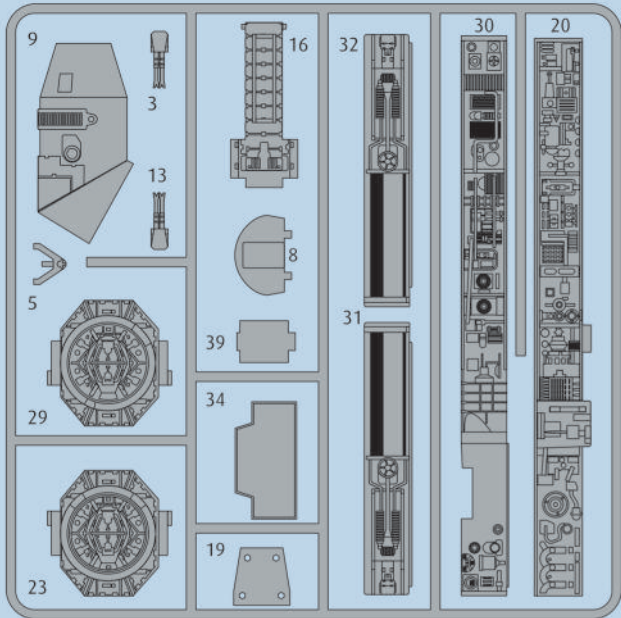



5

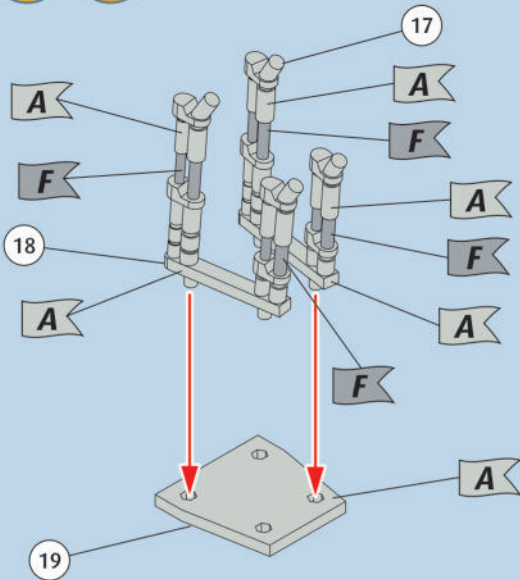

6

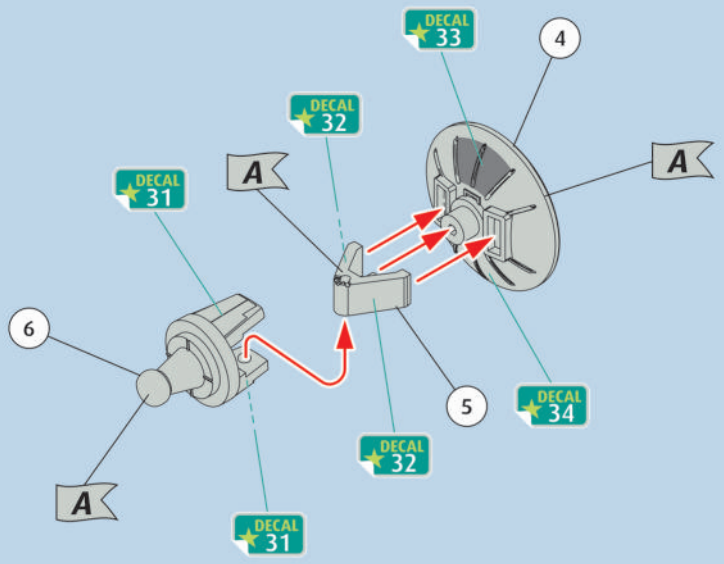

7

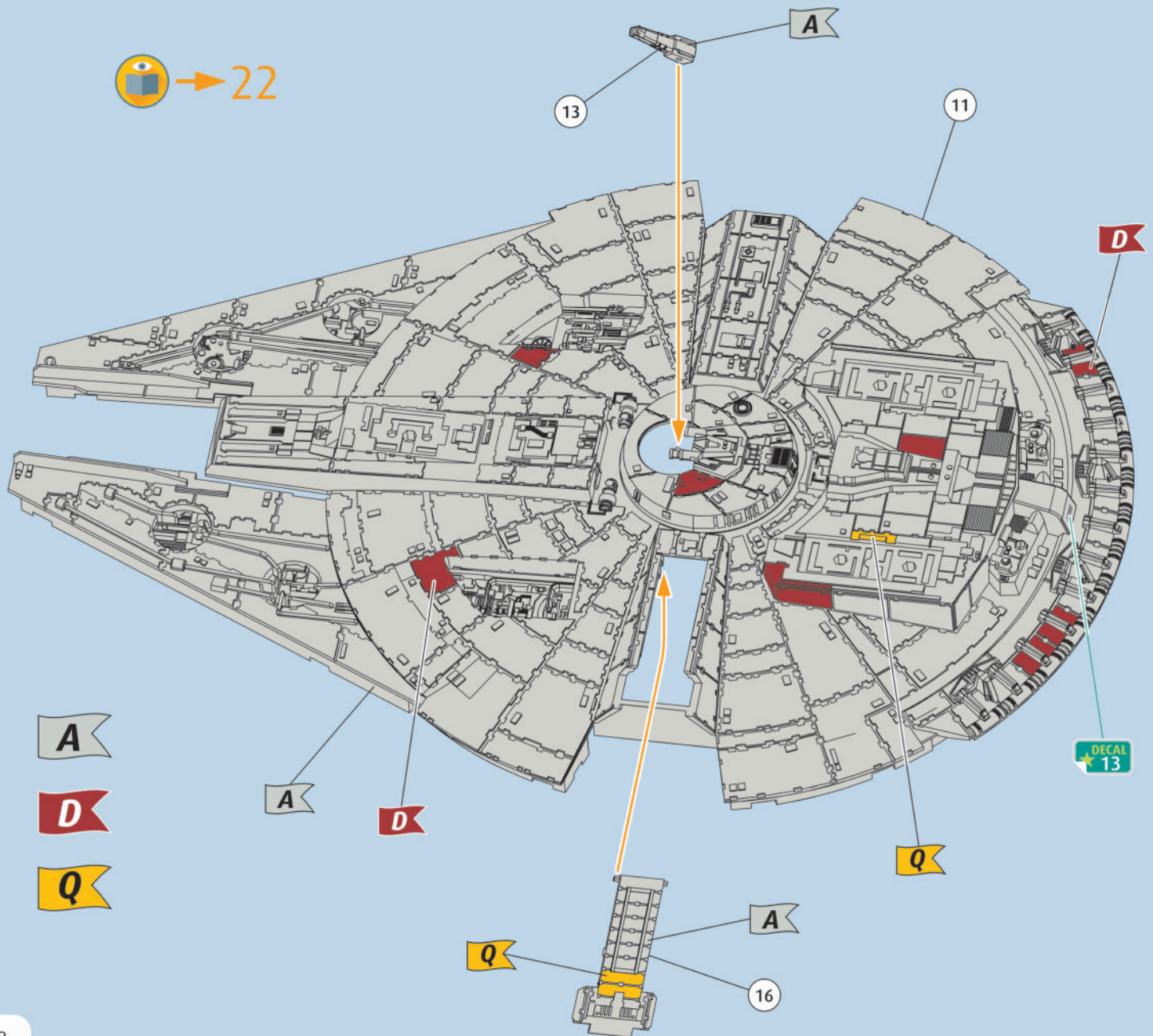
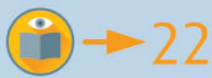

7a 

 → 22

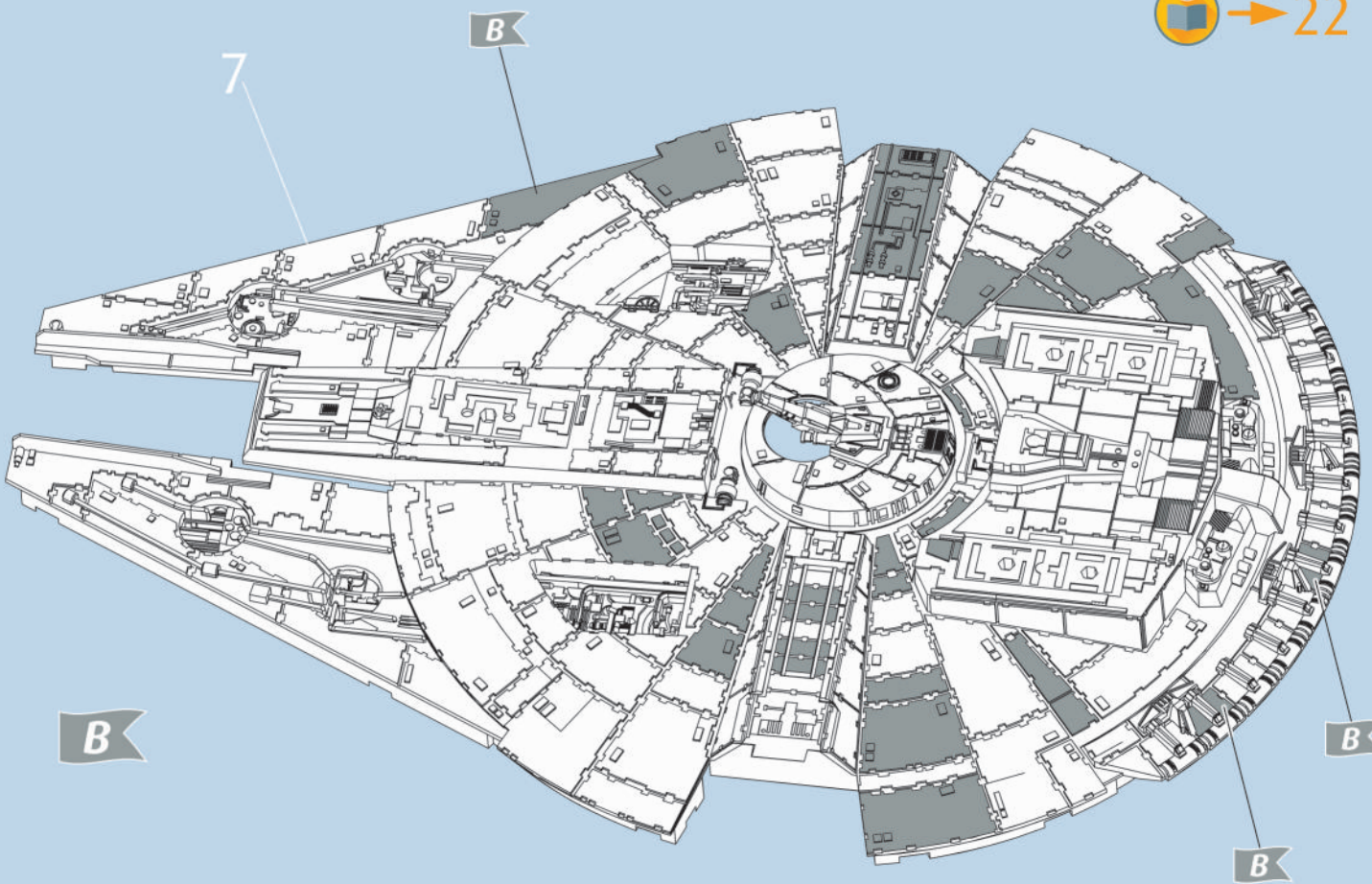

7b 

 → 22

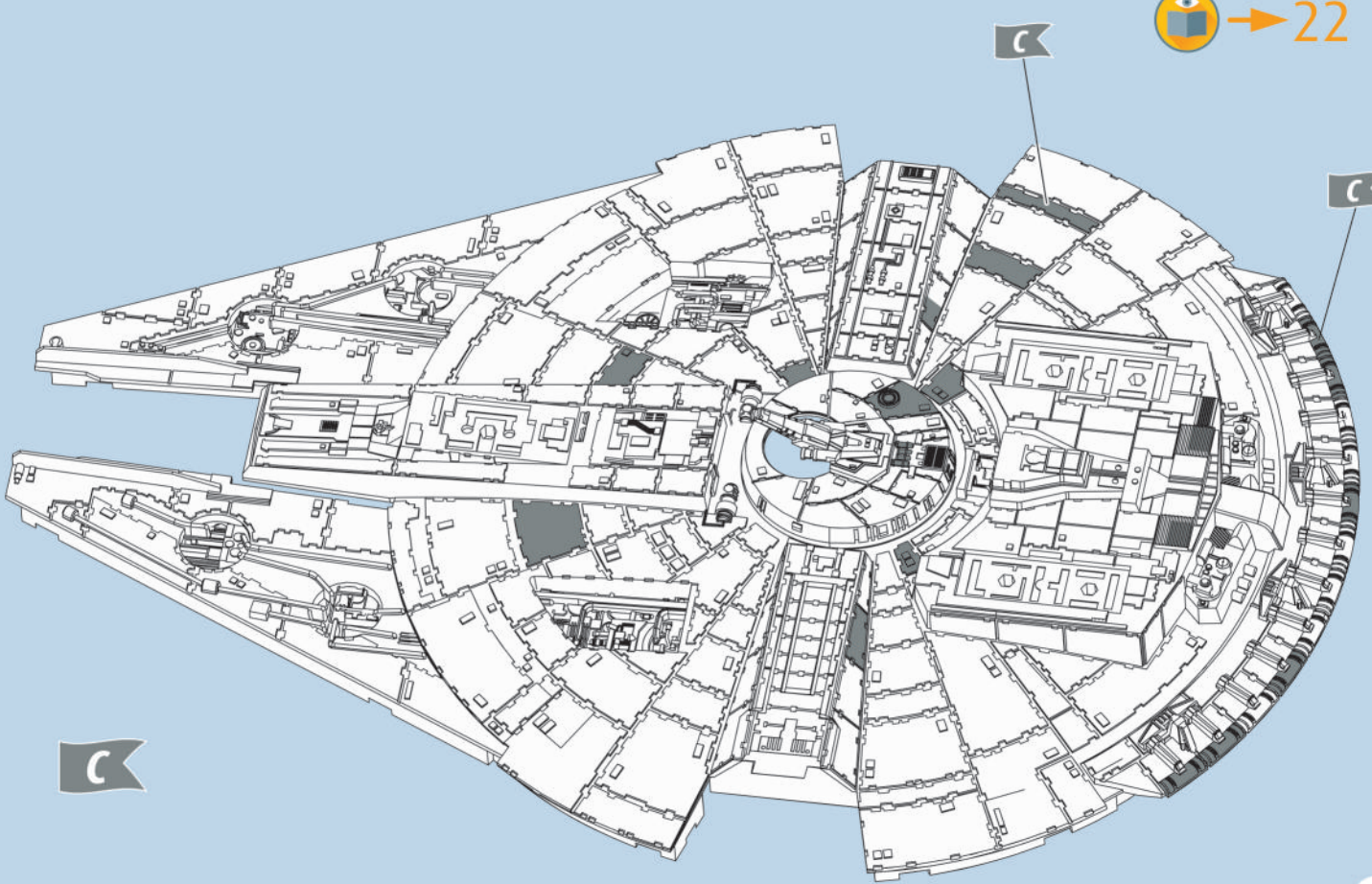

8

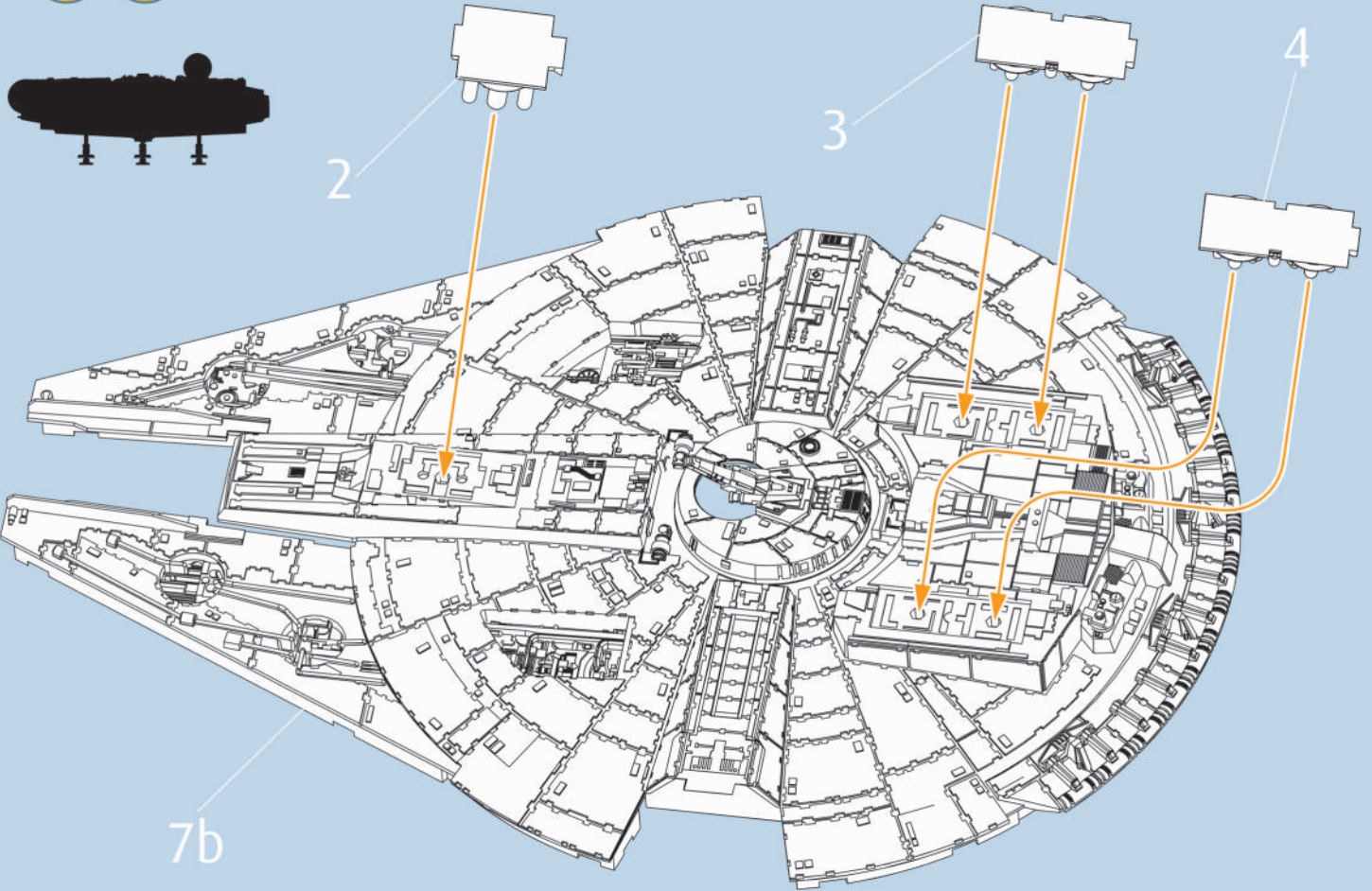

7b

9

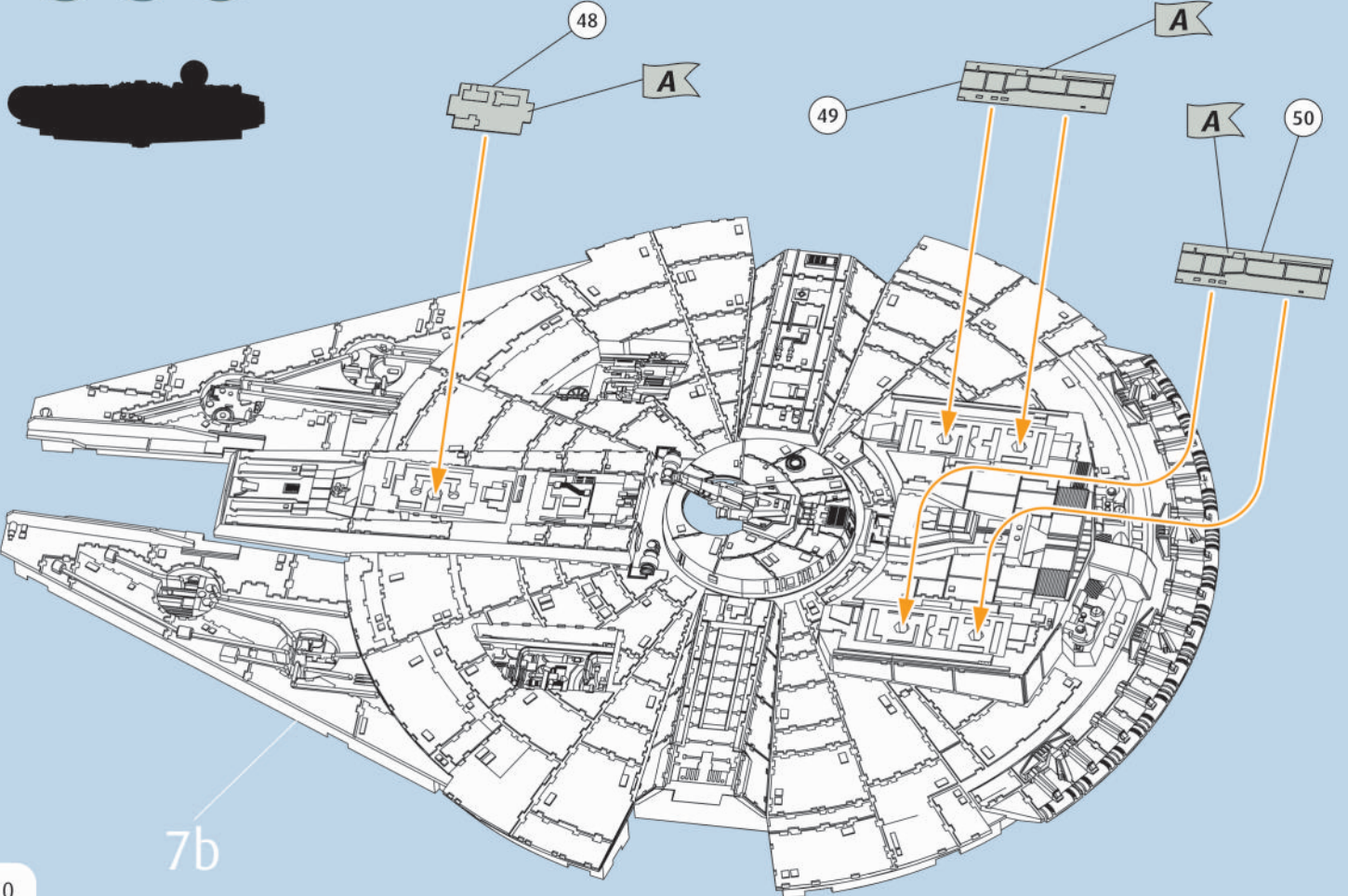

7b

10

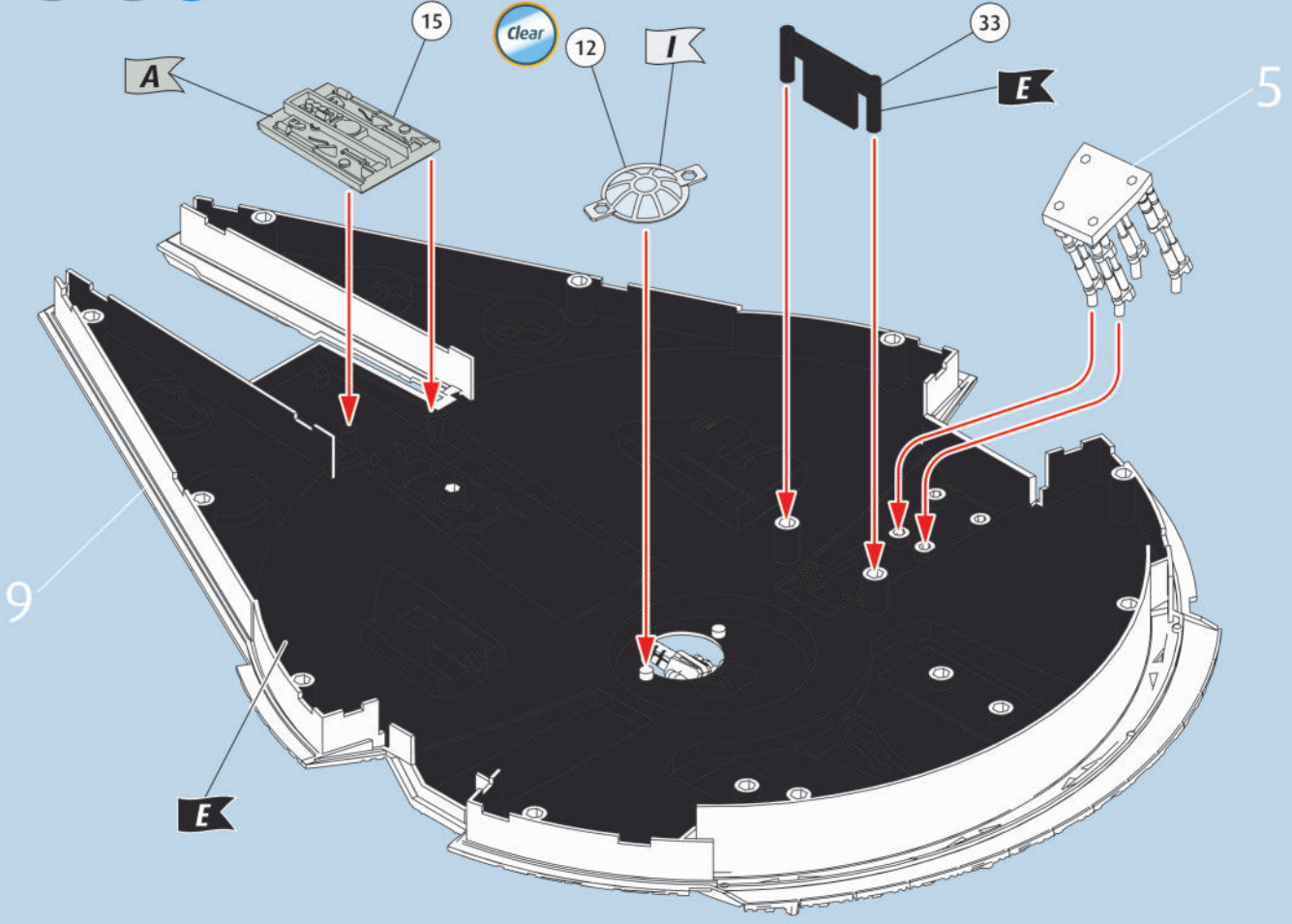

11

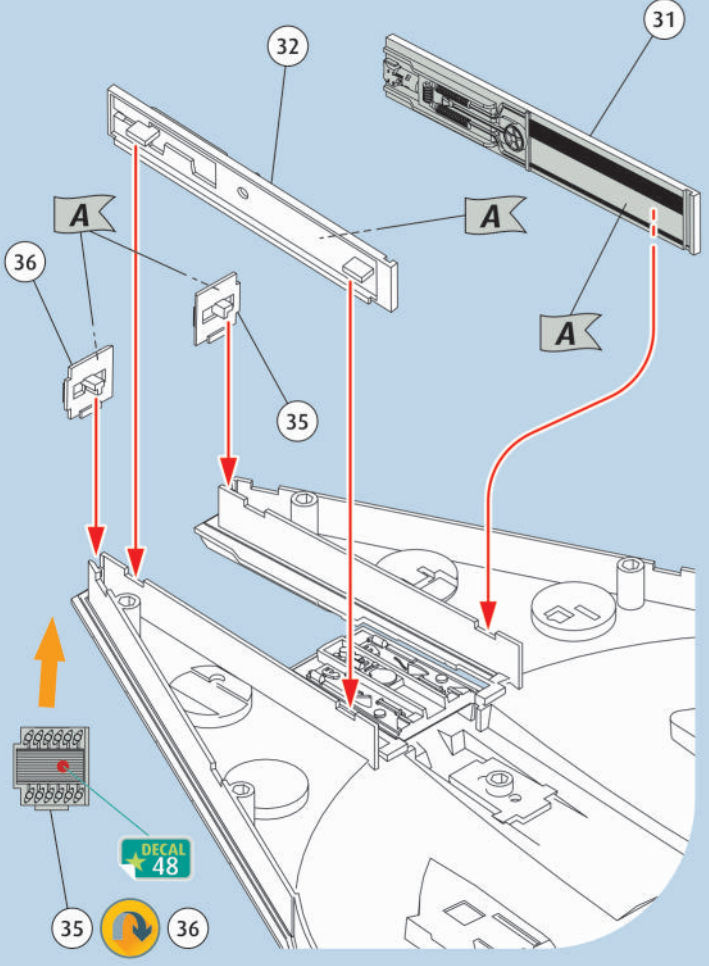

11a

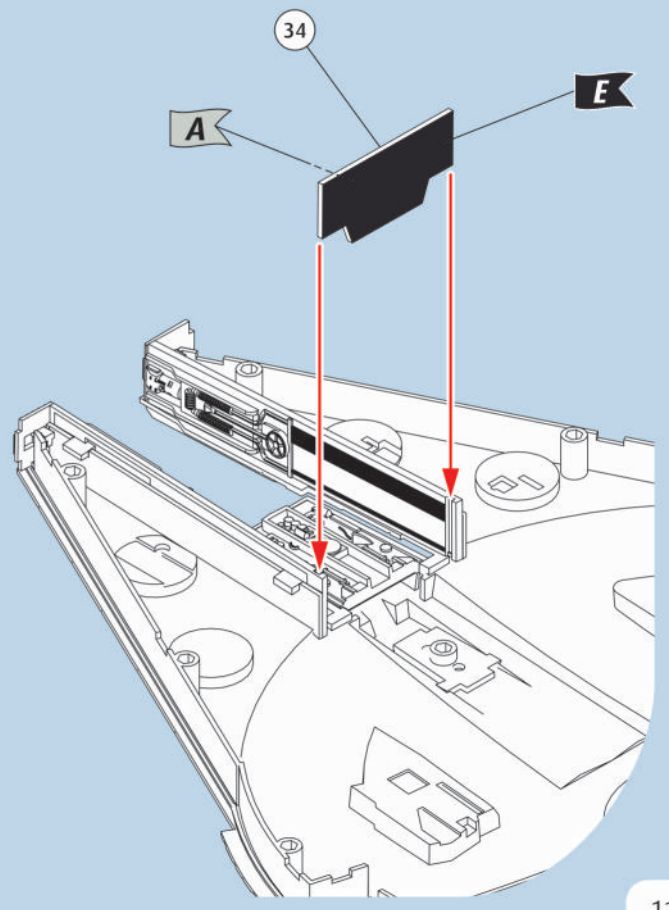

12

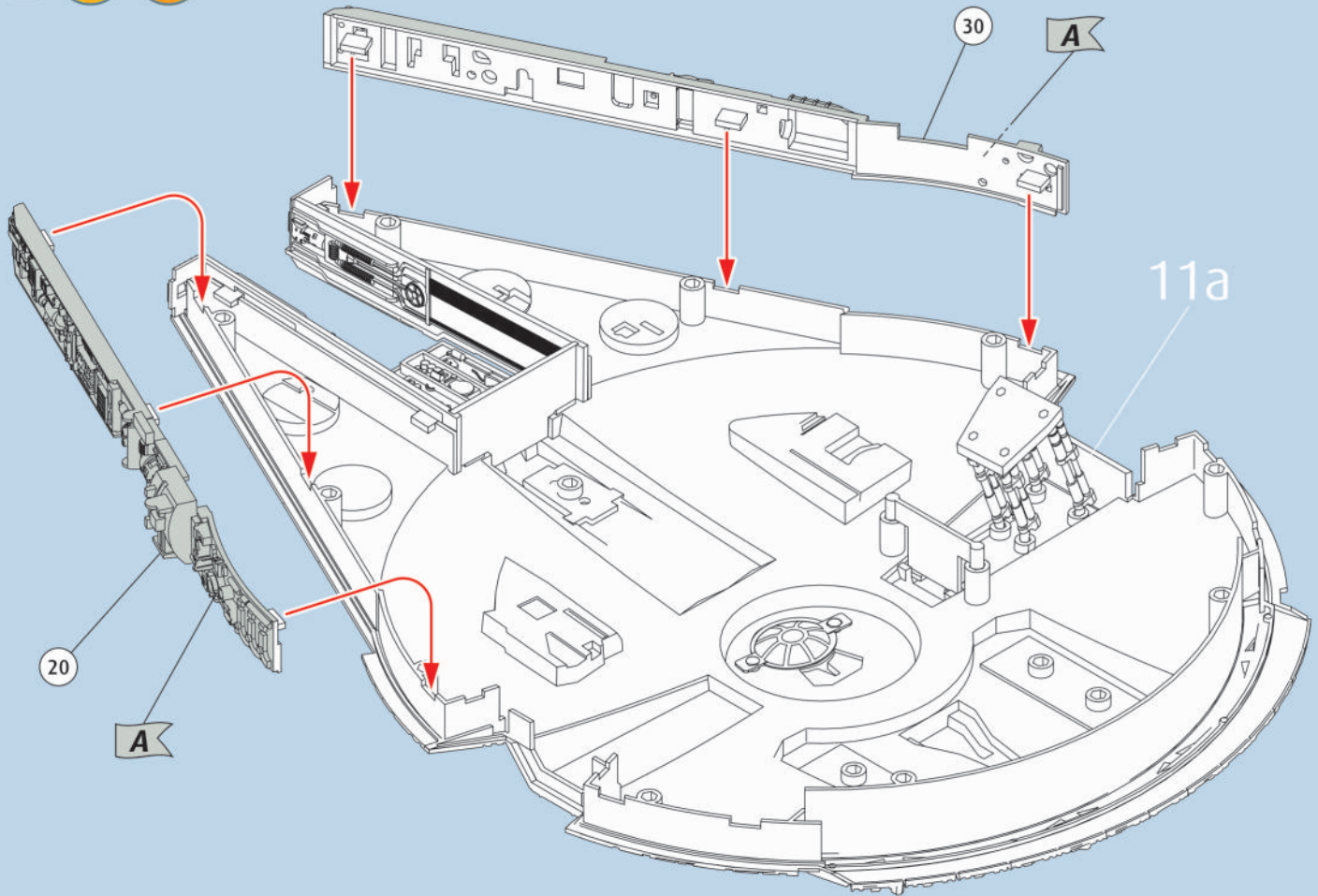

13

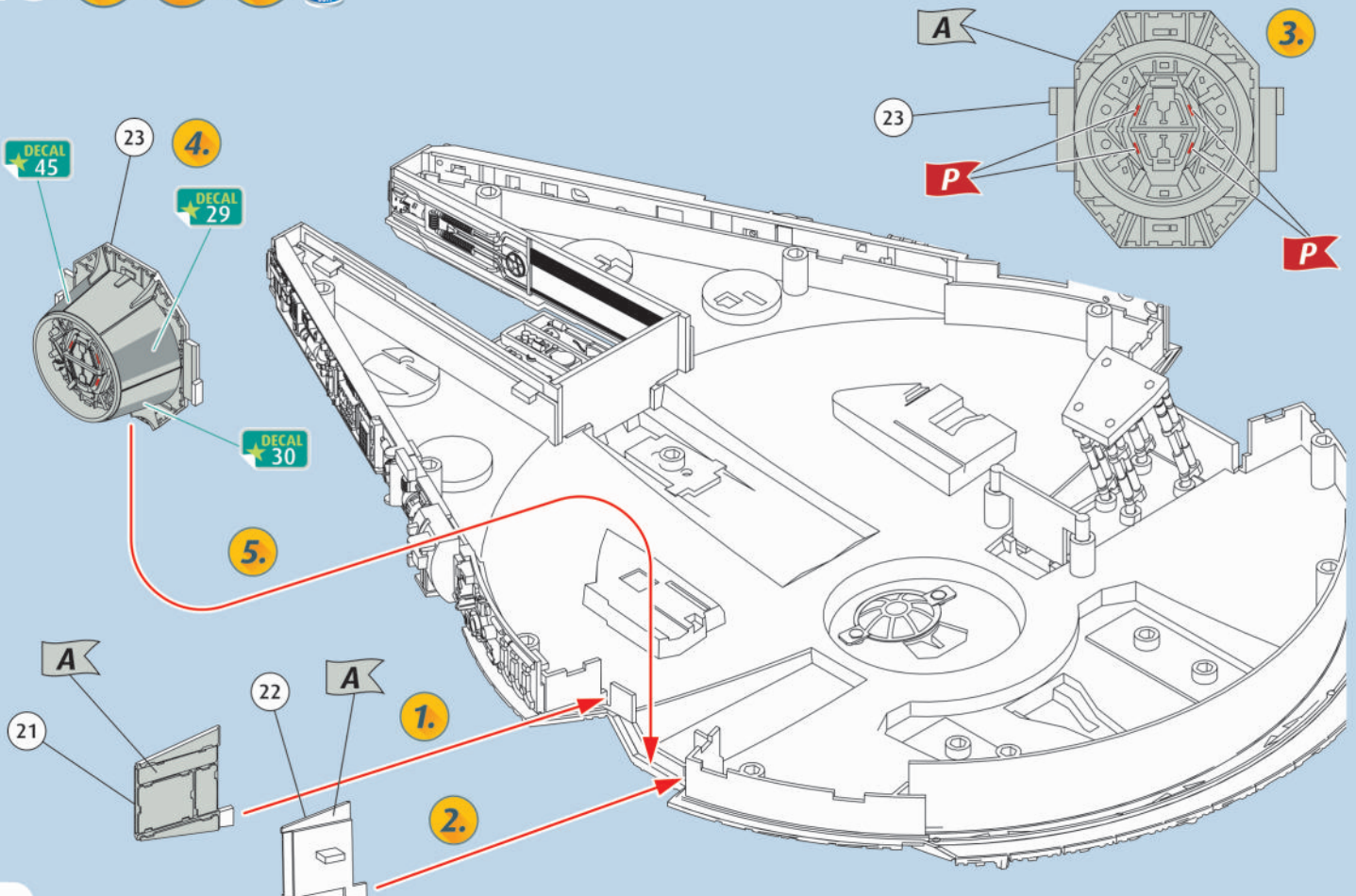

14

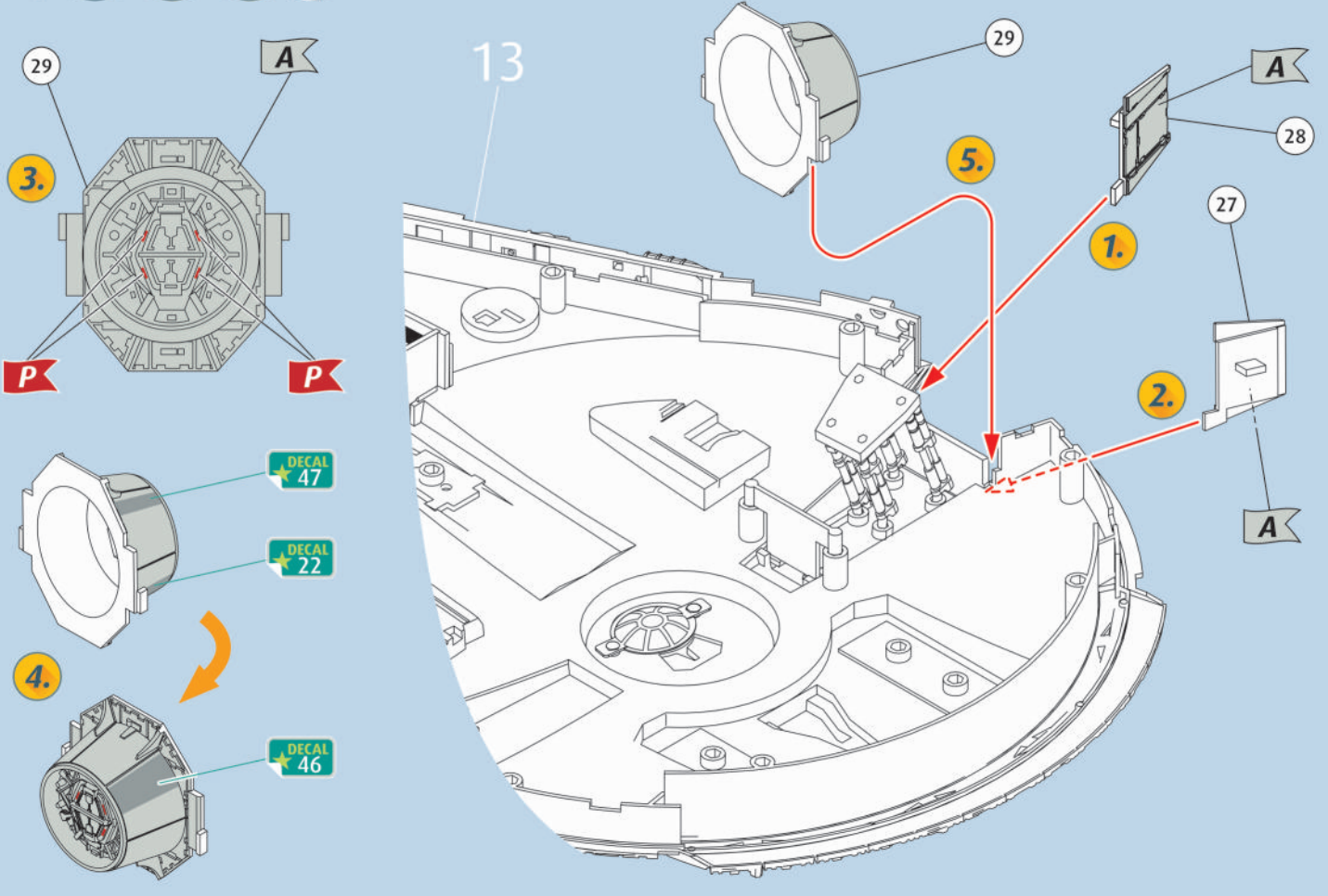

15

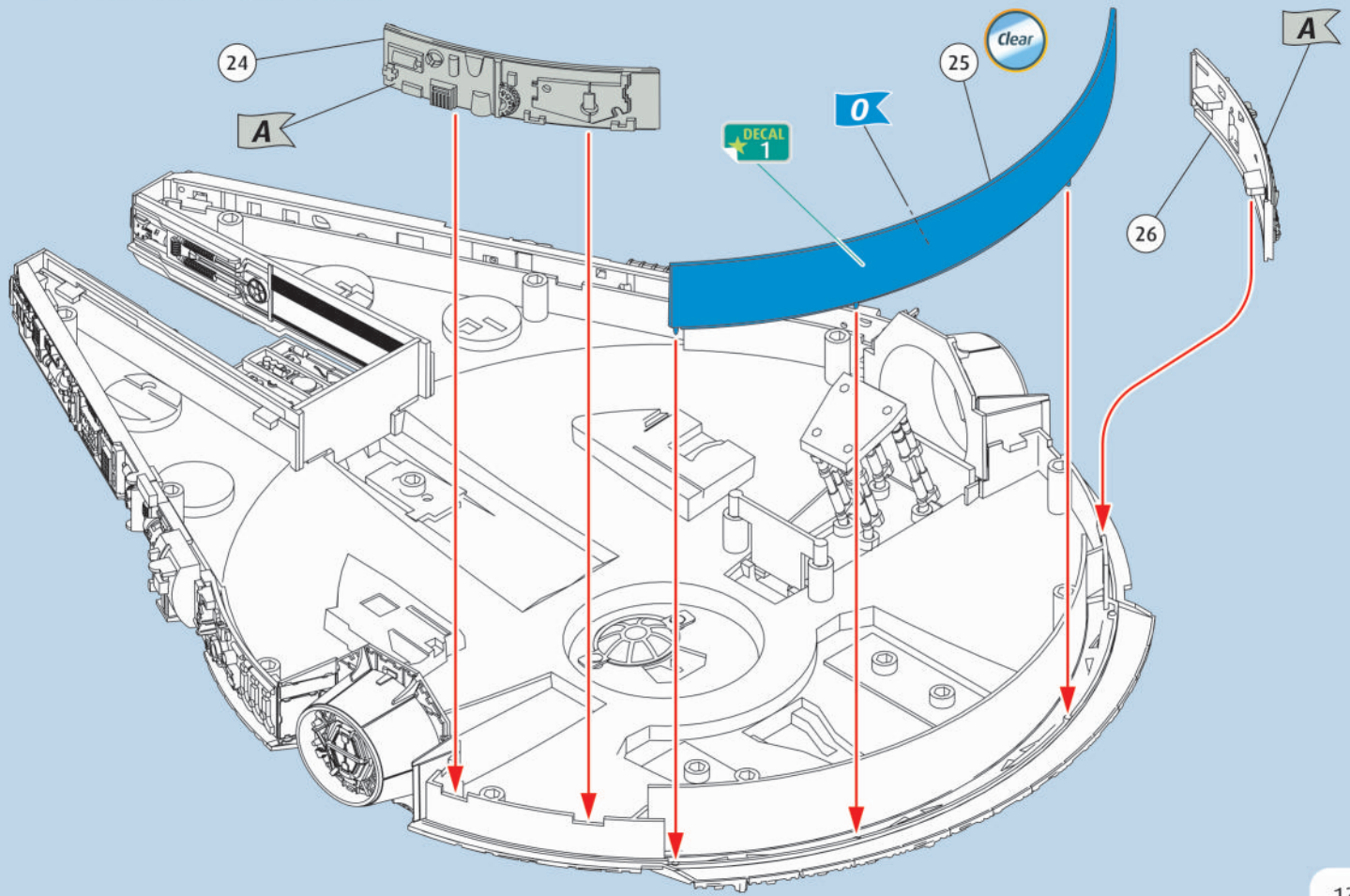

16



→ 21

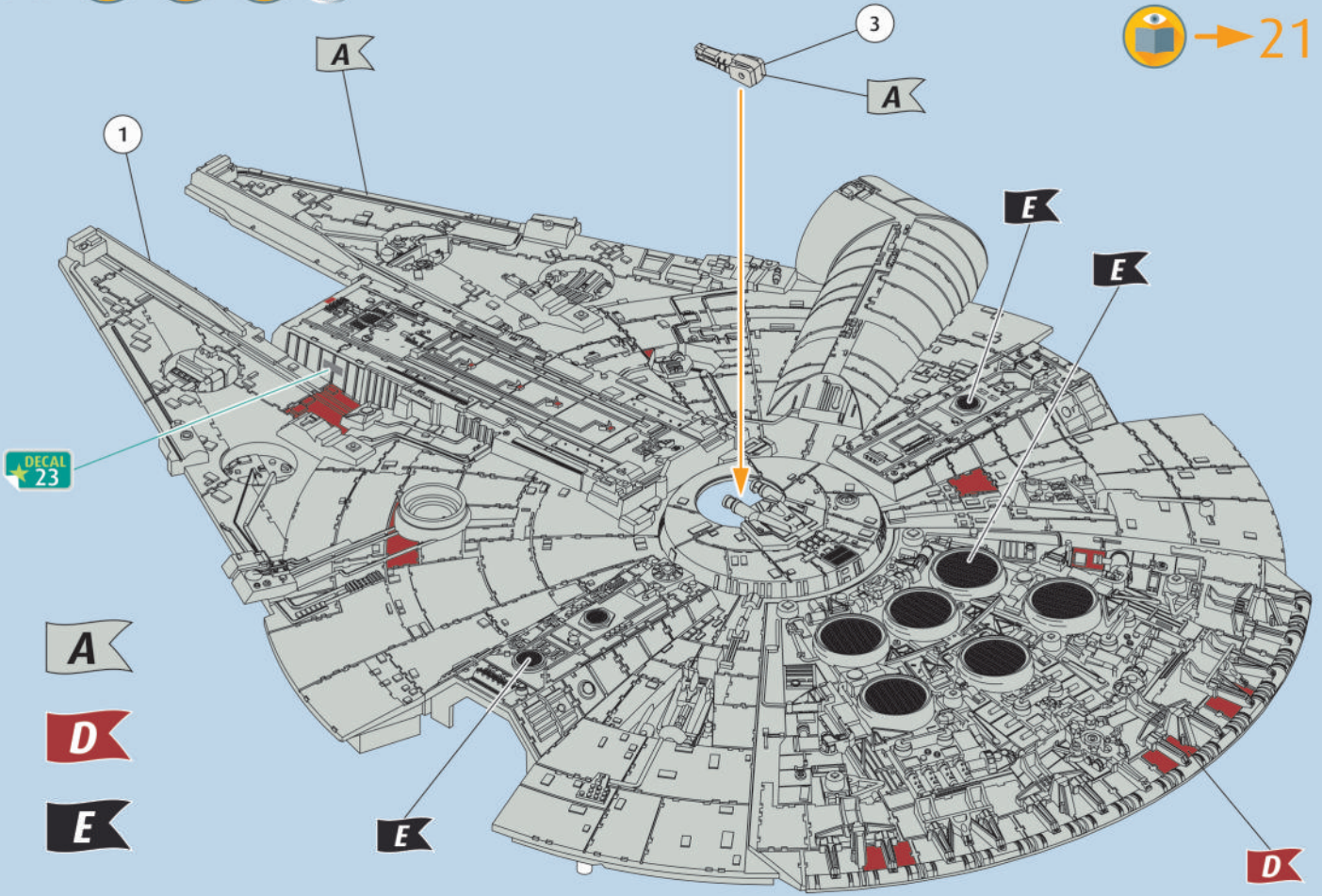

16a



→ 21

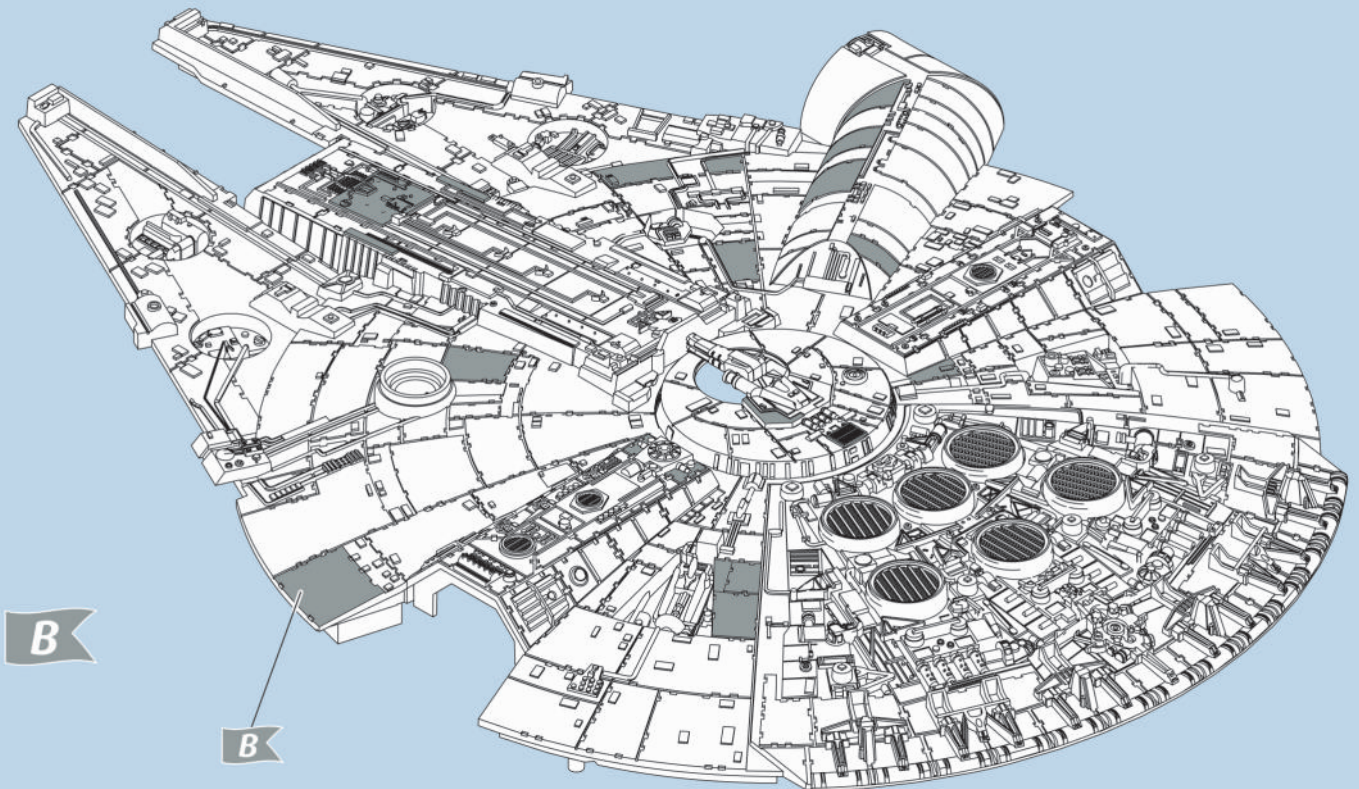

16b

 → 21

16a

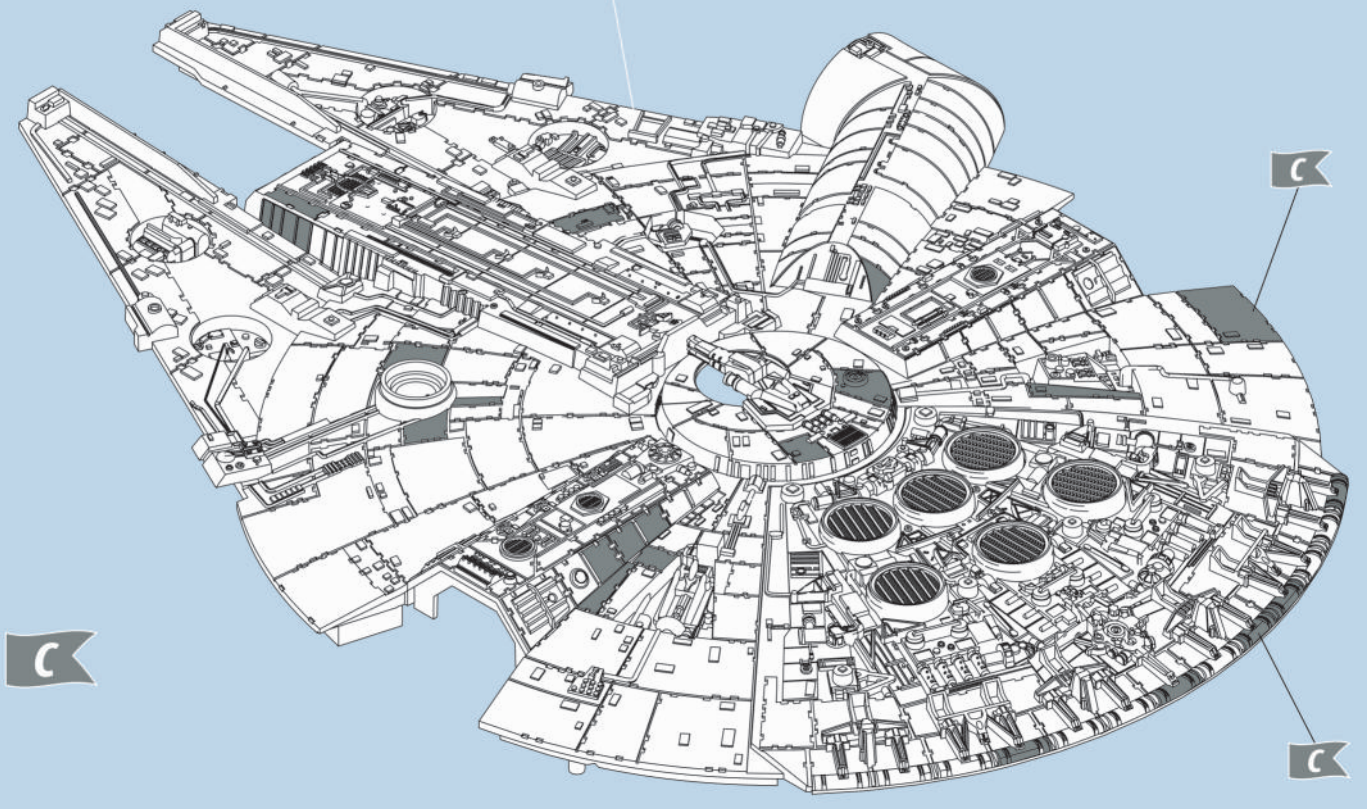

17

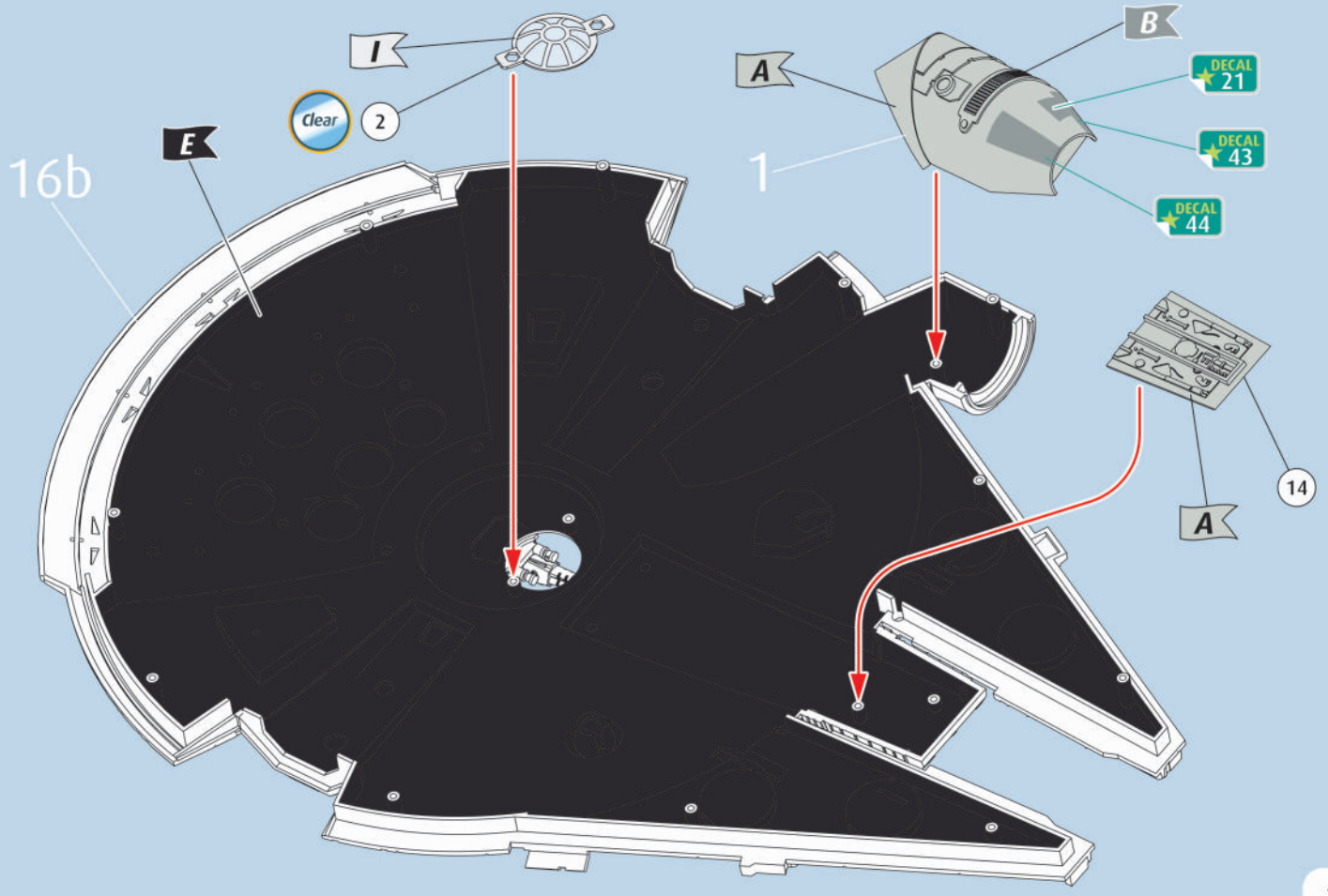

18

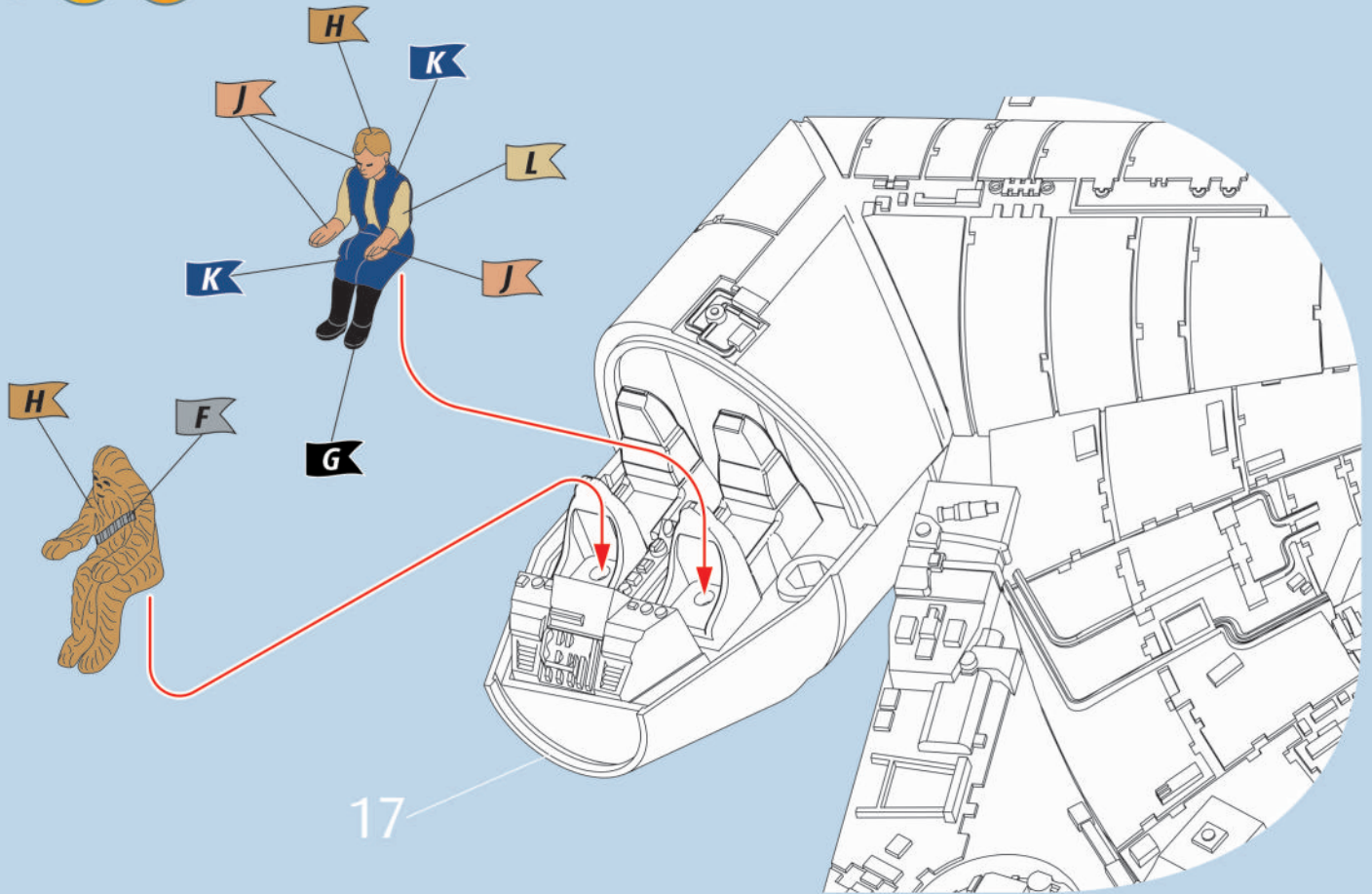

17

19

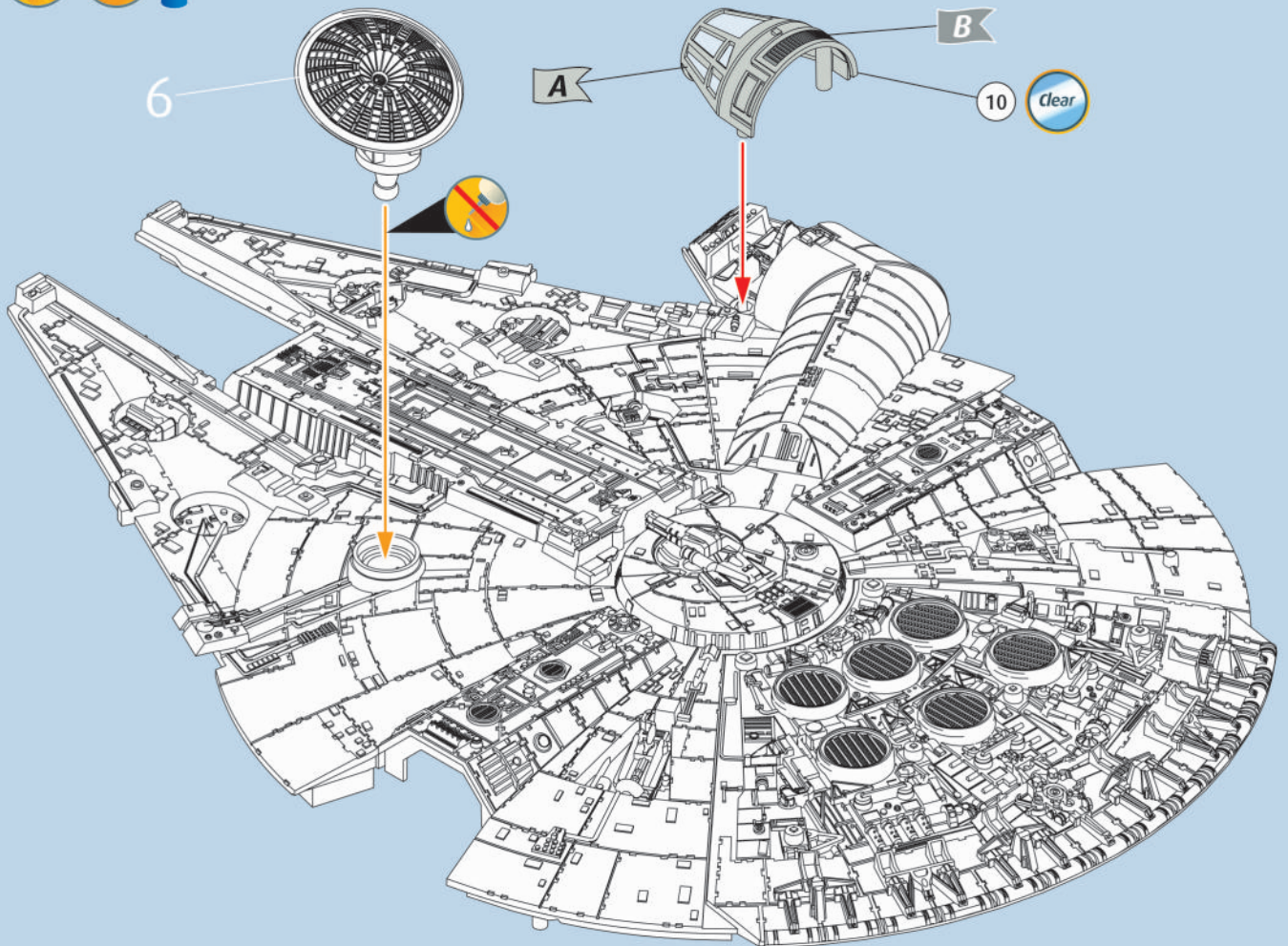

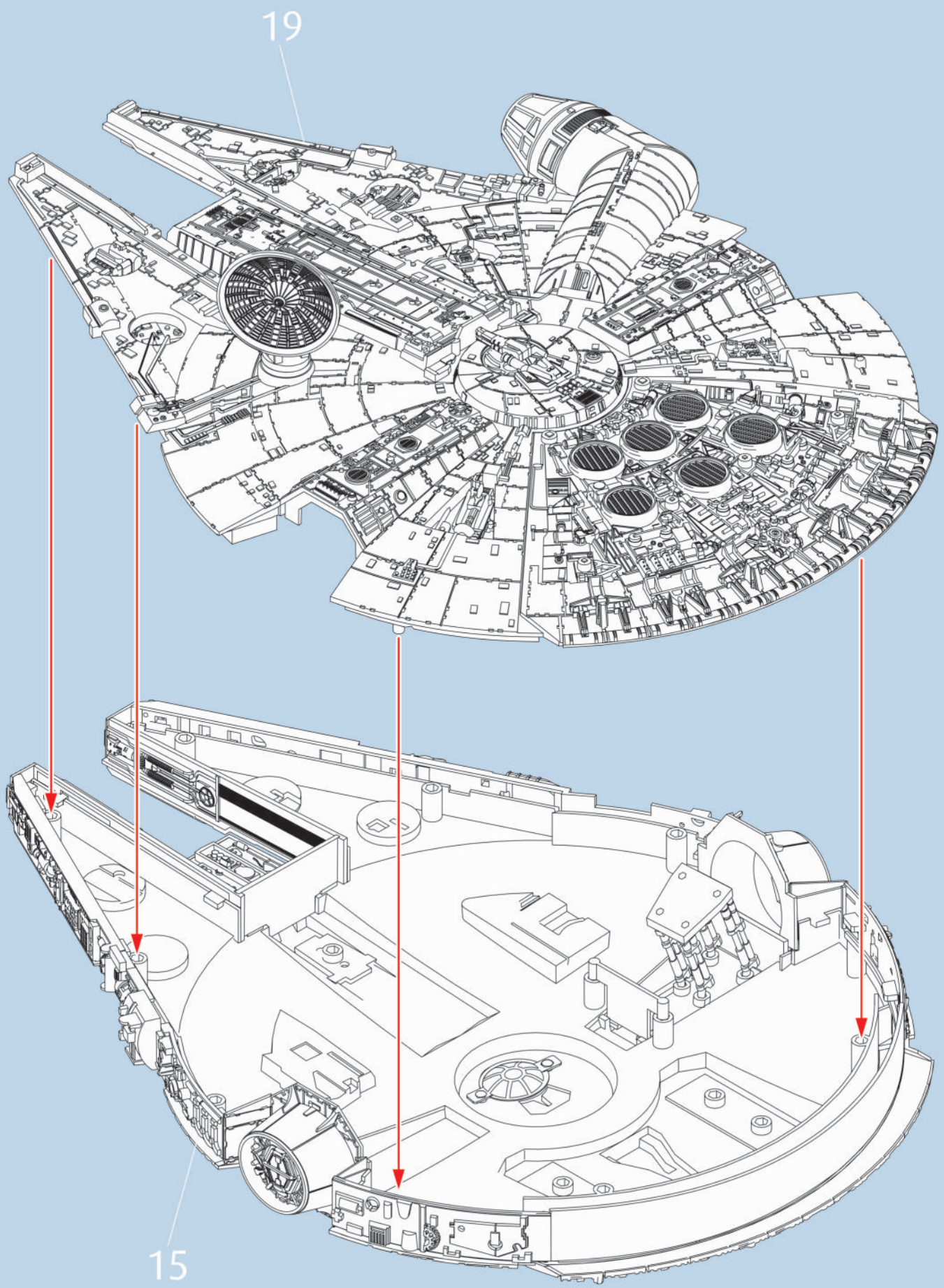



1.



M

2.



Abziehbild / decal

3.



N

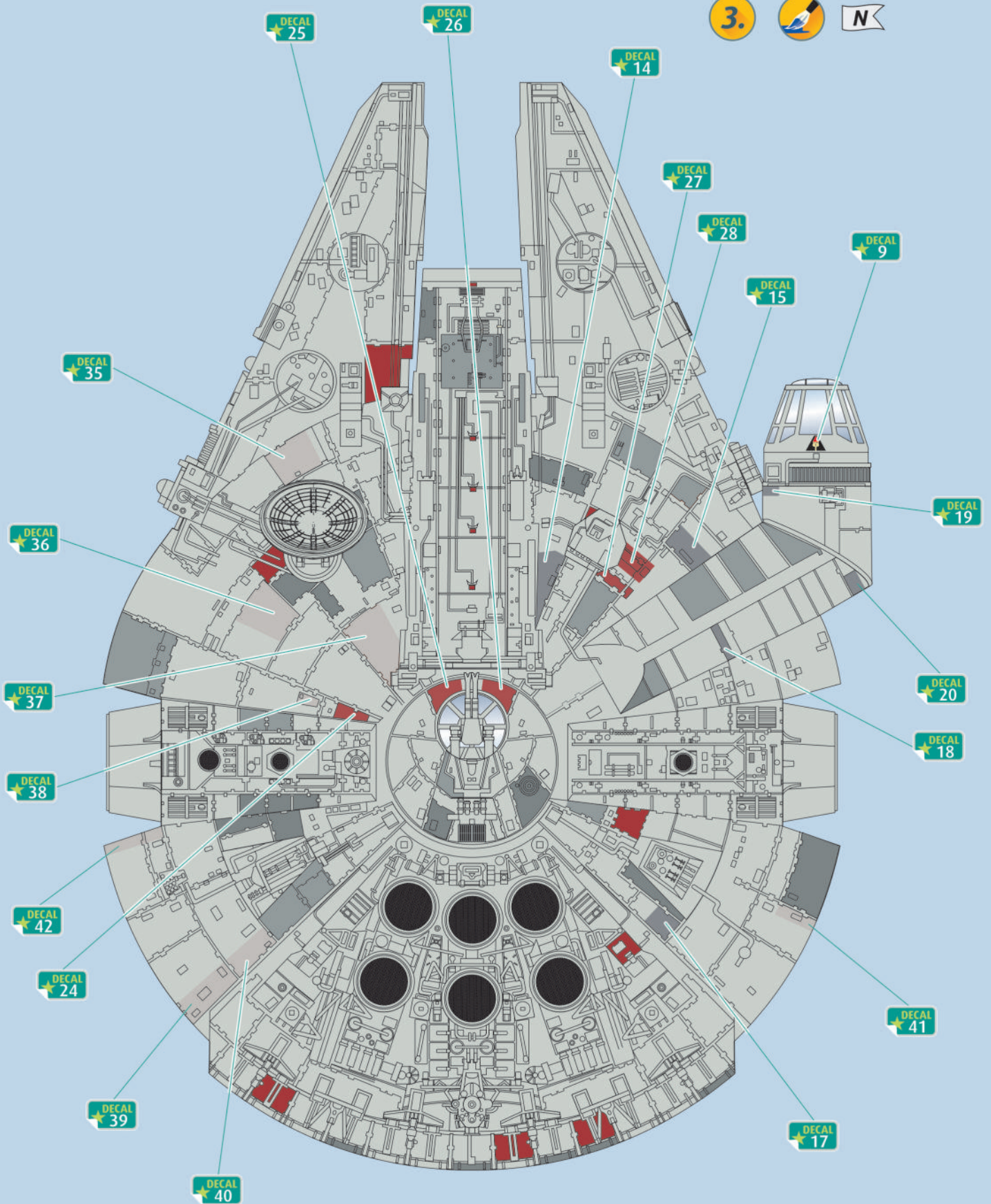



- 1. M
- 2. Abziehbild / decal
- 3. N

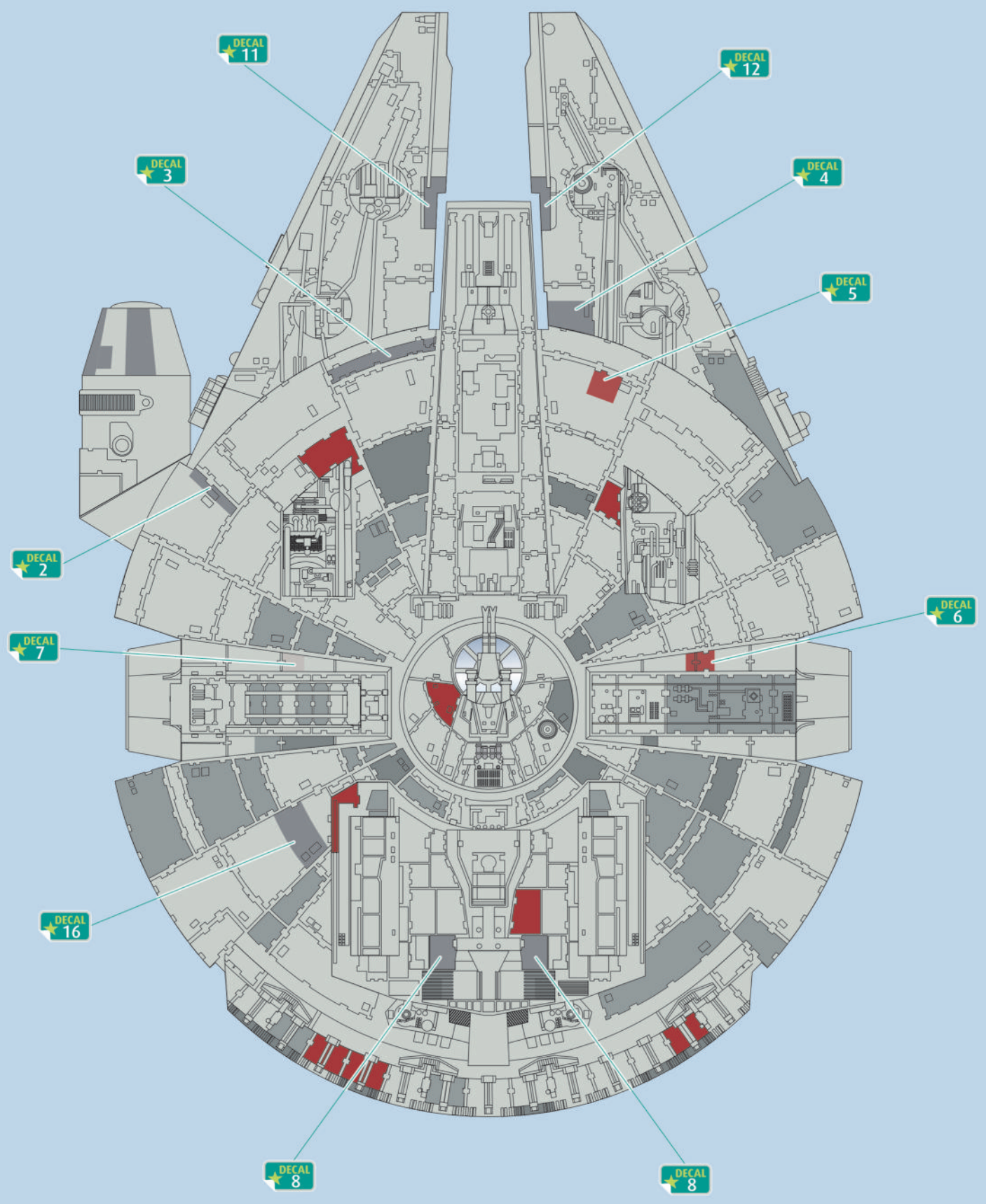



- 1.  
- 2.  

