

# STAR WARS

Revell

LEVEL 2

1 2 3 4 5

FROM THE NEW FILM  
STAR  
WARS  
THE FORCE AWAKENS



## MILLENNIUM FALCON™

easy  
kit



8+

© 2015 Revell GmbH, Henschelstr. 20-30, D-32257 Bünde. A subsidiary of Hobbico, Inc. REVELL IS THE REGISTERED TRADEMARK OF REVELL GMBH, GERMANY.  
[www.revell.de](http://www.revell.de)

[www.starwars.com](http://www.starwars.com)

© & ™ Lucasfilm Ltd

06694

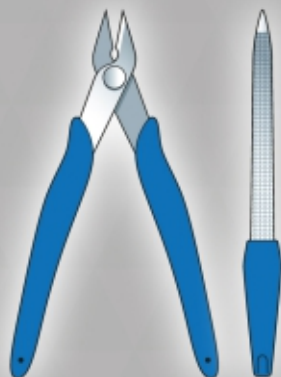

## ERSATZTEILE BENÖTIGT?

Kein Problem. Einfach den Revell-Service mit Angabe von Artikel- und Teilenummer kontaktieren. Entweder unter [service@revell.de](mailto:service@revell.de) oder Revell GmbH, Abteilung X, Henschelstr. 20-30, 32257 Bünde.\*

\*Wir bitten um Verständnis, dass eine Gewährleistung nur bei aktuellen Artikeln, die im Zeitraum der letzten 24 Monate erworben wurden, übernommen werden kann. Mit der Ersatzteil-Bestellung können Kosten z.B. für Verpackung und Versand entstehen. Ob diese Kosten anfallen wird im Vorfeld schriftlich durch unseren Service mitgeteilt. Das Angebot kann dann angenommen oder abgelehnt werden. Unfrei eingesandte Ersatzteil-Bestellungen werden von uns nicht angenommen! Dieser Direktservice gilt für die Länder Deutschland, Benelux, Österreich, Frankreich, Großbritannien. Ersatzteil-Bestellungen aus den übrigen Ländern werden über die jeweiligen Distributeure abgewickelt. Bitte kontaktieren Sie Ihren Händler.

## NEED SPARE PARTS?

No problem. Contact Revell Service with the item number and part numbers you need: [service@revell.de](mailto:service@revell.de) or Revell GmbH, Unit 10, Old Airfield Industrial Estate, Cheddington Lane, Tring, Herts, HP23 4QR, Great Britain.\*

\*We request your understanding that a warranty can only be accepted for current articles which have been purchased in the last 24 months. Orders for spare parts may also be subject to costs for packaging and shipping. You will be notified in advance by our Service department if such costs are incurred. The offer can then be accepted or rejected. We will not be able to process any postal requests unless correct postage has been applied to mailing! This direct service applies to the countries: Germany, Benelux, Austria, France, and the United Kingdom. Spare part orders from other countries are processed by the local distributors. Please contact your dealer.



- ☐ Klarsichtteile
- ☐ Clear parts
- ☐ Pièces transparentes
- ☐ Transparente onderdelen
- ☐ Parti trasparenti
- ☐ Piezas transparentes
- ☐ Peças transparentes
- ☐ Klare dele
- ☐ Klare deler
- ☐ Genomskinliga detaljer
- ☐ Lápinákyvát osát
- ☐ Прозрачные детали
- ☐ Przejroczyste części
- ☐ Průhledné díly
- ☐ Átlátszó alkatrészek
- ☐ Ćire diely
- ☐ Piese transparente
- ☐ Прозрачни части
- ☐ Przeworní deli
- ☐ Διαφανή μέρη
- ☐ Şeffaf parçalar



- ☐ Mit Klebeband fixieren.
- ☐ Attach with adhesive tape.
- ☐ Fixer à l'aide de ruban adhésif.
- ☐ Met plakband vastzetten.
- ☐ Fissare con nastro adesivo.
- ☐ Fijar con cinta adhesiva.
- ☐ Fixar com fita adesiva.
- ☐ Fastgør med tape.
- ☐ Fest med tape.
- ☐ Fixera med tejp.
- ☐ Kiinnittää liimanauhalla.
- ☐ Зафиксировать липкой лентой.
- ☐ Przymocować za pomocą taśmy samoprzylepnej.
- ☐ Pripevnéte lepicí páskou.
- ☐ Rögzítse ragasztószalaggal.
- ☐ Fixujte lepiacou páskou.
- ☐ Fixați cu bandă adezivă.
- ☐ Фиксируйте с тиксо.
- ☐ Pritrdite z lepilnim trakom.
- ☐ Στερώστε με κολλητική ταινία.
- ☐ Yapıştırma bandi ile sabitleyin.

## BESOIN DE PIÈCES DE RECHANGE ?

Il vous suffit de contacter le service Revell et d'indiquer la référence de l'article et de la pièce. Soit en écrivant par mail à [france@revell.de](mailto:france@revell.de) (uniquement pour la France) ou par courrier à Revell GmbH, Département X, Henschelstr. 20-30, D-32257 Bünde.\*

\*La garantie s'applique pour les articles présents au catalogue et achetés au cours des 24 derniers mois. Merci de votre compréhension. La commande de pièces de rechange peut donner lieu à des frais supplémentaires, par ex. pour l'emballage et le port. Notre service client vous en informera au préalable par écrit. Vous pourrez accepter ou refuser le devis. Nous n'acceptons pas les commandes de pièces de rechange envoyées sans affranchissement ! Ce service direct est valable pour les pays suivants : Allemagne, Benelux, Autriche, France, Grande-Bretagne. Les commandes de pièces en provenance d'autres pays sont traitées par les distributeurs correspondants. Veuillez contacter votre revendeur.

## HEBT U RESERVEONDERDELEN NODIG?

Geen probleem! Neem eenvoudig contact op met de klantenservice van Revell en geef ons het artikel- en onderdeelnummer door. U kunt ons bereiken op [service@revell.de](mailto:service@revell.de) of per post: Revell GmbH, Afdeling X, Henschelstr. 20-30, 32257 Bünde.\*

\*Wij vragen uw begrip voor de omstandigheid, dat er alleen garantie kan worden geboden voor actuele artikelen, die in de afgelopen 24 maanden zijn gekocht. Met het bestellen van reserveonderdelen kunnen kosten gemoeid zijn, bijv. voor verpakking en verzending. U wordt vooraf schriftelijk door onze klantenservice op de hoogte gesteld als er kosten zouden ontstaan. Het aanbod kan dan worden aangenomen of afgewezen. Wij nemen geen ongefrankeerde bestellingen van reserveonderdelen aan! Deze rechtstreekse service wordt verleend in de landen Duitsland, de Benelux, Oostenrijk, Frankrijk en Groot-Brittannië. Bestellingen van reserveonderdelen in de overige landen worden afgewikkeld via de betreffende distributeurs. Neem hiervoor contact op met uw verkoper.



- ☐ Zusammenbau Reihenfolge.
- ☐ Sequence of assembly.
- ☐ Ordre d'assemblage.
- ☐ Volgorde van montage.
- ☐ Sequenza di assemblaggio.
- ☐ Secuencia de montaje.
- ☐ Sequência de montagem.
- ☐ Samlerækkefølge.
- ☐ Monteringsrekkefølge.
- ☐ Montering ordningsføljd.
- ☐ Kokoamisjärjestys.
- ☐ Последовательность сборки.
- ☐ Kolejność montażu.
- ☐ Pořadí složení.
- ☐ Összerakási sorrend.
- ☐ Poradie zostavenia.
- ☐ Ordinea asamblării.
- ☐ Последовательность на сглобяване.
- ☐ Vrstni red sestavljanja.
- ☐ Σειρά τοποθέτησης.
- ☐ Parçaları birleştirme sırası.



- ☐ Wahlweise
- ☐ Optional
- ☐ Facultatif
- ☐ Naar keuze
- ☐ Facoltativamente
- ☐ Opcional
- ☐ Opțional
- ☐ Valgfri
- ☐ Valgfritt
- ☐ Valfri
- ☐ Valinnaisesti
- ☐ На выбор
- ☐ Opcjonalnie
- ☐ Volitelné
- ☐ Választás szerint
- ☐ Alternativne
- ☐ Optional
- ☐ По избор
- ☐ Izbirno
- ☐ Προαιρετικά
- ☐ Opsiyonel

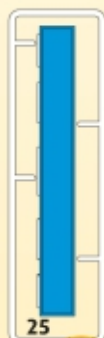
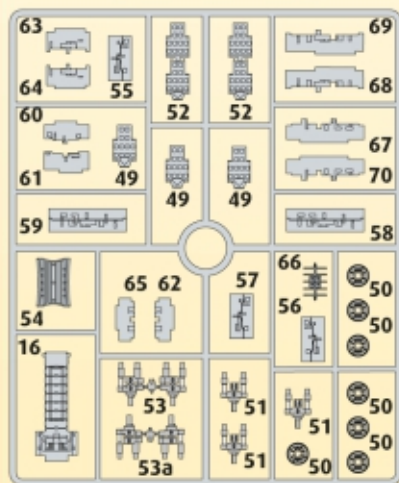
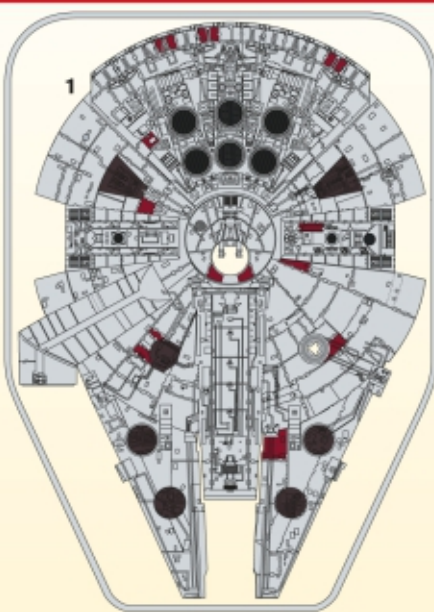
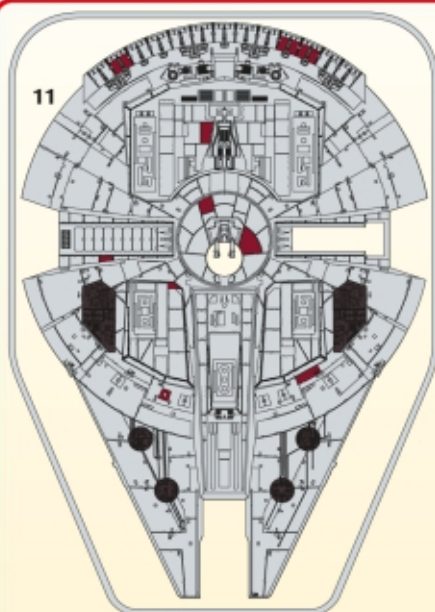

Clear

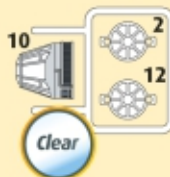

Clear

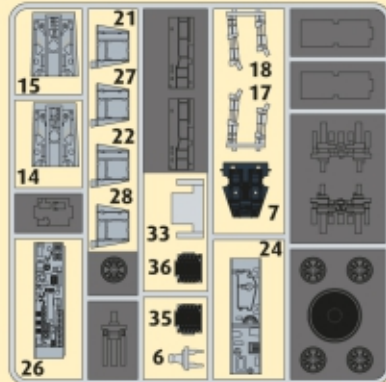
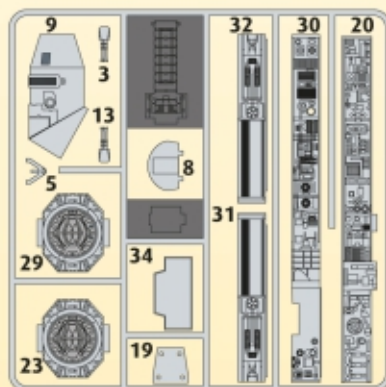

⊗ Nicht benötigte Teile

⊗ Parts not used.

⊗ Pièces non utilisées.

⊗ Niet benodigde onderdelen.

⊗ Parti non necessarie.

⊗ Piezas no utilizadas.

⊗ Peças não utilizadas.

⊗ Dele der ikke skal bruges.

⊗ Deler som ikke er nødvendige.

⊗ Ej nödvändiga delar.

⊗ Tarpeettomat osat.

⊗ Неиспользуемые детали.

⊗ Niepotrzebne części.

⊗ Nepotrebne díly.

⊗ Szükségtelen alkatrészek.

⊗ Nepotrebni dieli.

⊗ Piese care nu sunt necesare.

⊗ Ненужни детали.

⊗ Nepotrebni deli.

⊗ Μη χρησιμοποιούμενα μέρη.

⊗ Gerekl olmayan parçalar.

1

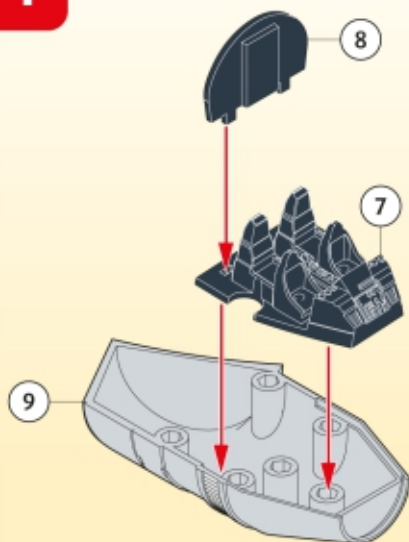

2

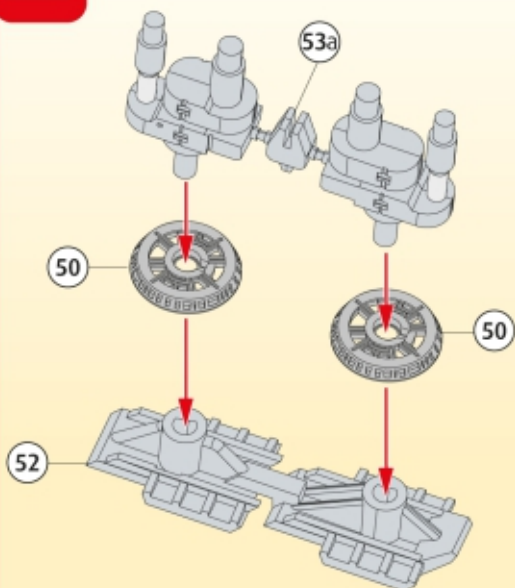

3

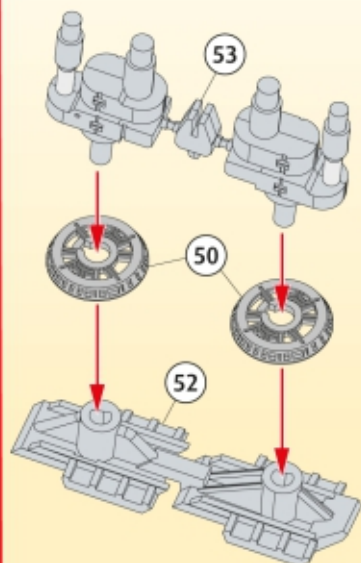

4

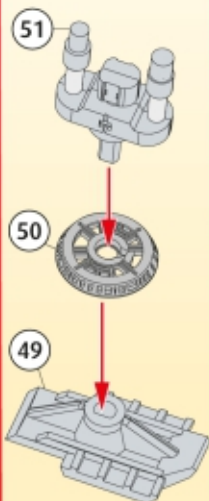

5

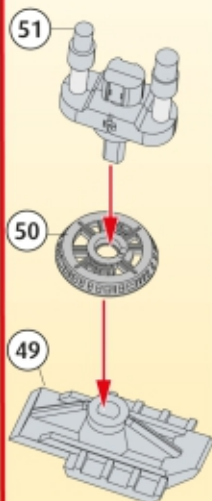

6

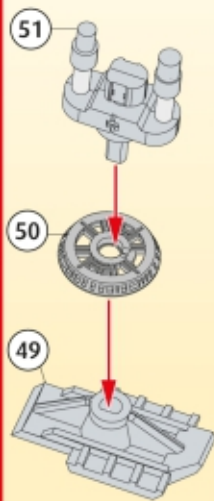

7

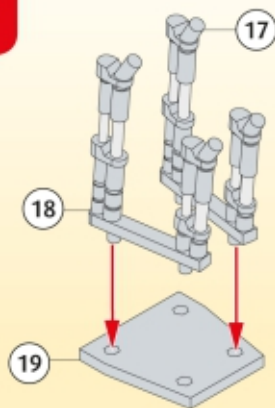

8

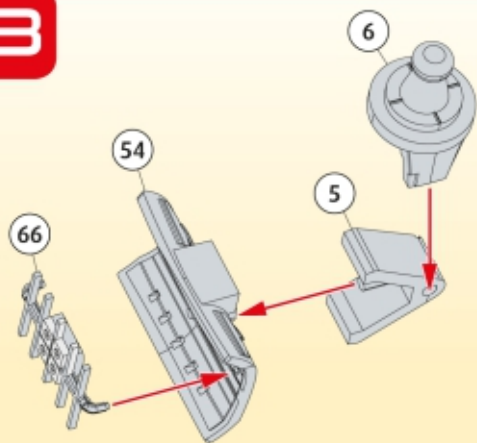

9

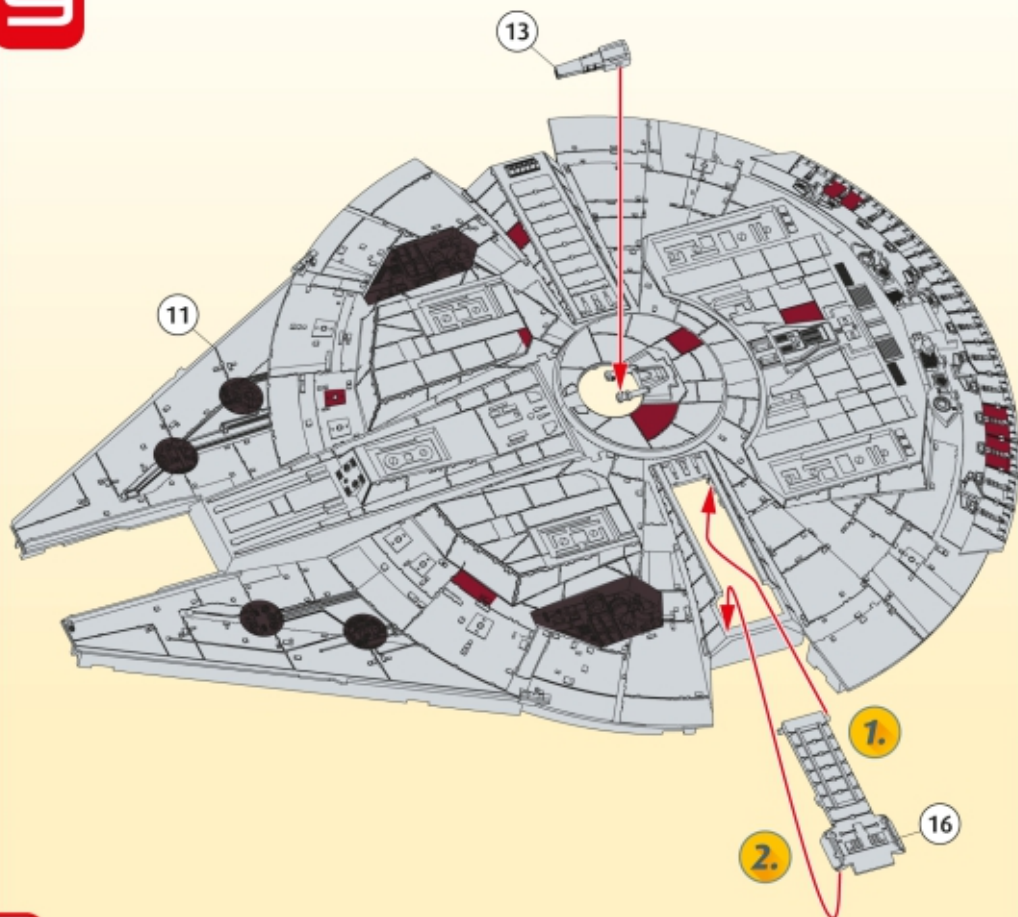

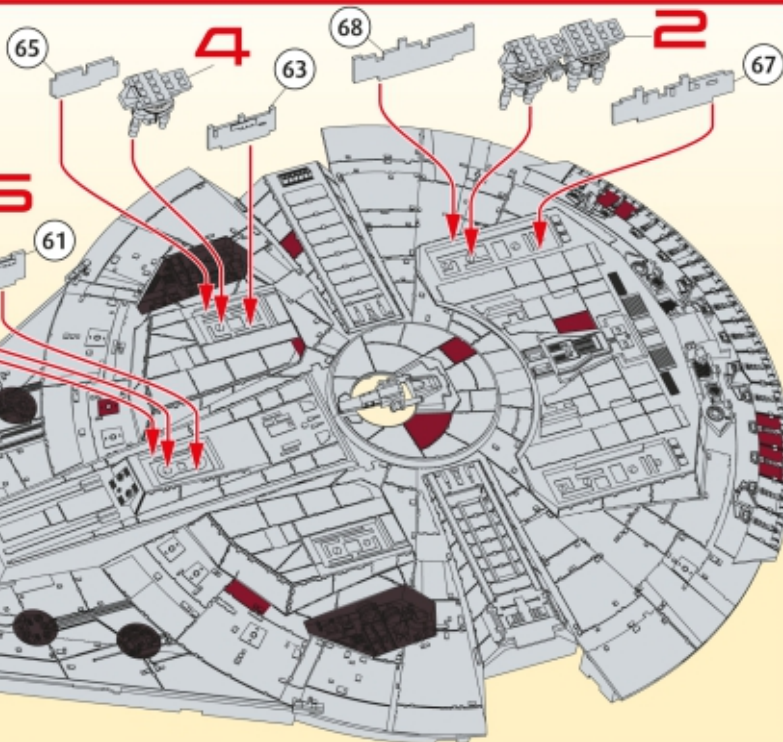
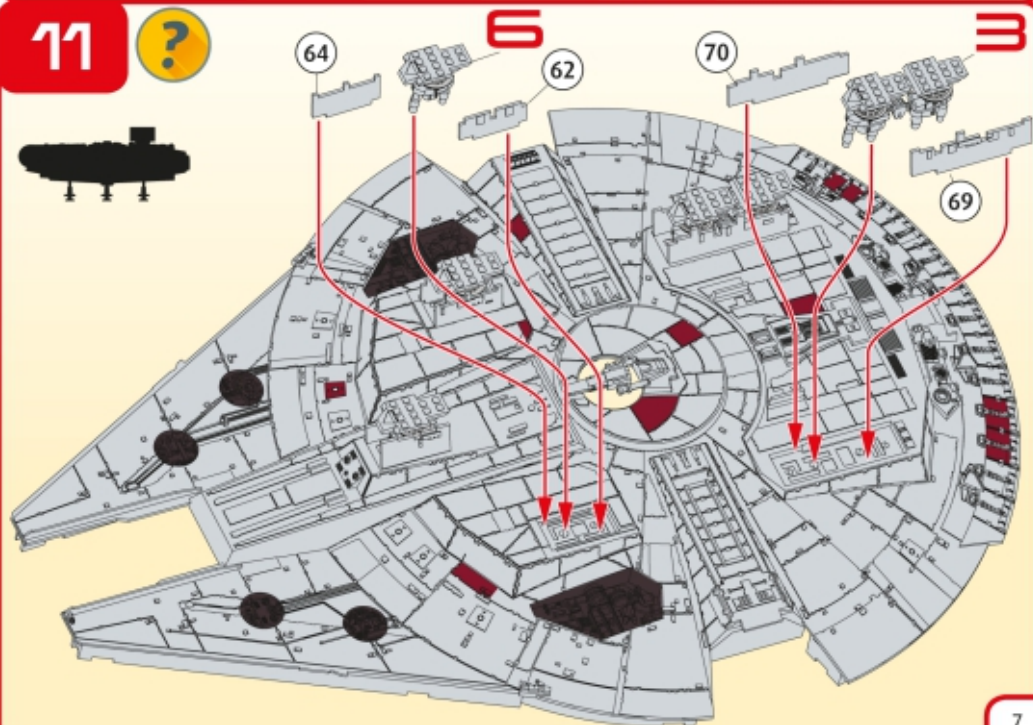
**10****11**

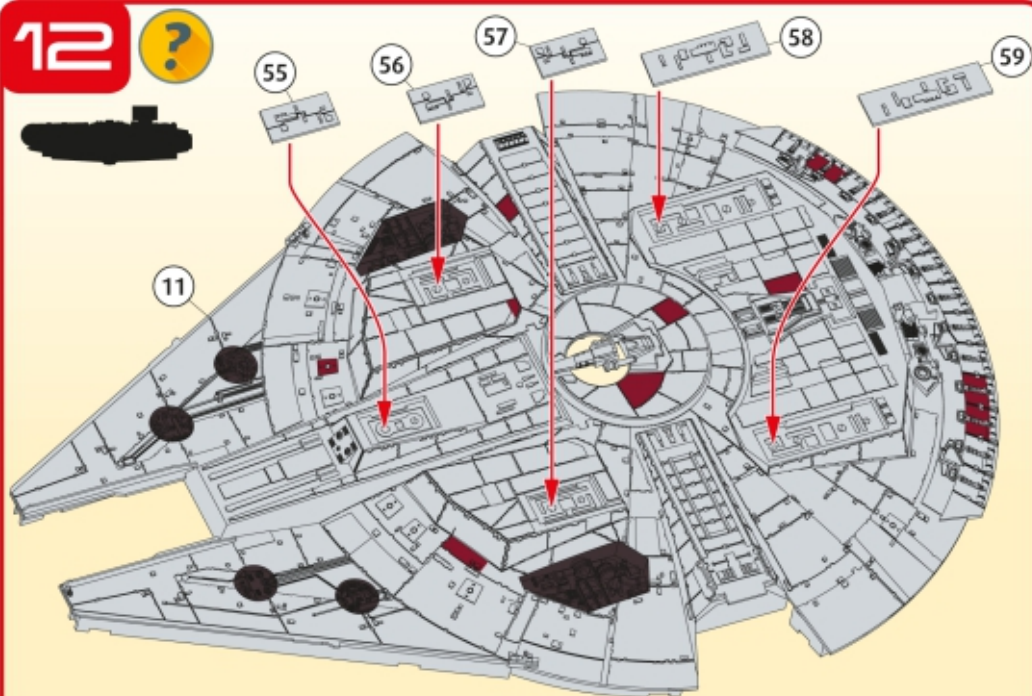
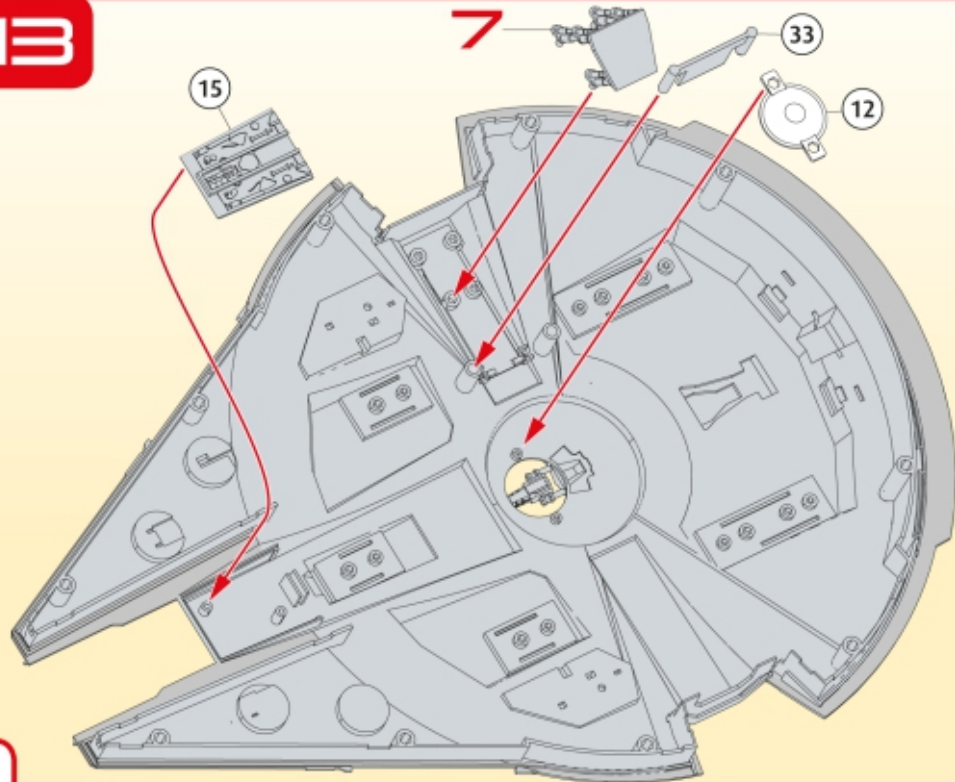
**12****13****7**



14

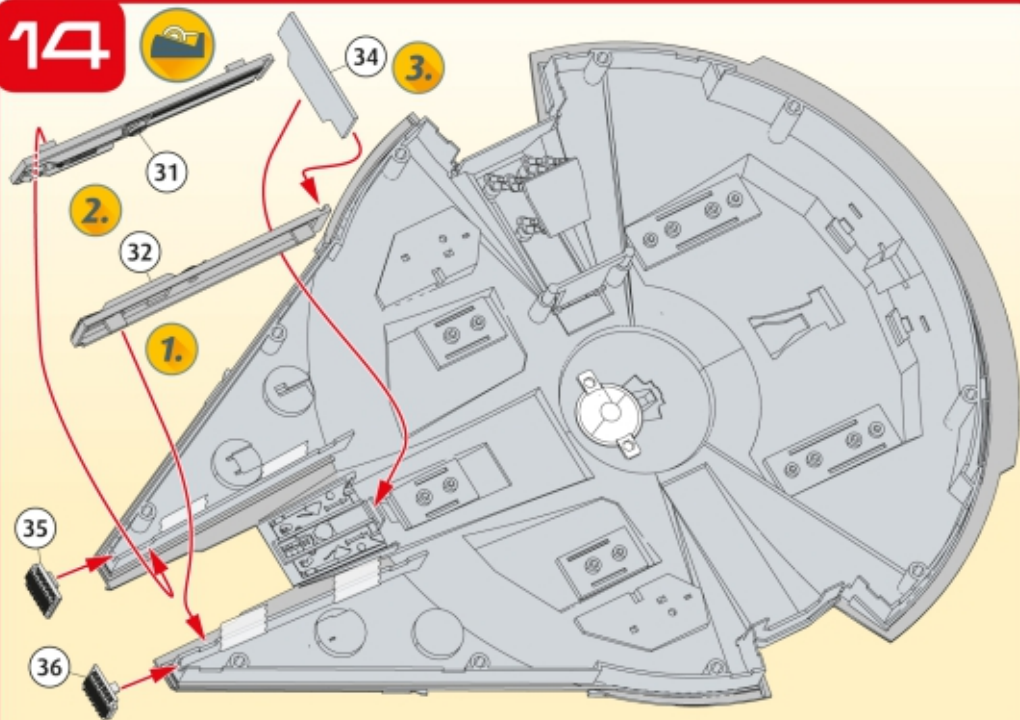

15

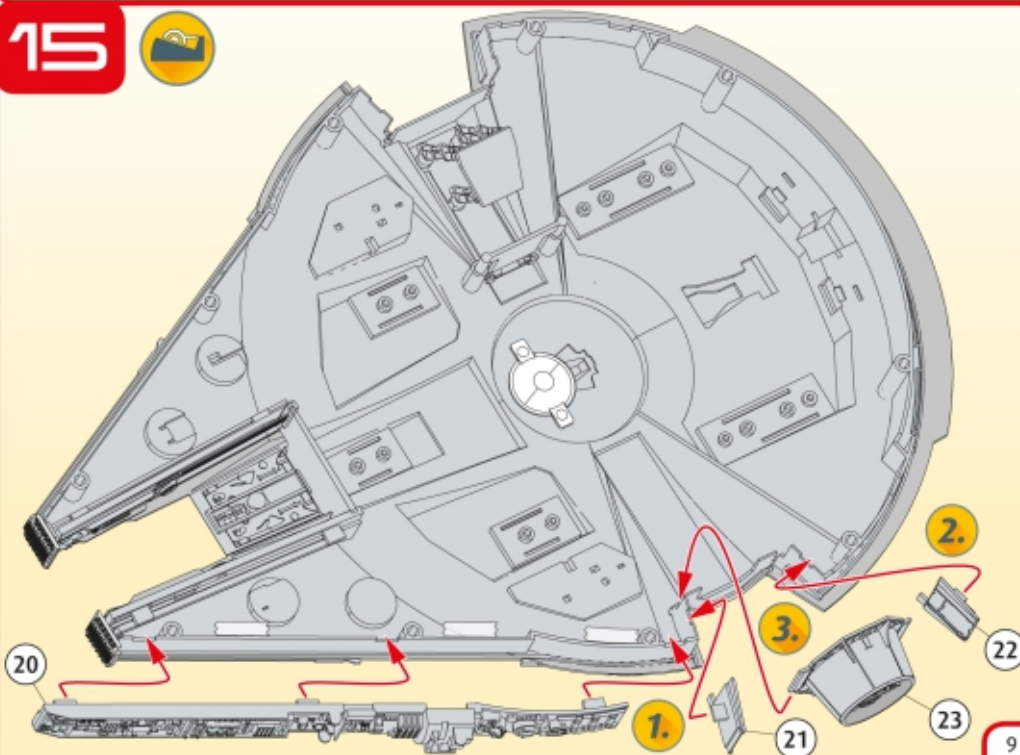

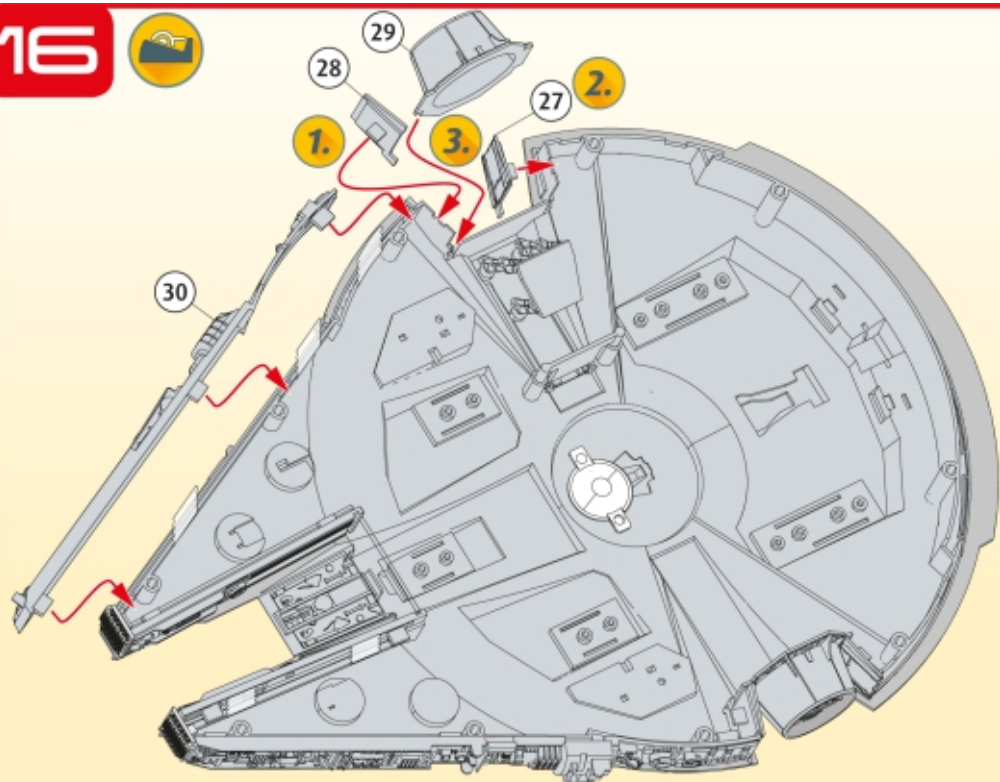
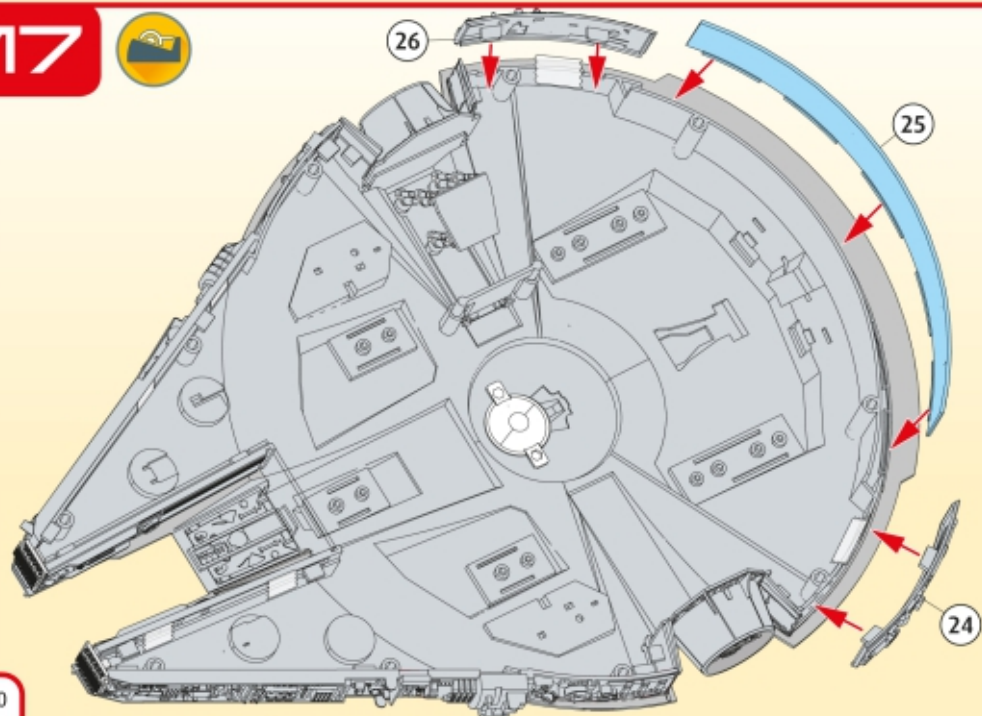
**16****17**

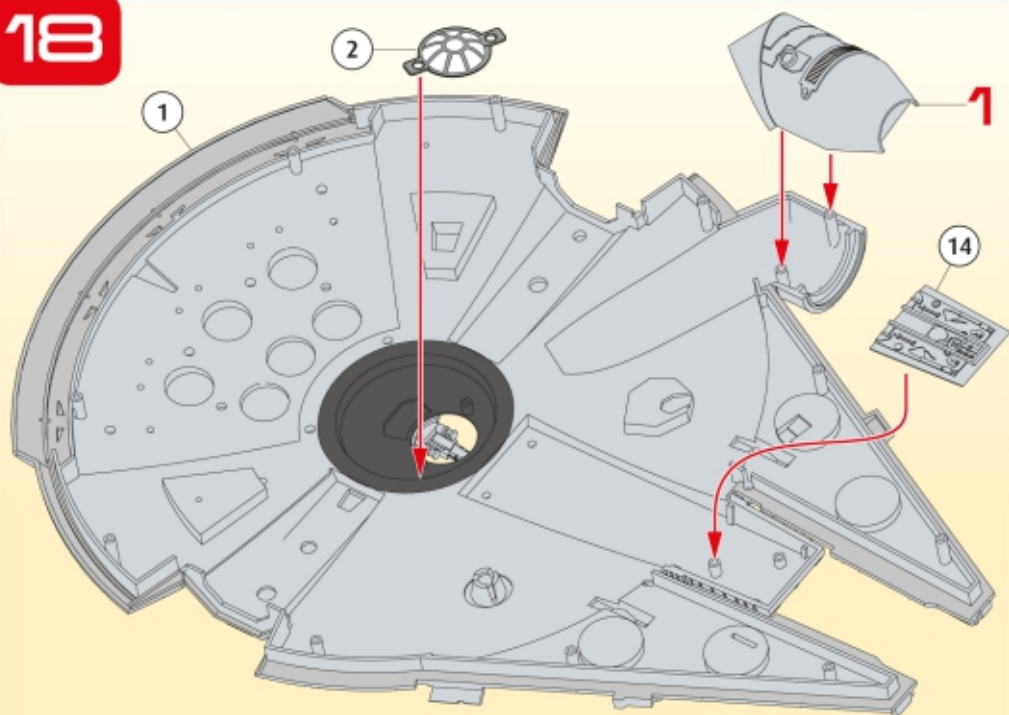
**18****19**