



05498-0379

**easy-click  
system**



# RMS TITANIC

Beiliegenden Sicherheitstext beachten / Please note the enclosed safety advice

- Ⓔ Beiliegenden Sicherheitstext beachten und nachschlagbereit halten.
- ⒸⓅ Please note the enclosed safety advice and keep safe for later reference.
- ⒻⓃ Respecter les consignes de sécurité ci-jointes et les conserver à portée de main.
- ⓃⓁ Houdt u aan de bijgaande veiligheidsinstructies en hou deze steeds bij de hand.
- ⓉⓉ Seguire le avvertenze di sicurezza allegate e tenerle a portata di mano.
- ⒺⓈ Observar y siempre tener a disposición este texto de seguridad adjunto.
- ⓉⓉ Ter em atenção o texto de segurança anexo e guardá-lo para consulta.
- ⒺⓃ Overhold vedlagte sikkerhedsanvisninger og hav dem liggende i nærheden.
- ⓃⓁⓃ Ha alltid vedlagt sikkerhetstekst klar til bruk.
- ⒺⓃ Beakta bifogad säkerhetstext och håll den i beredskap.
- ⒻⓃ Huomioi ja säilytä oheiset varoitukset.
- ⒻⓃ Соблюдать технику безопасности, сохранить инструкцию для дальнейших обращений.
- ⒻⓃ Przestrzegać załączonego tekstu dotyczącego bezpieczeństwa i mieć go zawsze pod ręką.
- ⒺⓃ Dodržujte tento příložený bezpečnostní text a mějte ho po ruce.
- ⒻⓃ A mellékelt biztonsági szöveget vegye figyelembe és tartsa fellapozásra készen.
- ⒺⓃ Respektujte příložený bezpečnostní text a uchovávejte ho pro budoucí použití.
- ⒻⓃ Respectați textul de siguranță atașat și păstrați-l la îndemână.
- ⒺⓃ Спазвайте приложениа текст за безопасност и го дръжте под ръка за справки.
- ⒺⓃ Priložena varnostna navodila izvajajte in jih hranite na vsem dostopnem mestu.
- ⒺⓃ Λάβετε υπόψη σας το συννημένο κείμενο ασφαλείας και φυλάξτε το ώστε να ανατρέχετε σε αυτό όποτε χρειάζεται.
- ⒻⓃ Ektekigüvenlik talimatlarını dikkate alıp, bakabileceğiniz bir şekilde muafaza ediniz.



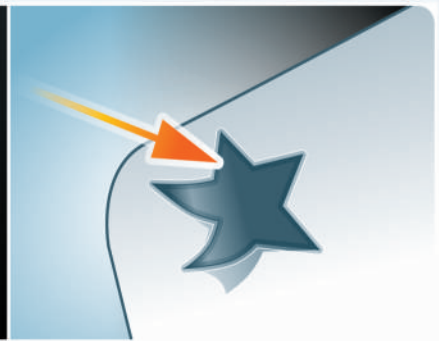
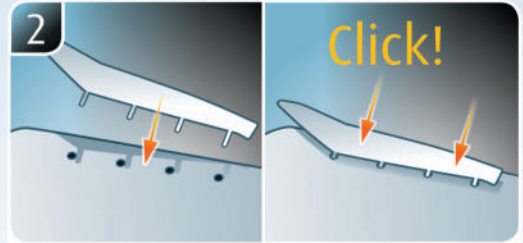
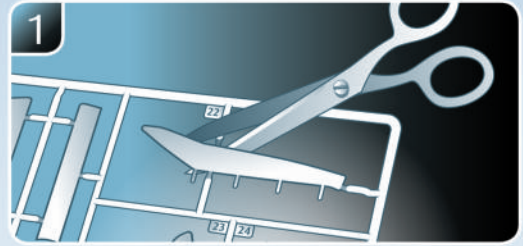
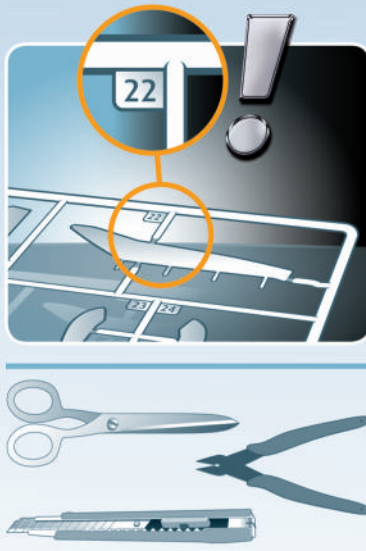

## Painting



## Decals

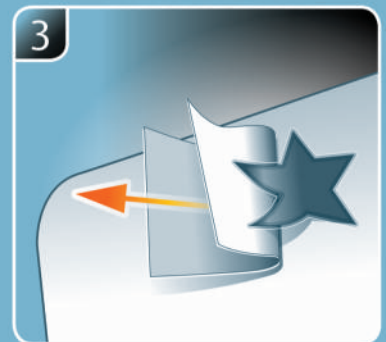
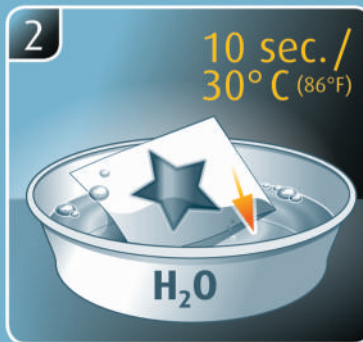
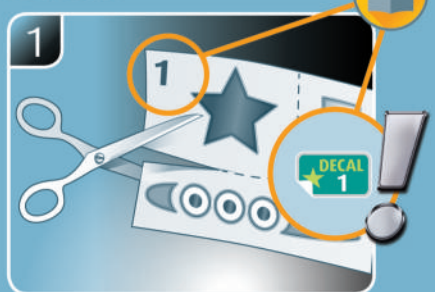

OPTIONAL · OPTIONAL · EN OPTION  
 OPTIONEEL · OPCIONAL · OPTIONAL \*



(DE) Weitere Tipps und Tricks.  
 (EN) Additional tips and tricks.  
 (FR) Conseils et astuces supplémentaires.  
 (NL) Andere tips en trucs.  
 (IT) Ulteriori consigli e suggerimenti.  
 (ES) Consejos y sugerencias adicionales.  
 (PT) Mais dicas e truques.  
 (NO) Flere tips og tricks.  
 (SE) Flere tips og tricks.  
 (YI) Ytterligere tips och tricks.  
 (FI) Lisää vinkkejä ja niksejä.  
 (RU) Другие советы и хитрости.

(PL) Dalsze wskazówki i sugestie.  
 (CZ) Další tipy a rady.  
 (HU) További ötletek és fogások.  
 (SK) Dalsie tipy a triky.  
 (RO) Alte sfaturi și trucuri.  
 (BG) Други полезни съвети и трикове.  
 (SI) Nadaljnji nasveti in zvijače.  
 (GR) Πρόσθετες συμβουλές και κόλπα.  
 (PL) Opcja.  
 (TR) Diğer öneriler ve ipuçları.

[www.revell.de](http://www.revell.de)

\* (PT) Opcional  
 (DK) Valgfrit  
 (NO) Valgfritt  
 (SE) Övrigt  
 (FI) Valinnainen  
 (RU) Дополнительно  
 (PL) Opcja  
 (CZ) Volitelný krok

(HU) Opcióként  
 (SK) Voliteľné  
 (RO) Opțional  
 (BG) Опция  
 (SI) Dodatno  
 (GR) Προαιρετικά  
 (TR) Opsiyonel



- DE Bemalen
- EN Paint
- FR Peindre
- NL Beschilderen
- IT Colorare
- ES Pintar
- PT Pintar
- DE Mal
- NO Male
- SE Måla
- FI Maalaa
- RU Раскрасить
- PL Pomalować
- CZ Pomalovat
- HU Fesse be
- NL Natrief
- NO Vopstij
- RU Боядисайте
- SI Pobarvajte
- GR Βάψτε
- TR Boyama



- DE Zusammenbau Reihenfolge.
- EN Sequence of assembly.
- FR Ordre d'assemblage.
- NL Volgorde van montage.
- IT Sequenza di assemblaggio.
- ES Secuencia de montaje.
- PT Sequência de montagem.
- DE Samlerækkefølge.
- NO Monteringsrekkefølge.
- SE Monteringsordningsföljd.
- FI Kokoamisjärjestys.
- RU Последовательность сборки.
- PL Kolejność montażu.
- CZ Pořadí složení.
- HU Összerakási sorrend.
- NL Poradie zostavenia.
- NO Ordinea asamblării.
- RU Последовательность на сглобяване.
- SI Vrstni red sestavljanja.
- GR Σειρά τοποθέτησης.
- TR Parçaları birleştirme sırası.



- DE Gleichen Vorgang auf der gegenüberliegenden Seite wiederholen.
- EN Repeat same procedure on opposite side.
- FR Opérer de la même façon sur l'autre face.
- NL Dezelfde handeling herhalen aan de tegenoverliggende kant.
- IT Ripetere il procedimento dall'altra parte.
- ES Repetir el mismo procedimiento en el lado contrario.
- PT Repetir alguns procedimentos no lado oposto.
- DE Gentag proceduren på den modstående side.
- NO Gjenta samme forløp på motliggende side.
- SE Upprepa samma process på motsatta sidan.
- FI Toista menettely vastakkaisella puolella.
- RU Повторить такие же действия на противоположной стороне.
- PL Powtórzyć te same czynności po przeciwnej stronie.
- CZ Stejný postup opakujte na protilehlé straně.
- HU Ismétélje meg a műveletet az ellentétes oldalon.
- NL Rovnaký postup zopakujte na protihledej strane.
- NO Repetati acelası procedeu pe latura opusă.
- RU Повторете същите стъпки на срещуположната страна.
- SI Enak postopek ponovite na nasprotni strani.
- GR Επανάλαβετε την ίδια διαδικασία στην αντίθετη πλευρά.
- TR Aynı işlem adımlarını diğer tarafta da uygulayın.



- DE Abziehbild in Wasser einweichen und anbringen.
- EN Soak and apply decals.
- FR Mouiller et appliquer les décalcomanies.
- NL Transfer in water even laten weken en aanbrengen.
- IT Immergere la decalcomania nell'acqua e applicarla.
- ES Mojar y aplicar calcomanías.
- PT Amolecer o decalque em água e aplicar.
- DE Gör överföringsbilledet vådt og sæt det på.
- NO Myk opp avtrekkingsbildet i vann og sett på.
- SE Blötlägg dekalen i vatten och sätt på den.
- FI Pehmitä siirtokuvua vedessä ja siirrä paikalleen.
- RU Опустите переводную картинку в воду и нанесите её.
- PL Namoczyc kalkomanie w wodzie i przykleic.
- CZ Nechte obtisk odmočit ve vodě a přilepte.
- HU Merítse vízbe és helyezze fel a matricát.
- NO Öbtläckový obrázok namočte do vody a priložite na plochu.
- NO Inmuaiați abțibildul în apă și aplicați-l.
- NO Потопете ваденката във вода и я поставете.
- SI Prelepnicu namakajte v vodi. In namestite
- GR Μοισκέψτε σε νερό και τοποθετήστε τις χαλκομανίες.
- TR Çıkartmayı suda yumuşatın ve takın.



- DE Zur Anbringung der Abziehbilder empfohlen.
- EN Recommended for affixing the decals.
- FR Recommandé pour l'application des décalcomanies.
- NL Aanbevolen voor het aanbrengen van de transfers.
- IT Raccomandato per l'applicazione delle decalcomanie.
- ES Recomendado para fijar bien las calcomanías.
- PT Recomendado para a fixação dos autocolantes.
- DE Anbefales til anbringelse af overføringsbillederne.
- NO Anbefales til å feste avtrekksbilder.
- SE Rekommenderad för montering av klisterdekalerna.
- FI Suositellaan siirtokuvien siirtämiseen.
- RU Рекомендуется для нанесения переводных картинок.
- PL Zalecane do przyklejenia kalkomanii.
- CZ Doporučujeme k umístění obtiskovacích obrázků.
- HU A matrica felhelyezéséhez ajánlható.
- NO Odporúča sa pre umiestnenie obtläckovéhó obrázku.
- NO Recomandat pentru aplicarea abțibildurilor.
- NO Препоръчва се за поставяне на ваденки.
- SI Pri nameščanju nalepnic je priporočato.
- GR Συνιστάται για την τοποθέτηση των χαλκομανιών.
- TR Çıkartmaların takılması için önerilir.



- DE Nicht enthalten
- EN Not included
- FR Non fourni
- NL Behoort niet tot de levering
- IT Non incluso

- ES No incluido
- PT Não incluído
- DE Medfølger ikke
- NO Ikke inkludert
- SE Ingår ej
- FI Ei sisällä

- RU Не содержится
- PL Nie wchodzi w zakres dostawy
- CZ Není obsaženo
- HU Nem tartalmazza
- NO Neobsahuje

- NO Nu este inclus
- NO Не се включва в комплекта
- SI Ni priloženo
- GR Δεν περιλαμβάνεται
- TR İçermiyor



**OPTIONAL · OPTIONAL · EN OPTION · OPTIONEEL · OPCIONAL · OPTIONAL \***

☞ Optional kann das Modell zusätzlich bemalt werden und wird damit zum ganz persönlichen Unikat. Wir empfehlen folgende Revell-Farben:

☞ The model can also be painted, which makes it completely unique. We recommend the following Revell paints:

☞ En option, il est aussi possible de peindre le modèle. Il devient alors une pièce vraiment unique et personnalisée. Nous vous recommandons les couleurs Revell suivantes :

☞ Optioneel kan het model aanvullend worden beschilderd om het een heel persoonlijke, unieke uitstraling te geven. Wij bevelen de volgende verf van Revell aan:

☞ Opcionalmente, el modelo se puede pintar para convertirlo en una pieza única personalizada. Recomendamos las siguientes pinturas de Revell:

☞ In via opzionale il modellino può essere verniciato per ottenere un esemplare del tutto personalizzato. Consigliamo di utilizzare i seguenti colori Revell:

☞ Opcionalmente, o modelo pode ser ainda pintado, dando-lhe um caráter pessoal único. Recomendamos as seguintes tintas Revell:

☞ Du kan vælge også at male modellen, som på den måde bliver personlig og unik. Vi anbefaler følgende Revell-farver:

☞ Du har mulighed til å gjøre modellen helt unik ved å male den. Vi anbefaler følgende Revell-farger:

☞ Modellen kan även målas och därmed bli en helt unik Unikat. Vi rekommenderar följande Revell-färger:

☞ Jos haluat yksilöllisen lopputuloksen, voit halutessasi myös maalata mallin. Suosittelemme käyttämään seuraavia Revell-maaleja:

☞ В качестве дополнения модель может быть окрашена, что придаст ей персональные, уникальные черты. Мы рекомендуем следующие цвета Revell:

☞ Opcjonalnie można dodatkowo pomalować model, który dzięki temu będzie całkowicie osobistym unikatem. Polecamy następujące farby Revell:

☞ Model se může dodatečně pomalovat, čímž vznikne zcela jedinečný originál. Doporučujeme použít barvy značky Revell:

☞ Opcióként a modell kiegészítő festéssel is ellátható, így igazán egyedivé tehető. Ehhez a következő Revell festékeket ajánljuk:

☞ Model sa môže dodatočne pomalovať, čím vznikne celkom jedinečný originál. Odporúčame použiť tieto farby značky Revell:

☞ Opțional, pentru un aspect unic, personalizat, pe model se poate aplica un strat suplimentar de vopsea. Vă recomandăm următoarele vopsele Revell:

☞ Опціонално моделът може допълнително да бъде изпълнен в друг цвят и да се превърне в абсолютен уникат. Препоръчваме следните цветове на Revell:

☞ Po želji je moguće model dodatno prebarviti in ga tako spremeniti v osebni unikat. Priporočamo naslednje barve Revell:

☞ Προαιρετικά μπορεί το μοντέλο να βαφεί και να γίνει ένα τελείως προσωπικό μοναδικό κομμάτι. Συνιστούμε τα παρακάτω χρώματα Revell:

☞ Opsiyonel olarak model boyanabilir ve benzersiz hale getirilebilir. Şu Revell renklerini tavsiye ediyoruz:

301

A

- ☞ Weiß seidenmatt
- ☞ White silk matt
- ☞ Blanc satiné mat
- ☞ Wit zijdemat
- ☞ Bianco opaco satinato
- ☞ Blanco mate satinado
- ☞ Branco mate sedoso
- ☞ Hvid silkematt
- ☞ Hvit silkematt
- ☞ Vit sidenmatt
- ☞ Valkoinen silkkimatta
- ☞ Белый шелковисто-матовый
- ☞ Biały jedwabście matowy
- ☞ Bílá jemně matný
- ☞ Fehér, fakóselymes
- ☞ Biela hodvábné matný
- ☞ Alb satinat
- ☞ Бяло коприненоматово
- ☞ Siva svilenomat
- ☞ Ασπρο σατινέ
- ☞ Beyaz ipeksi mat

374

B

- ☞ Grau seidenmatt
- ☞ Grey silk matt
- ☞ Gris satiné mat
- ☞ Grijs zijdemat
- ☞ Grigio opaco satinato
- ☞ Gris mate satinado
- ☞ Cinzento mate sedoso
- ☞ Grå silkematt
- ☞ Grå silkematt
- ☞ Grå sidenmatt
- ☞ Harmaa silkkimatta
- ☞ Серый шелковисто-матовый
- ☞ Szary jedwabście matowy
- ☞ Šedá jemně matný
- ☞ Szürke, fakóselymes
- ☞ Sivá hodvábné matný
- ☞ Gri satinat
- ☞ Сиво коприненоматово
- ☞ Siva svilenomat
- ☞ Γκρι σατινέ
- ☞ Gri ipeksi mat

91

C

- ☞ Eisen metallic
- ☞ Iron metallic
- ☞ Fer métallique
- ☞ IJzer metallic
- ☞ Ferro metallico
- ☞ Acero metálico
- ☞ Aço metálico
- ☞ Stål metallisk
- ☞ Jern metallic
- ☞ Stål metallic
- ☞ Teräs metallinen
- ☞ Сталь металллик
- ☞ Grafit metaliczny
- ☞ Ocelová metalizovaný
- ☞ Acélmetál
- ☞ Ocelová metaliza
- ☞ Fier metallic
- ☞ Желязо металик
- ☞ Železna kovinska
- ☞ Χρώμα σιδήρου μεταλλικό
- ☞ Metalik metalik

92

D

- ☞ Messing metallic
- ☞ Brass metallic
- ☞ Laiton métallique
- ☞ Messing metallic
- ☞ Ottono metallico
- ☞ Latón metálico
- ☞ Latão metálico
- ☞ Messing metallisk
- ☞ Messing metallic
- ☞ Mässing metallic
- ☞ Messinki metallinen
- ☞ Латунь металллик
- ☞ Mosiądz metaliczny
- ☞ Mosazná metalizovaný
- ☞ Sárgaréz metál
- ☞ Mosazná metaliza
- ☞ Alámiu metallic
- ☞ Месинг металик
- ☞ Medeninasta kovinska
- ☞ Χρώμα ορείχαλκου μεταλλικό
- ☞ Pirinc rengi metalik

378

E

- ☞ Dunkelgrau seidenmatt
- ☞ Dark grey silk matt
- ☞ Gris foncé satiné mat
- ☞ Donkergrijs zijdemat
- ☞ Grigio scuro opaco satinato
- ☞ Gris oscuro mate satinado
- ☞ Cinza escuro mate sedoso
- ☞ Mørkegrå silkematt
- ☞ Mørk grå silkematt
- ☞ Mörkgrå sidenmatt
- ☞ Tummanharmaa silkkimatta
- ☞ Тёмно-серый шелковисто-матовый
- ☞ Ciemnoszary jedwabście matowy
- ☞ Tmavá šedá jemně matný
- ☞ Sötétszürke, fakóselymes
- ☞ Tmavo sivá hodvábné matný
- ☞ Gri-inchis satinat
- ☞ Тъмносиво коприненоматово
- ☞ Temno-siva svilenomat
- ☞ Γκρι σκούρο σατινέ
- ☞ Koyu gri ipeksi mat

\* ☞ Opcional  
☞ Valgfrit  
☞ Valgfritt

☞ Övrigt  
☞ Valinnainen  
☞ Дополнительно

☞ Opcja  
☞ Voliteľný krok  
☞ Opcióként

☞ Voliteľné  
☞ Opțional  
☞ Опция

☞ Dodatno  
☞ Προαιρετικά  
☞ Opsiyonel



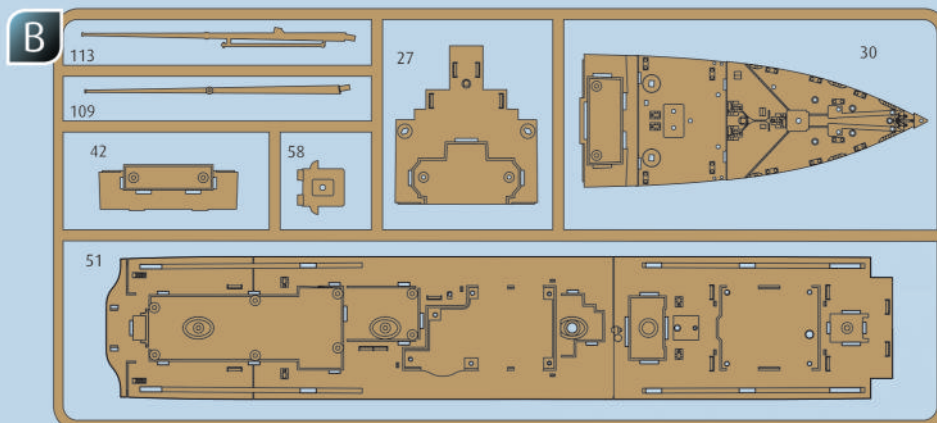
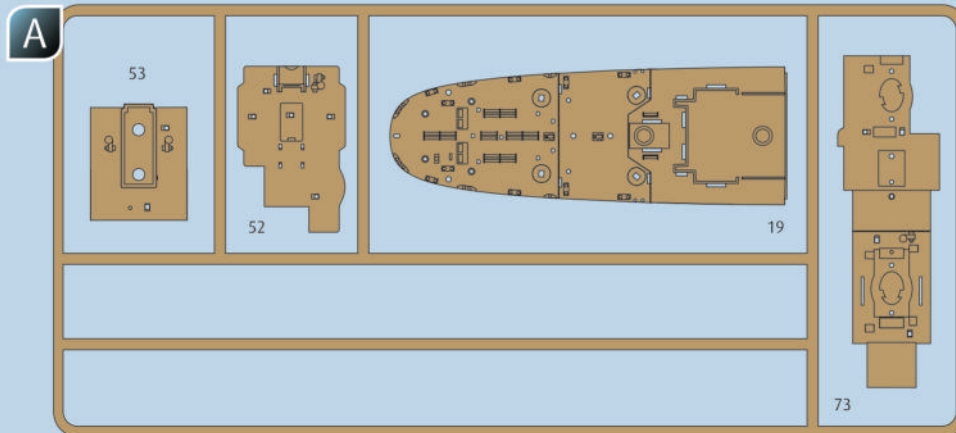
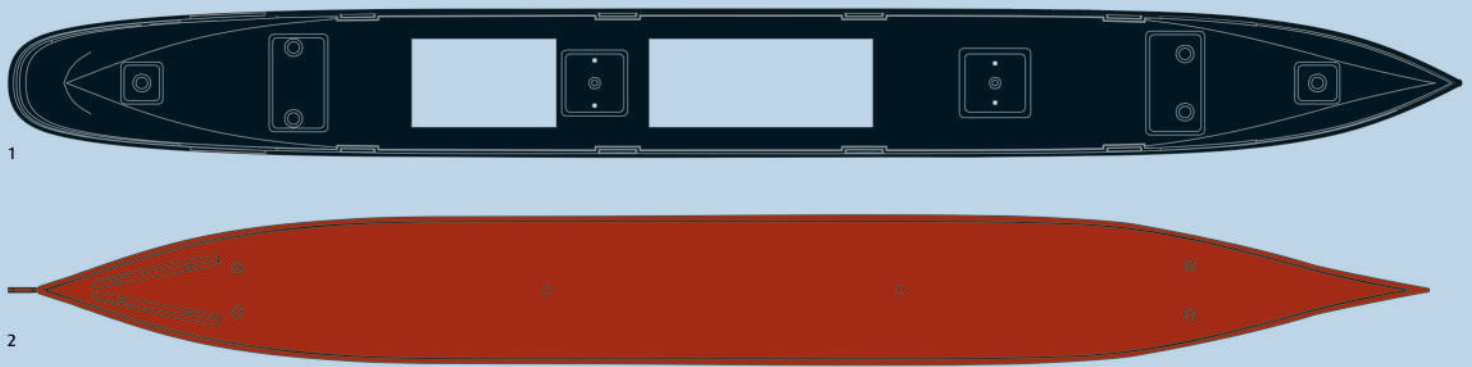

### Ersatzteile benötigt?

Kein Problem. Einfach den Revell-Service mit Angabe von Artikel- und Teilenummer kontaktieren. Entweder unter [service@revell.de](mailto:service@revell.de) oder Revell GmbH, Abteilung X, Henschelstr. 20-30, 32257 Bünde.\*

\*Wir bitten um Verständnis, dass eine Gewährleistung nur bei aktuellen Artikeln, die im Zeitraum der letzten 24 Monate erworben wurden, übernommen werden kann. Mit der Ersatzteil-Bestellung können Kosten z.B. für Verpackung und Versand entstehen. Ob diese Kosten anfallen wird im Vorfeld schriftlich durch unseren Service mitgeteilt. Das Angebot kann dann angenommen oder abgelehnt werden. Unfrei eingesandte Ersatzteil-Bestellungen werden von uns nicht angenommen! Dieser Direktservice gilt für die Länder Deutschland, Benelux, Österreich, Frankreich, Großbritannien. Ersatzteil-Bestellungen aus den übrigen Ländern werden über die jeweiligen Distributeure abgewickelt. Bitte kontaktieren Sie Ihren Händler.

### Besoin de pièces de rechange ?

Il vous suffit de contacter le service Revell et d'indiquer la référence de l'article et de la pièce. Soit en écrivant par mail à [france@revell.de](mailto:france@revell.de) (uniquement pour la France) ou par courrier à Revell GmbH, Département X, Henschelstr. 20-30, D-32257 Bünde.\*

\*La garantie s'applique pour les articles présents au catalogue et achetés au cours des 24 derniers mois. Merci de votre compréhension. La commande de pièces de rechange peut donner lieu à des frais supplémentaires, par ex. pour l'emballage et le port. Notre service client vous en informera au préalable par écrit. Vous pourrez accepter ou refuser le devis. Nous n'acceptons pas les commandes de pièces de rechange envoyées sans affranchissement ! Ce service direct est valable pour les pays suivants : Allemagne, Benelux, Autriche, France, Grande-Bretagne. Les commandes de pièces en provenance d'autres pays sont traitées par les distributeurs correspondants. Veuillez contacter votre revendeur.

### Need spare parts?

No problem. Contact Revell Service with the item number and part numbers you need: [service@revell.de](mailto:service@revell.de) or Revell GmbH, Unit 10, Old Airfield Industrial Estate, Cheddington Lane, Tring, Herts, HP23 4QR, Great Britain.\*

\*We request your understanding that a warranty can only be accepted for current articles which have been purchased in the last 24 months. Orders for spare parts may also be subject to costs for packaging and shipping. You will be notified in advance by our Service department if such costs are incurred. The offer can then be accepted or rejected. We will not be able to process any postal requests unless correct postage has been applied to mailing! This direct service applies to the countries: Germany, Benelux, Austria, France, and the United Kingdom. Spare part orders from other countries are processed by the local distributors. Please contact your dealer.

### Hebt u reserveonderdelen nodig?

Geen probleem! Neem eenvoudig contact op met de klantenservice van Revell en geef ons het artikel- en onderdeelnummer door. U kunt ons bereiken op [service@revell.de](mailto:service@revell.de) of per post: Revell GmbH, Afdeling X, Henschelstr. 20-30, 32257 Bünde.\*

\*Wij vragen uw begrip voor de omstandigheid, dat er alleen garantie kan worden geboden voor actuele artikelen, die in de afgelopen 24 maanden zijn gekocht. Met het bestellen van reserveonderdelen kunnen kosten gemoeid zijn, bijv. voor verpakking en verzending. U wordt vooraf schriftelijk door onze klantenservice op de hoogte gesteld als er kosten zouden ontstaan. Het aanbod kan dan worden aangenomen of afgewezen. Wij nemen geen ongefrankeerde bestellingen van reserveonderdelen aan! Deze rechtstreekse service wordt verleend in de landen Duitsland, de Benelux, Oostenrijk, Frankrijk en Groot-Brittannië. Bestellingen van reserveonderdelen in de overige landen worden afgewikkeld via de betreffende distributeurs. Neem hiervoor contact op met uw verkoper.



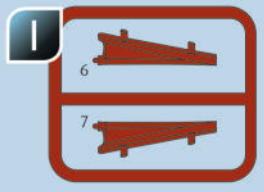
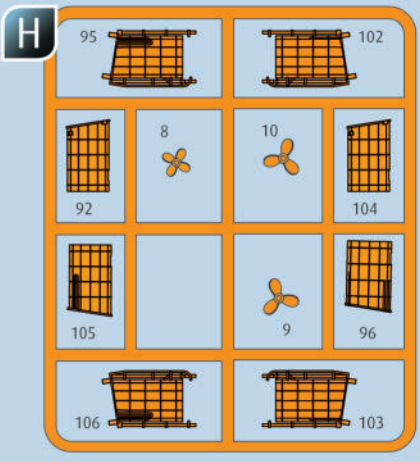
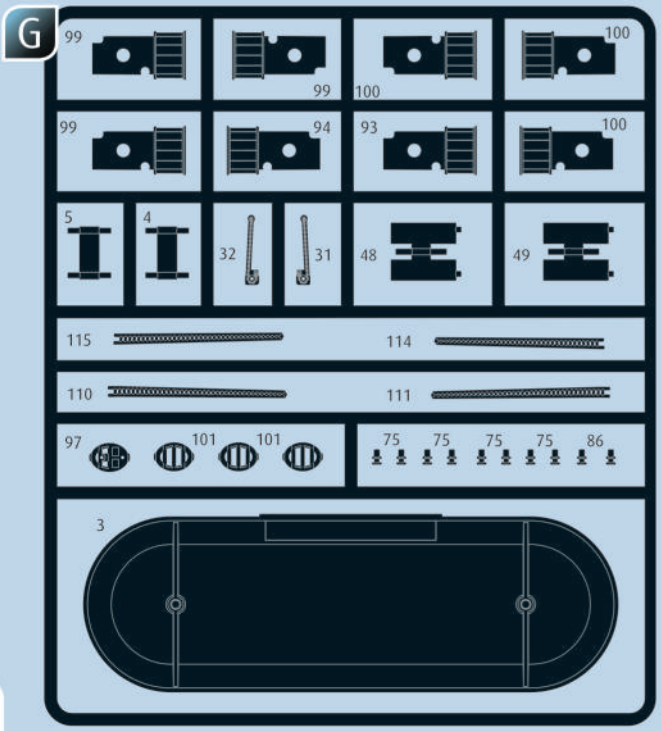
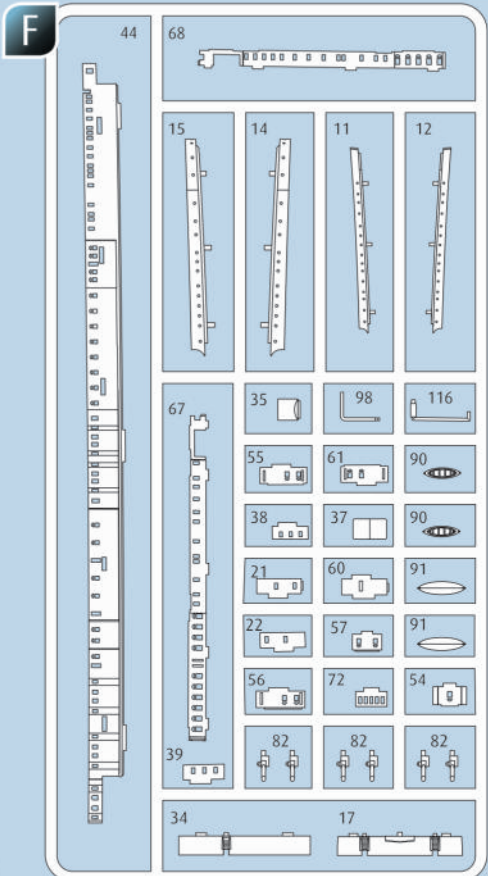
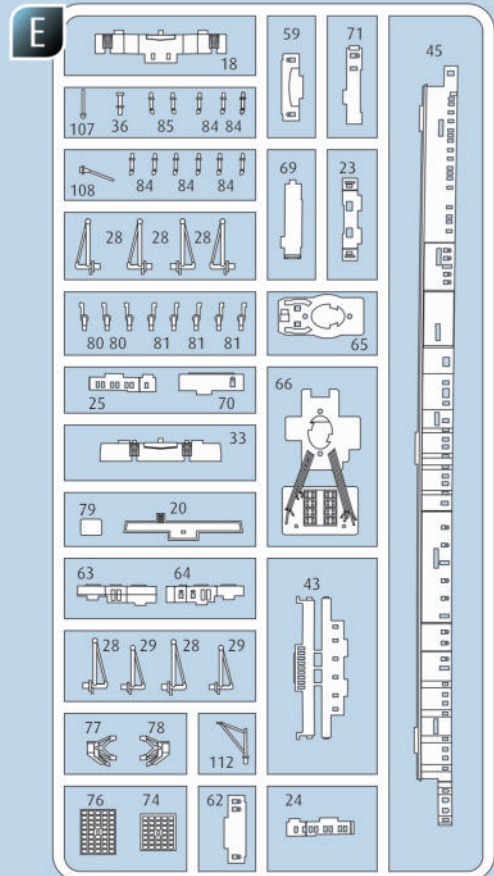
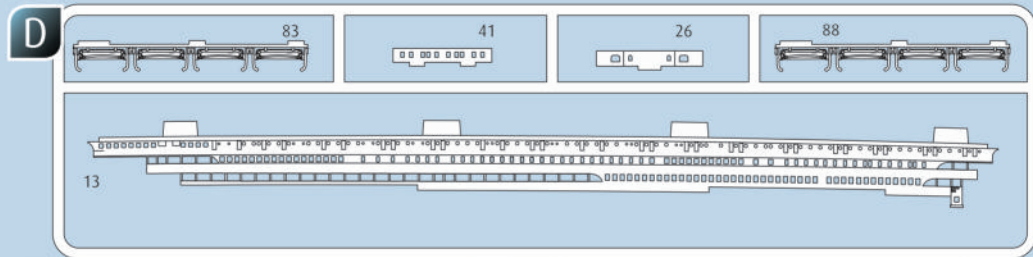
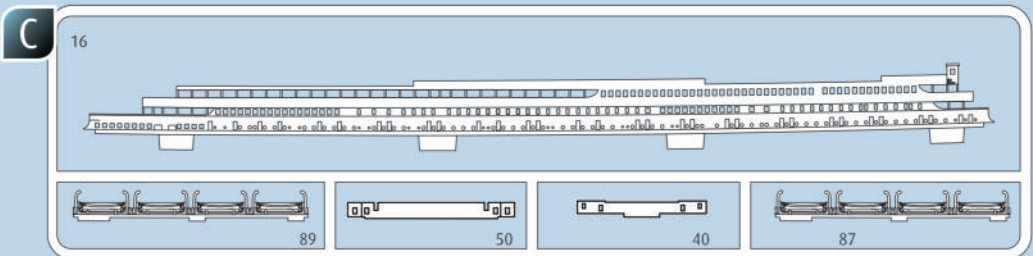



1

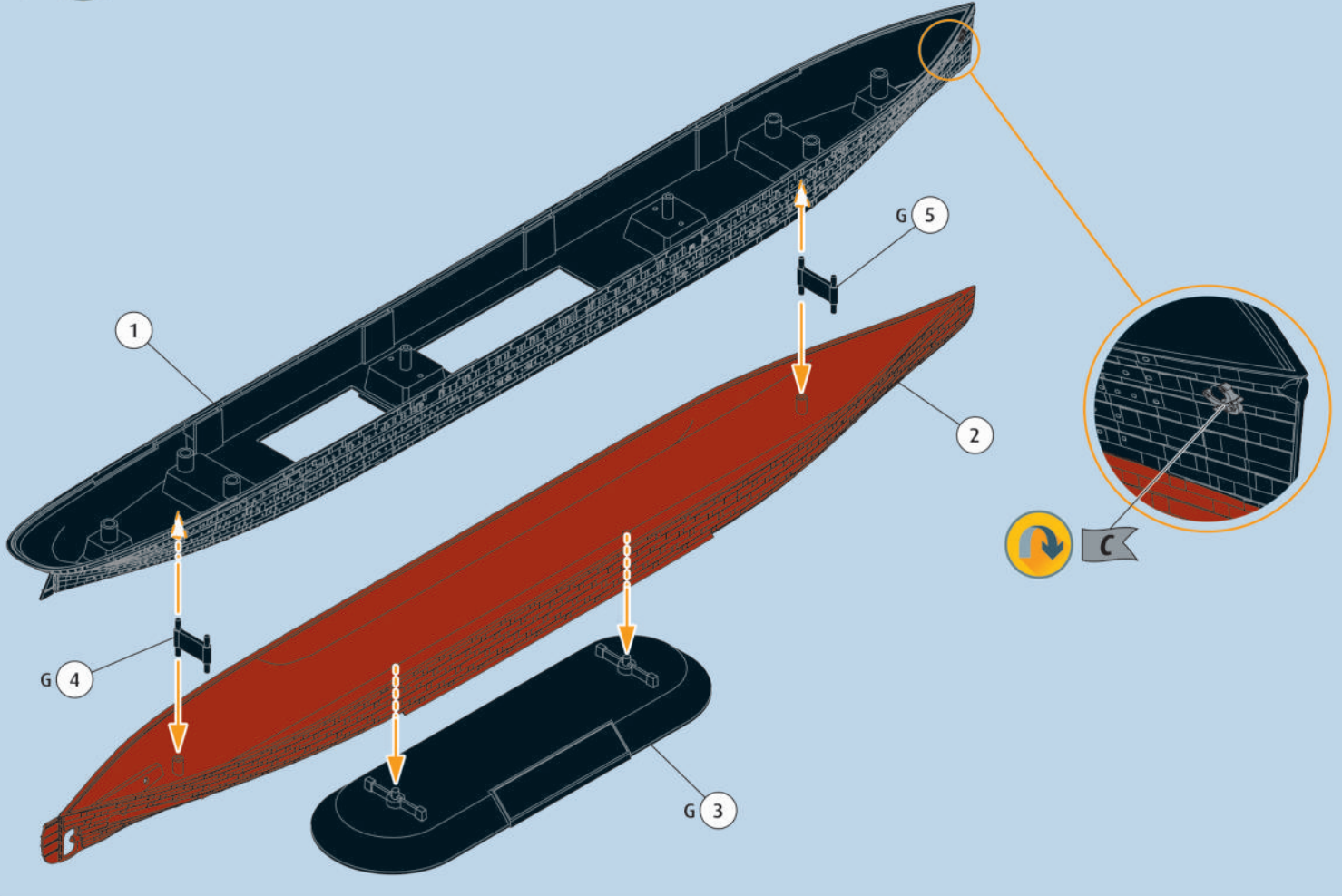

2

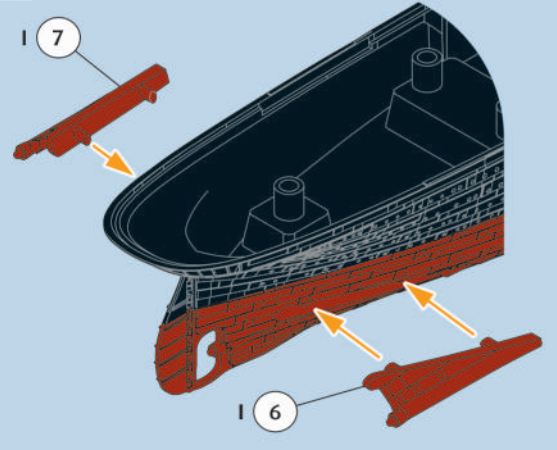

3

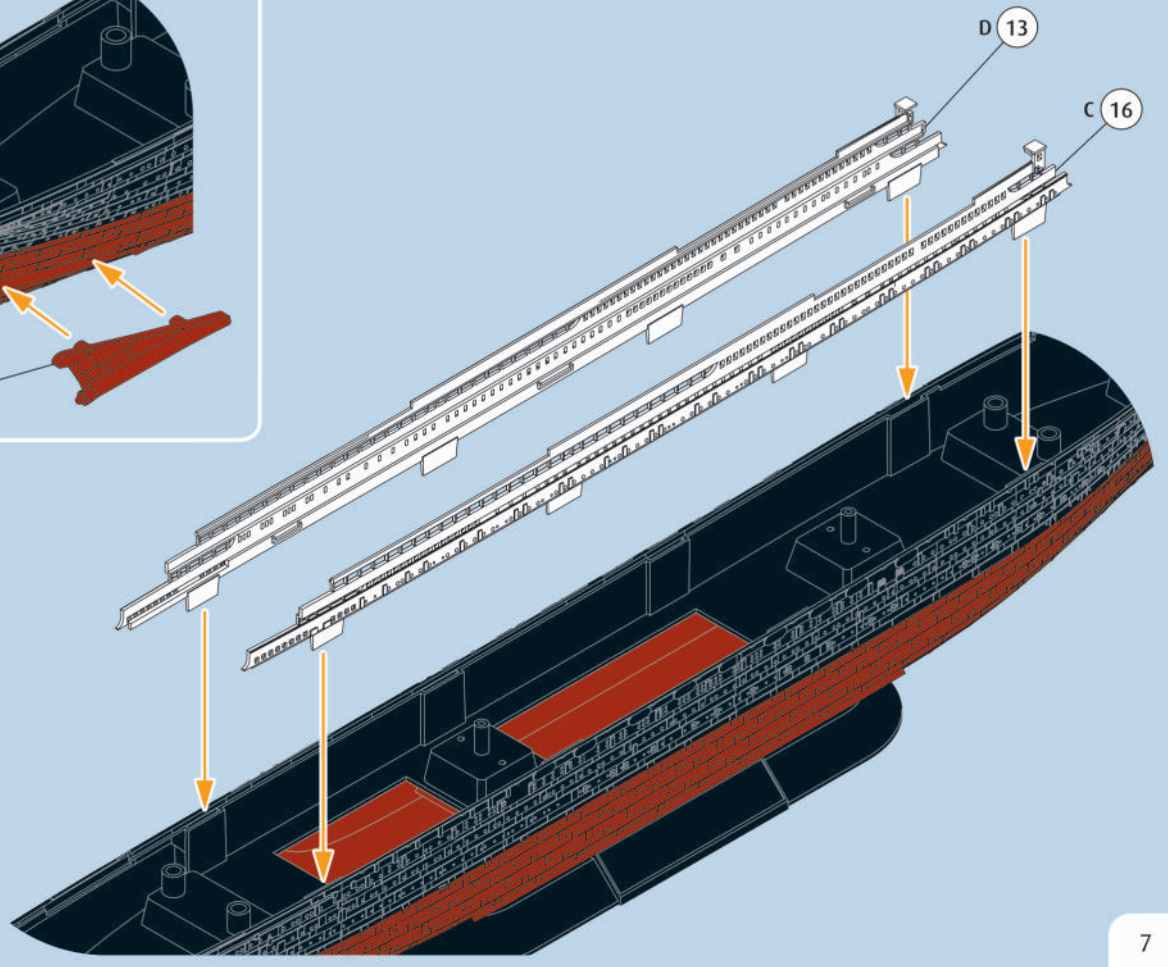

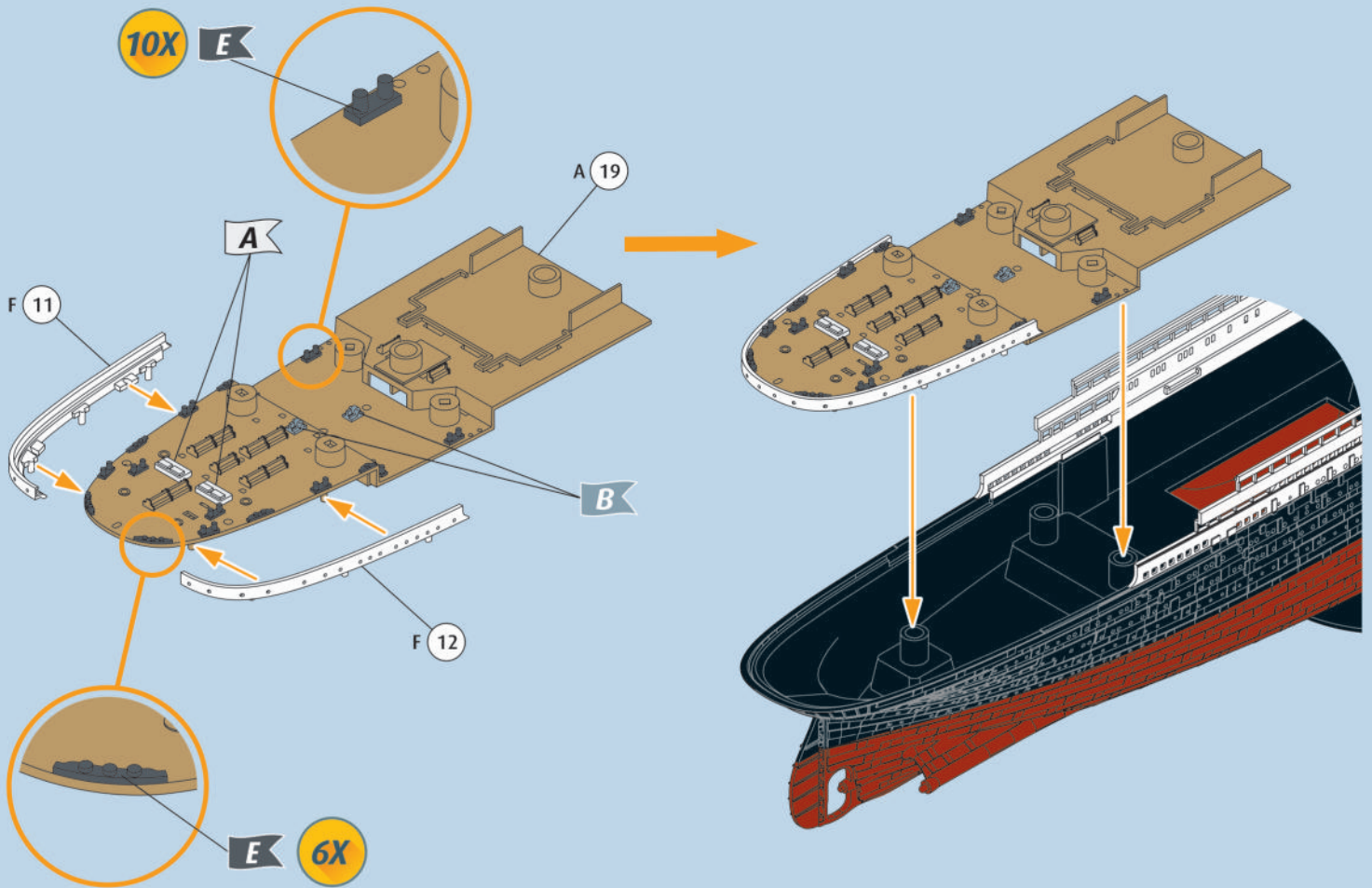

4 

5

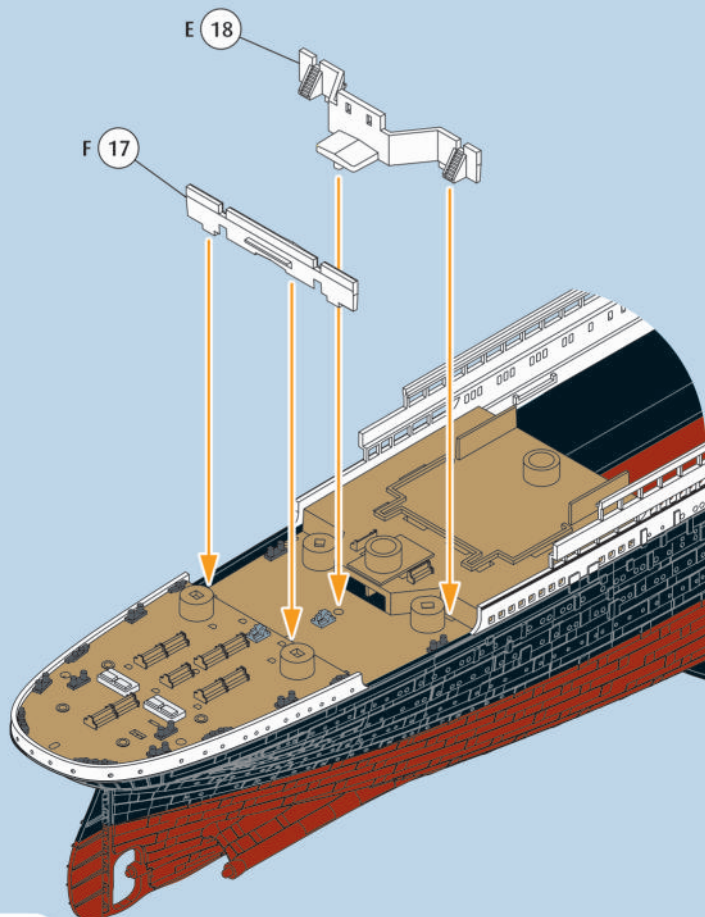
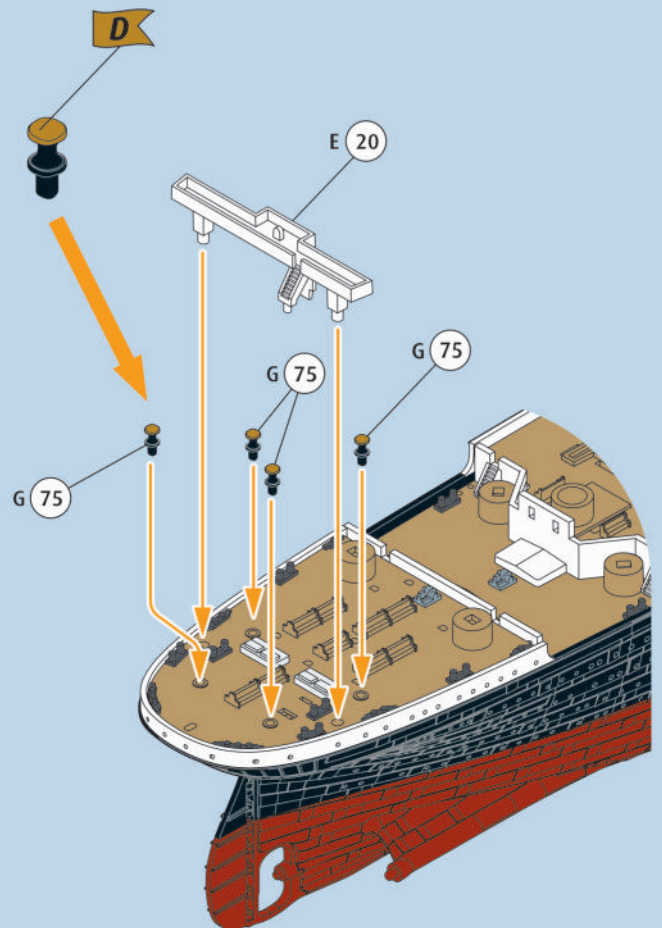
6 



7

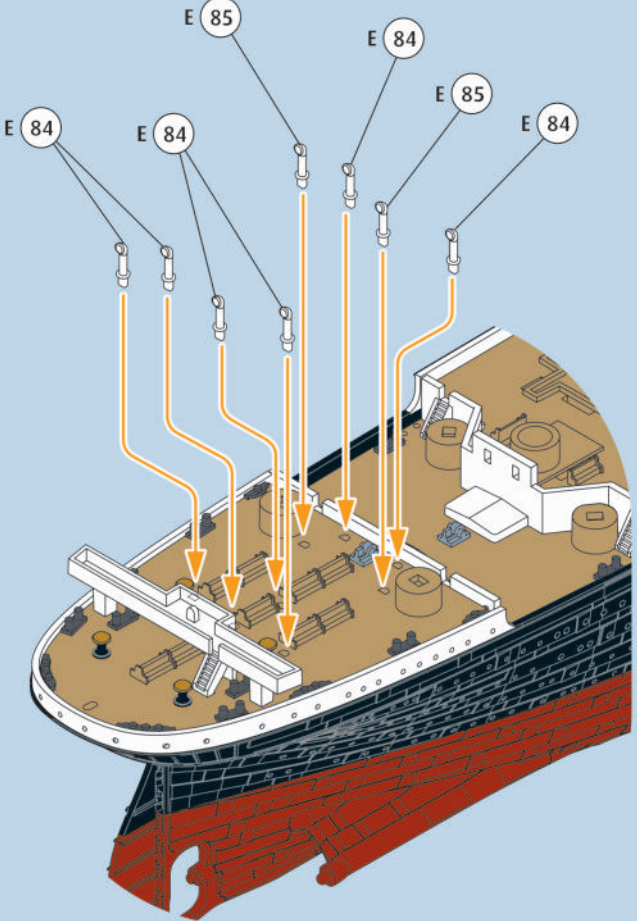

8

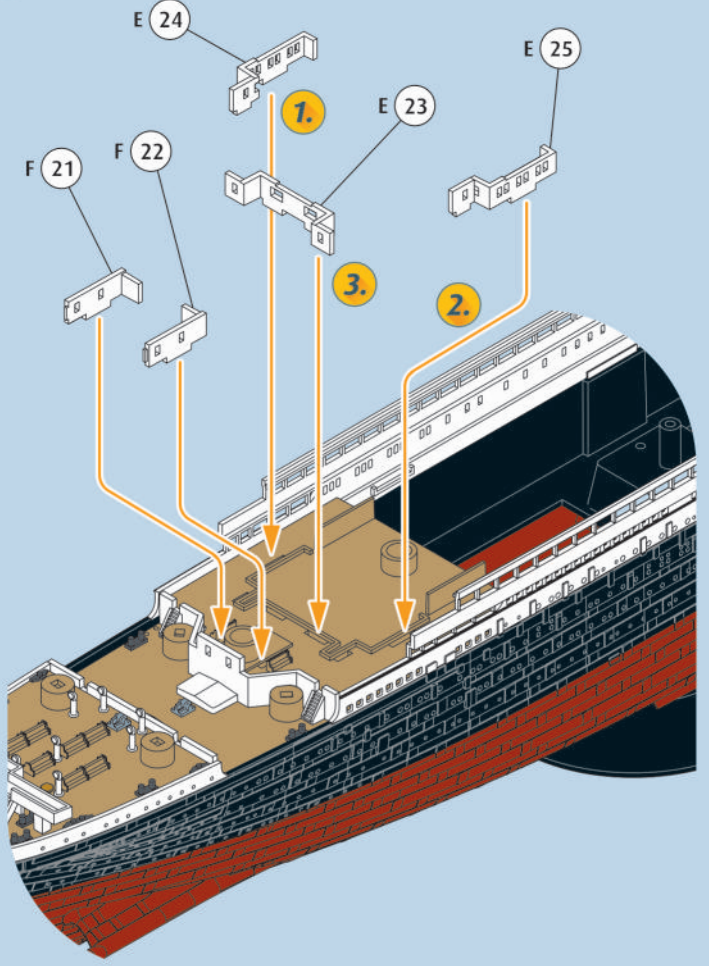

9

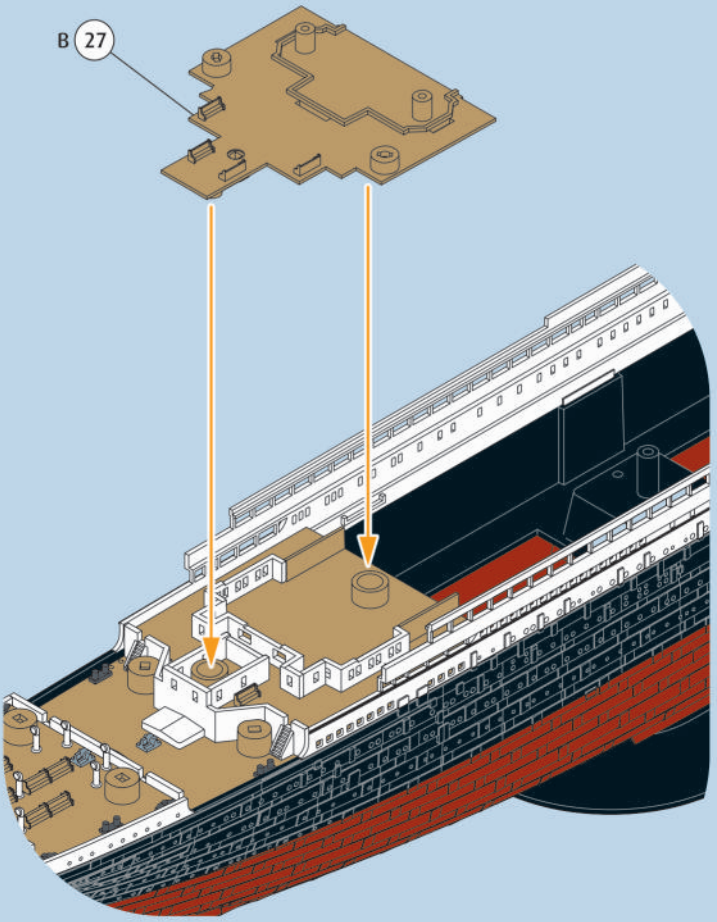

10

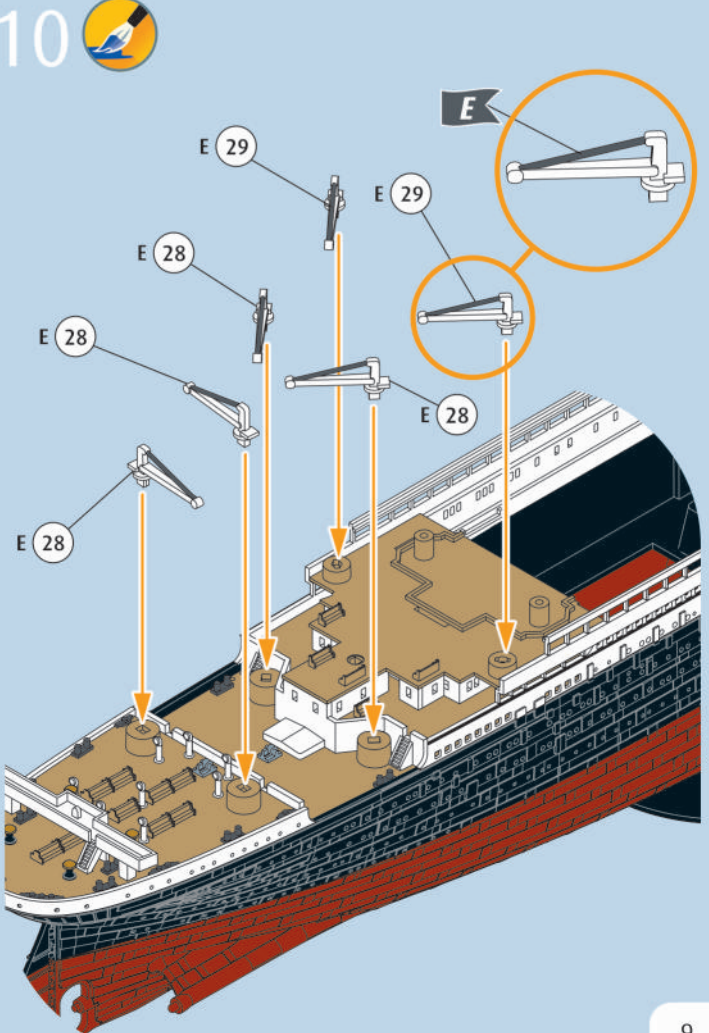



# 11

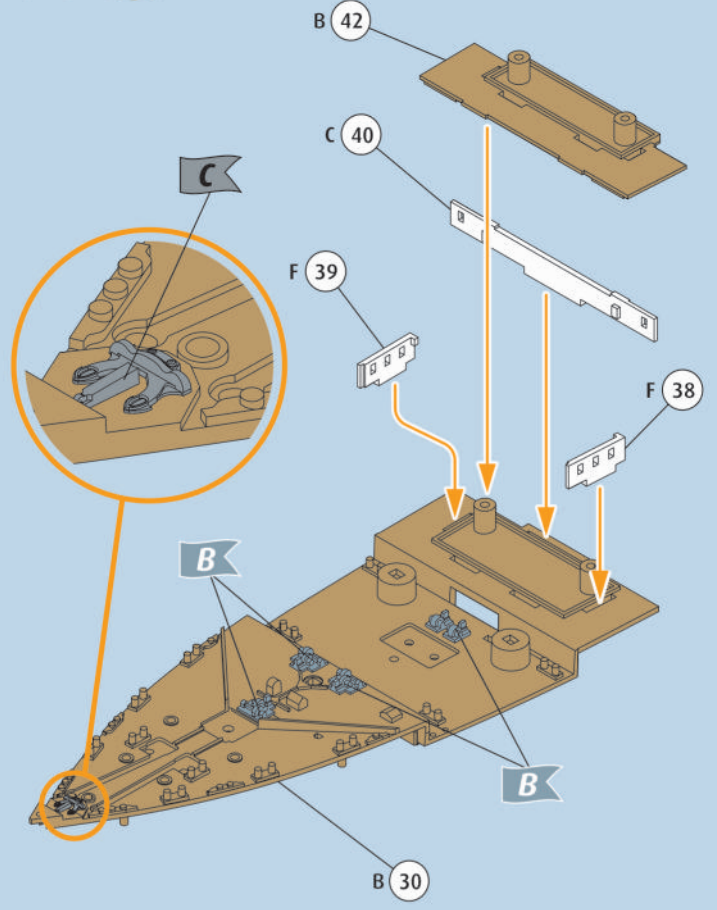

# 12

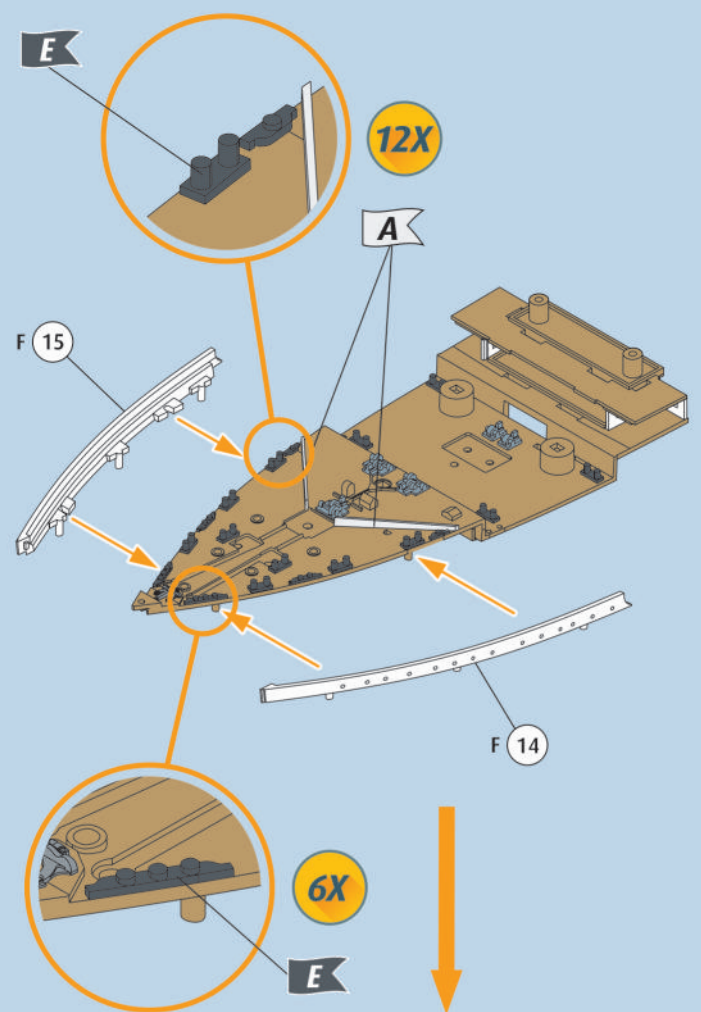

# 13

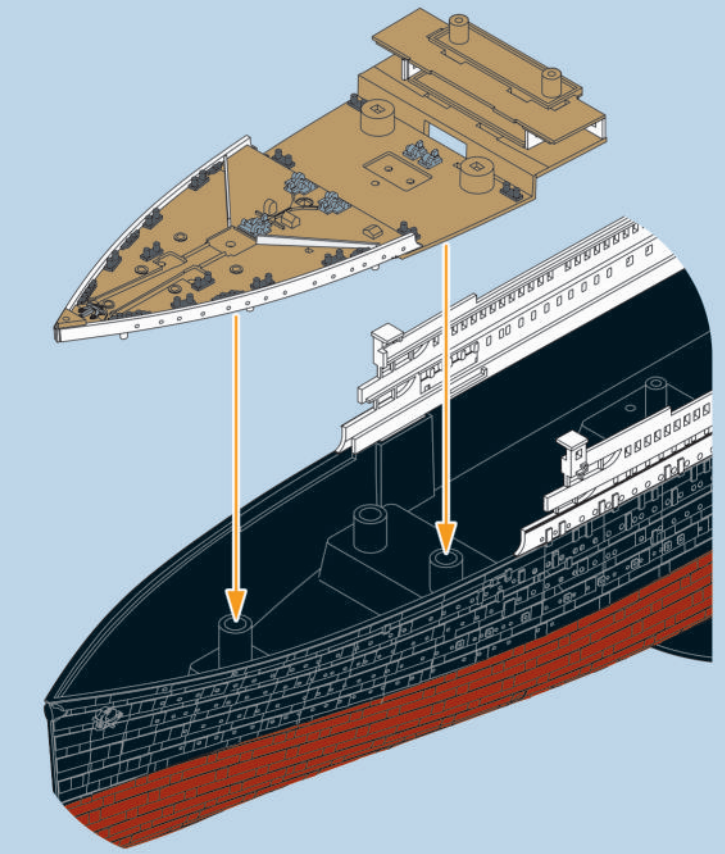
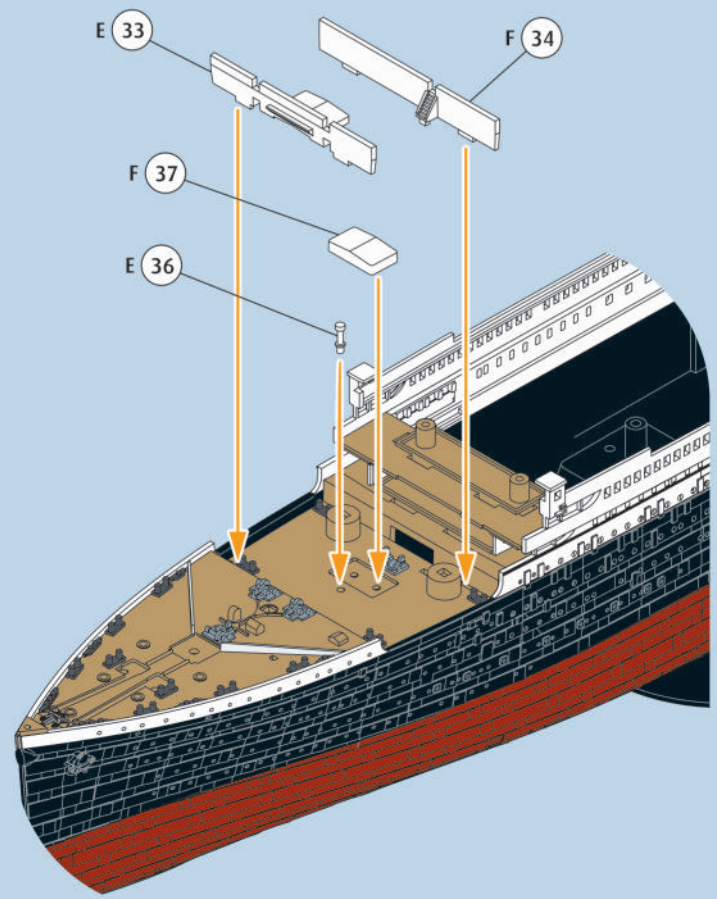



14

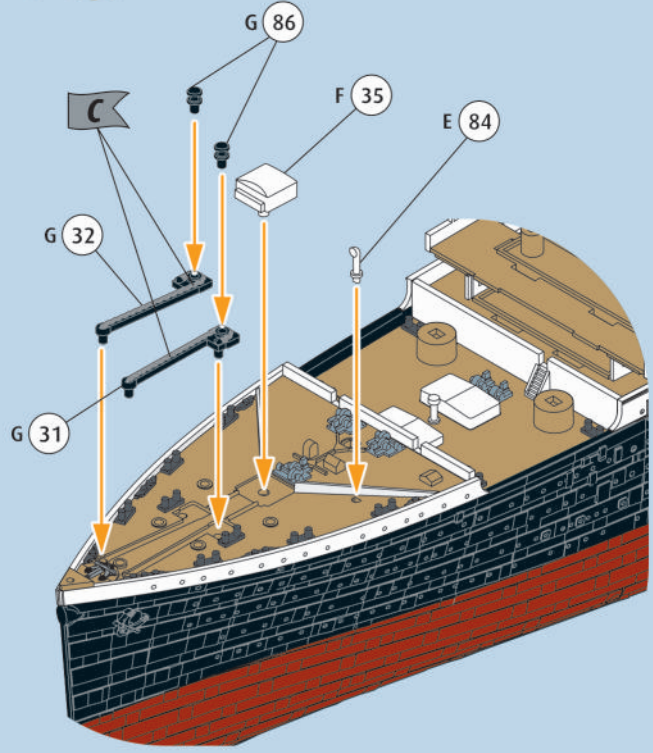

15

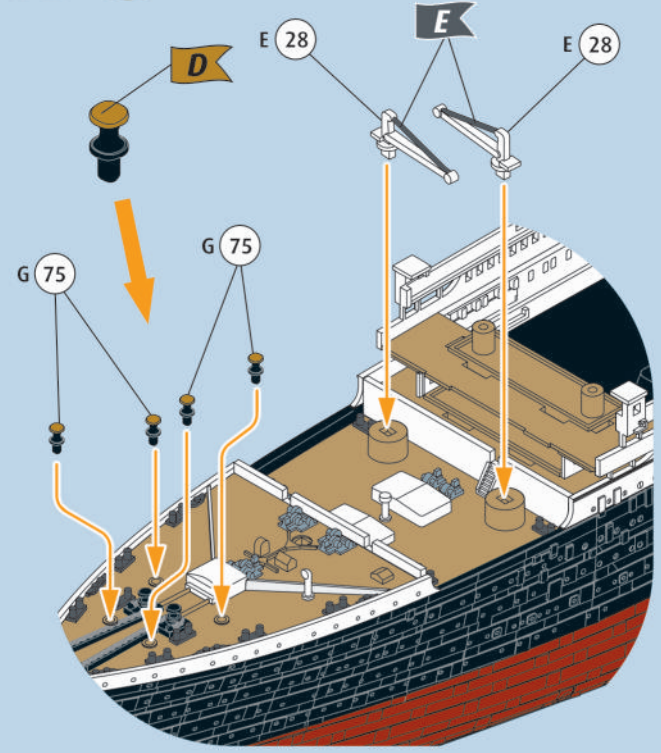

16

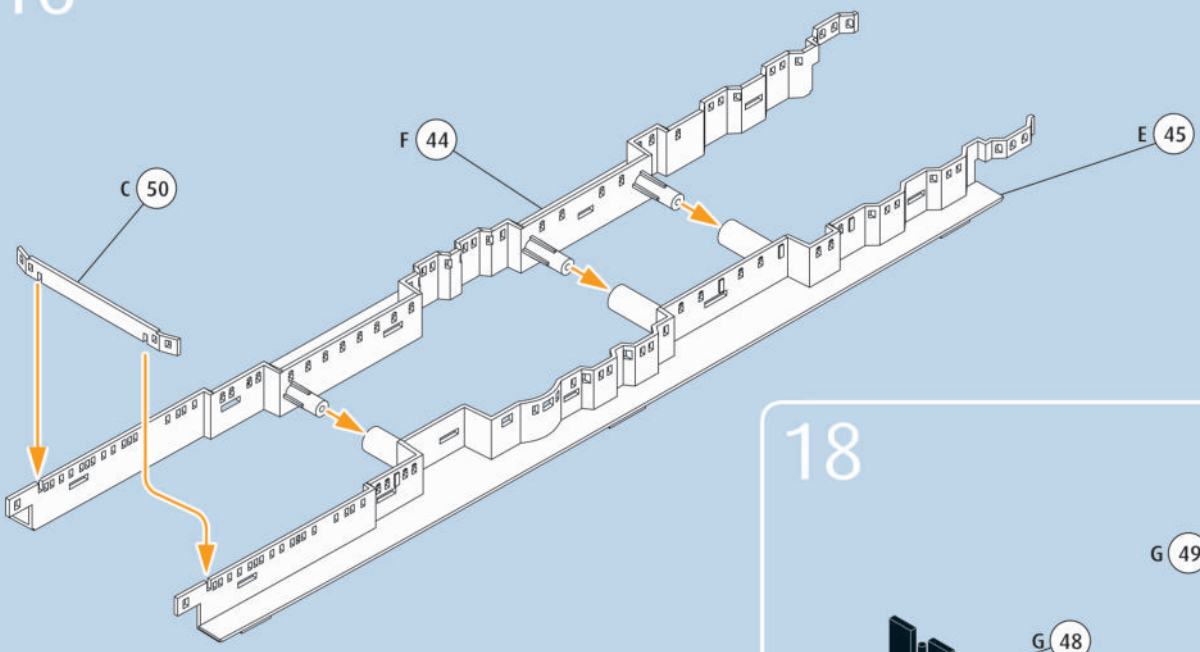

17

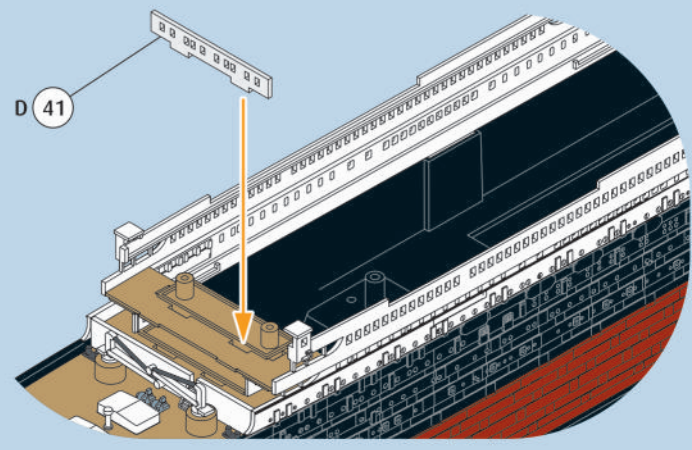

18

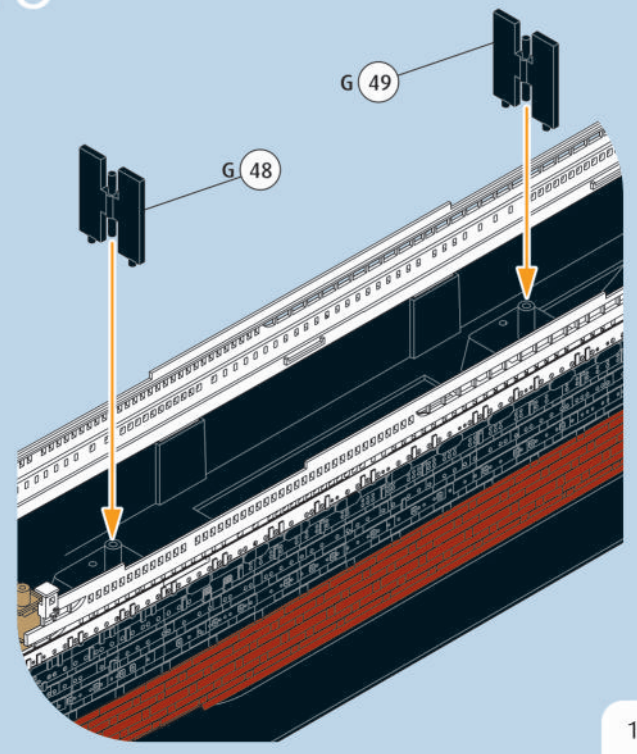



19

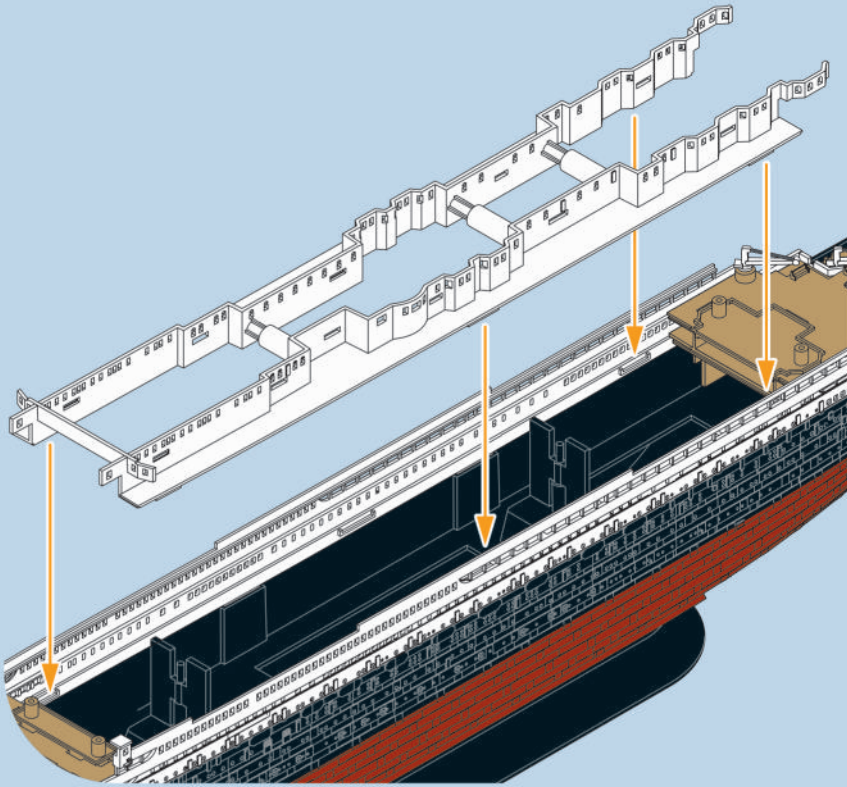

20

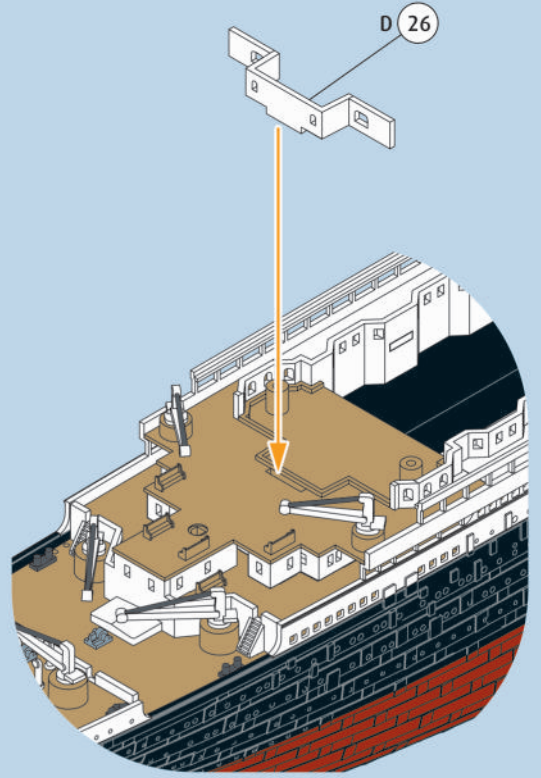

21 

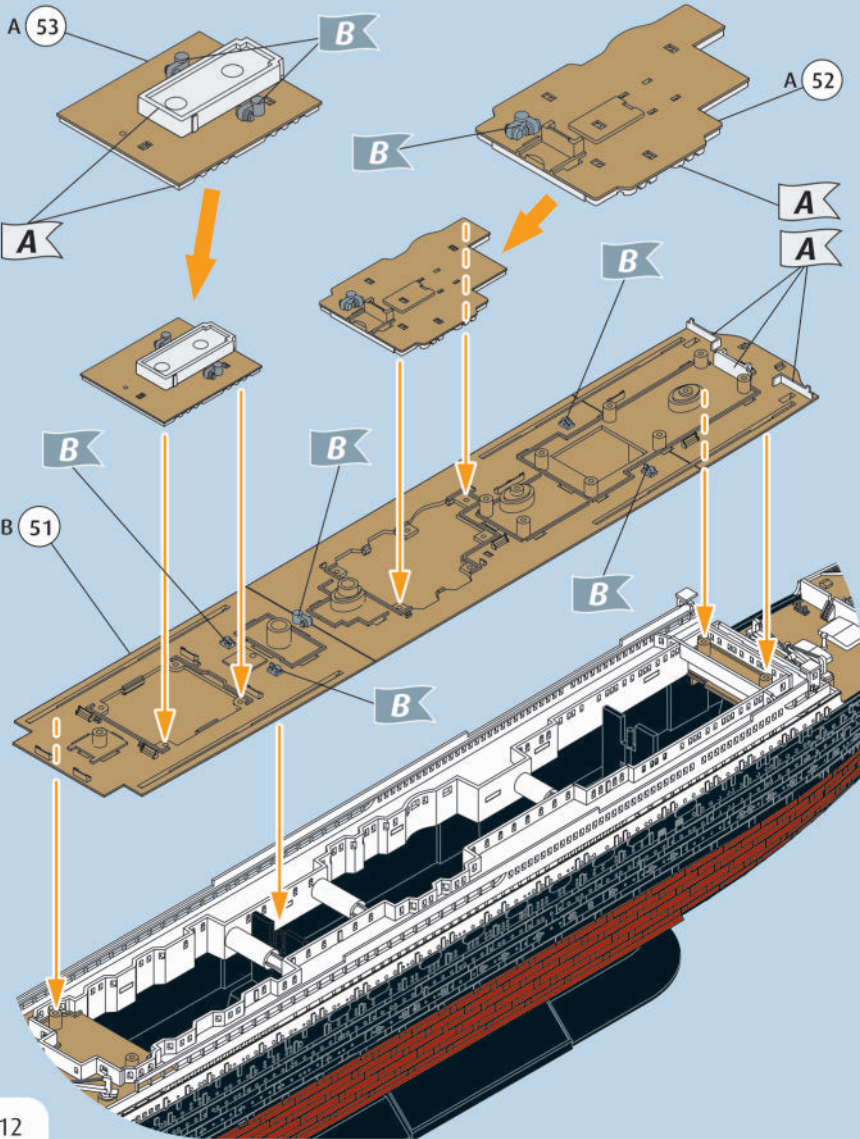

22 

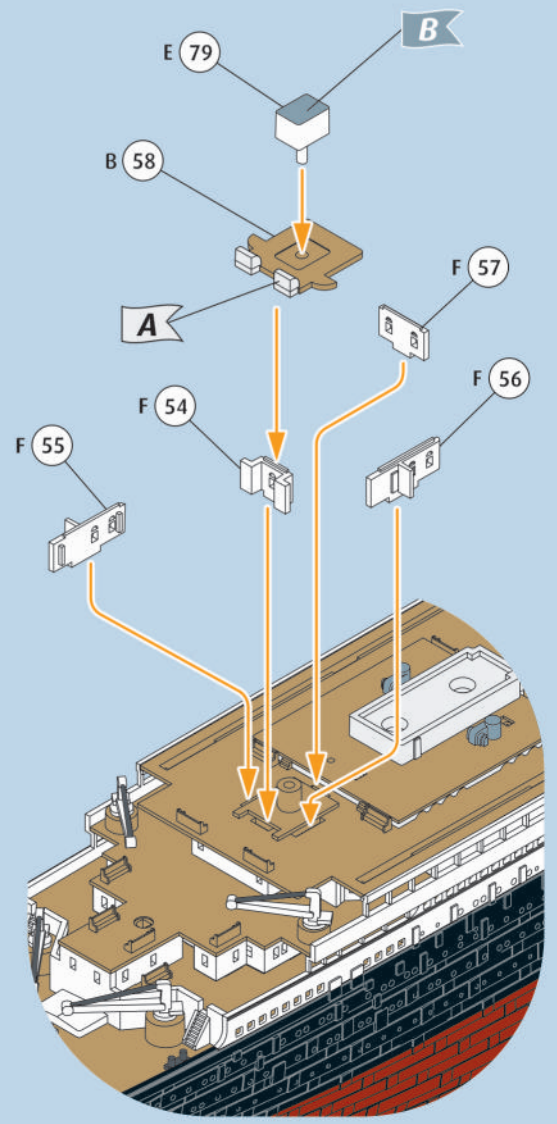



23

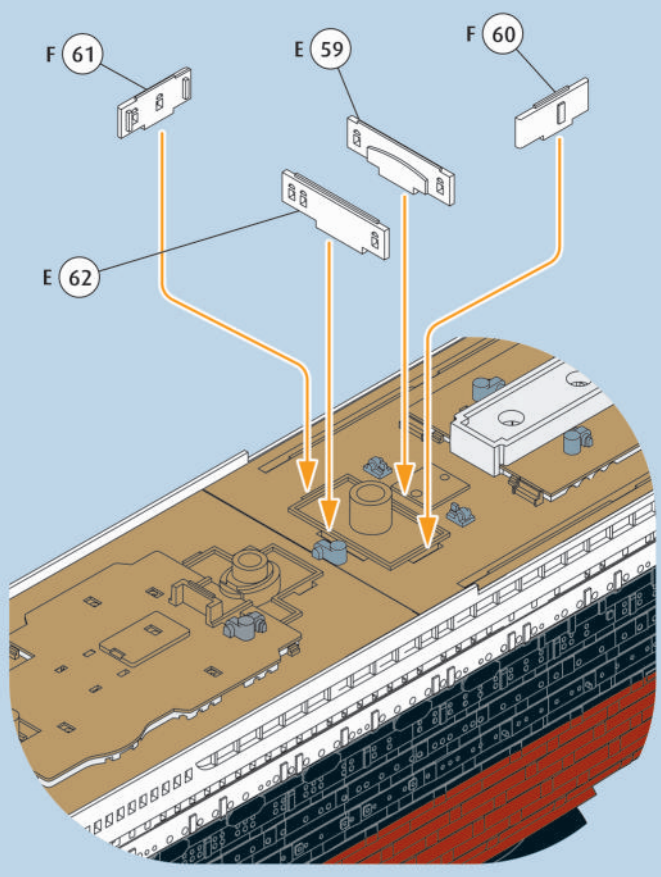

24

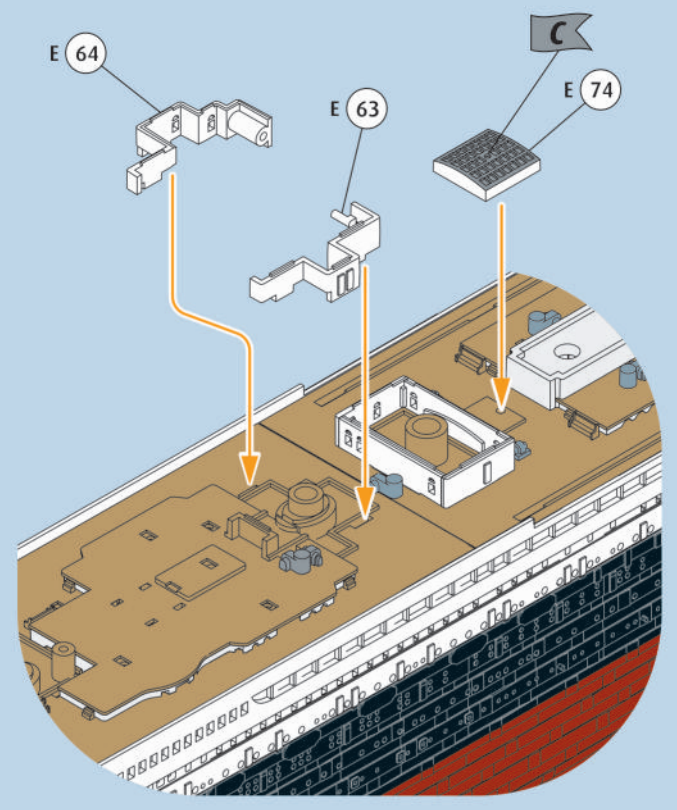

25

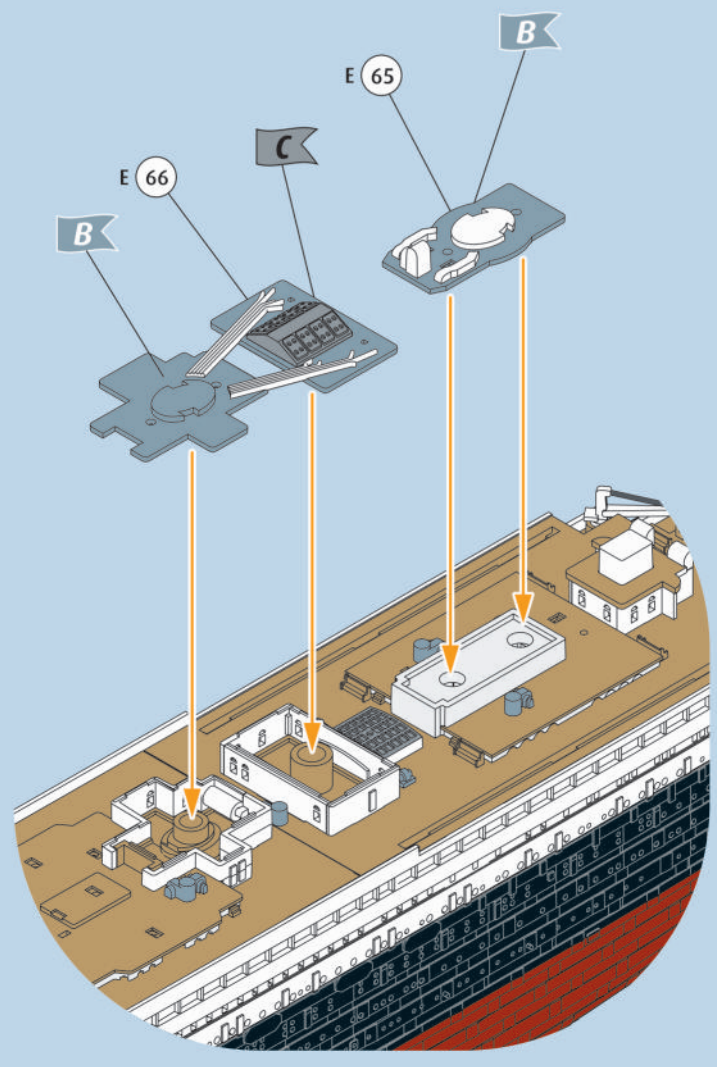

26

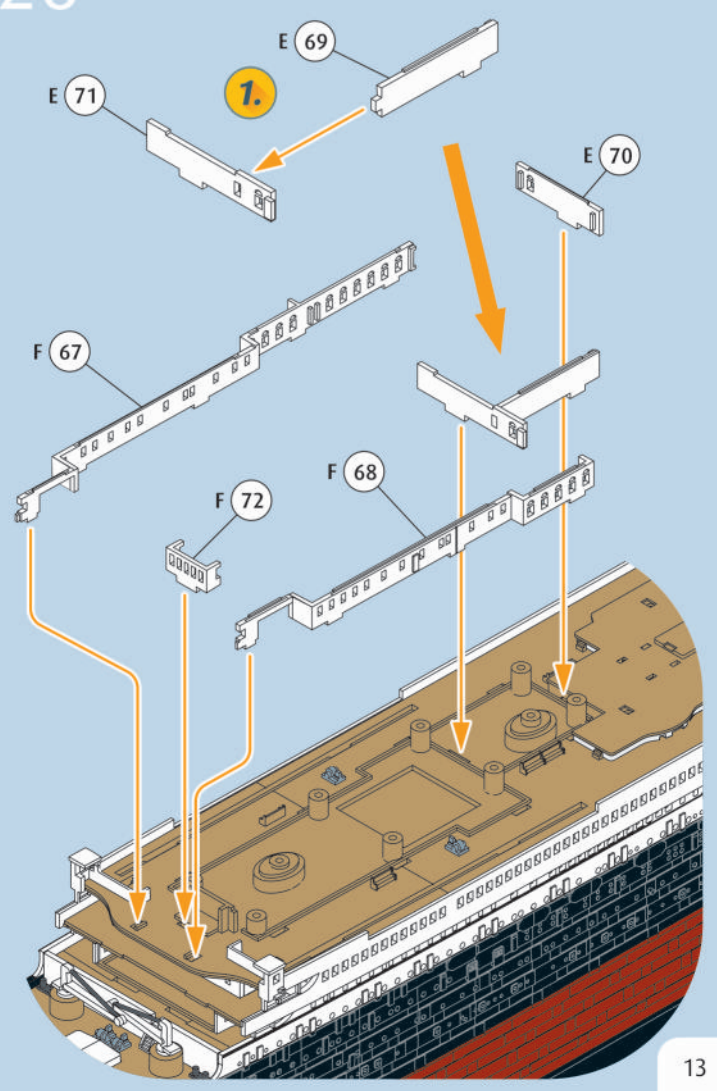

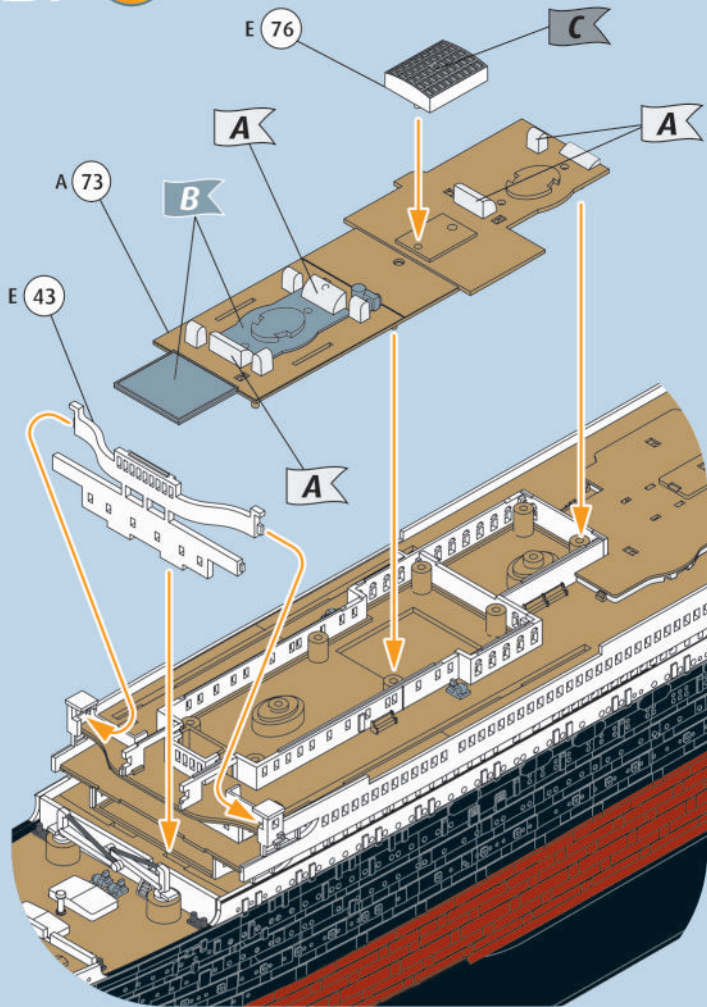

27 

28

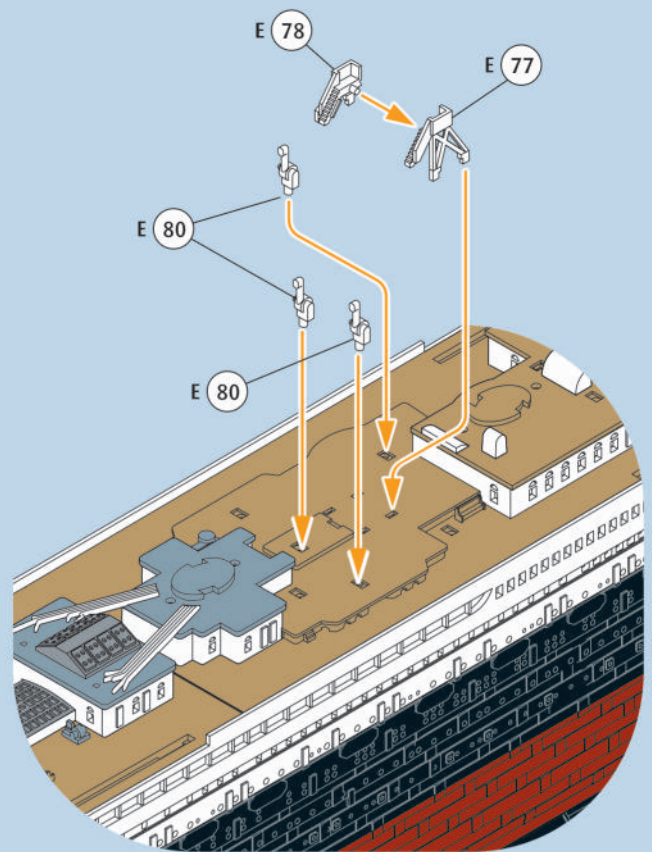

29

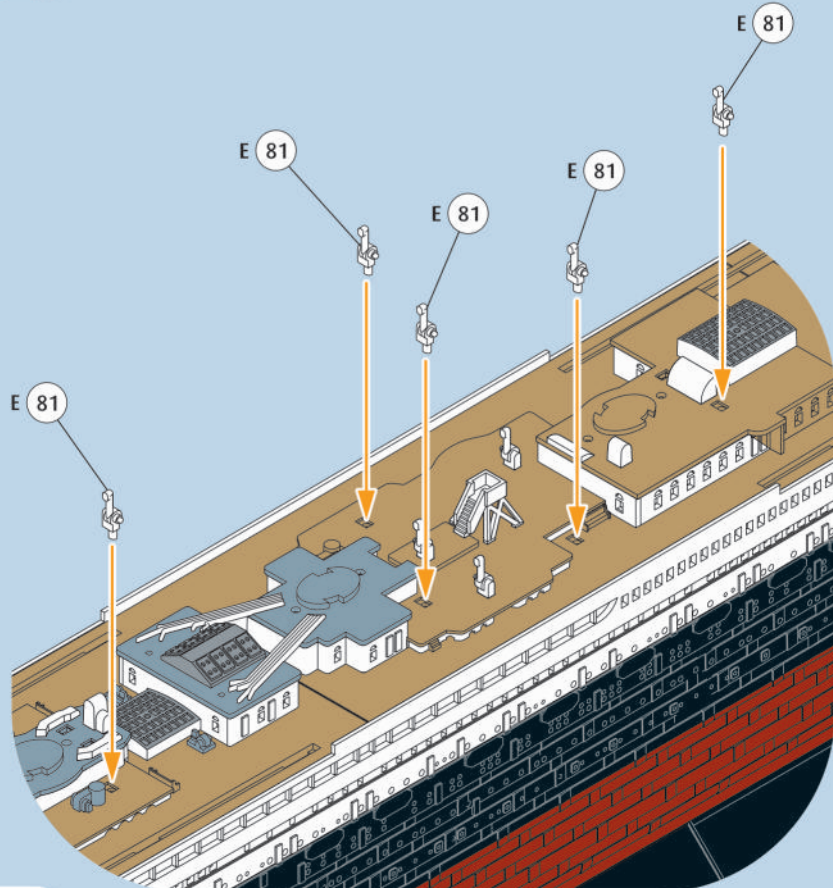

30

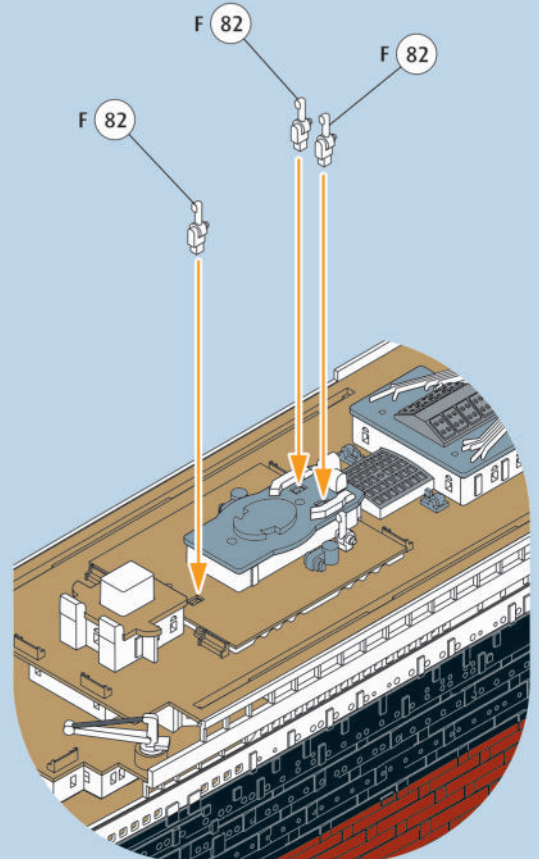



# 31

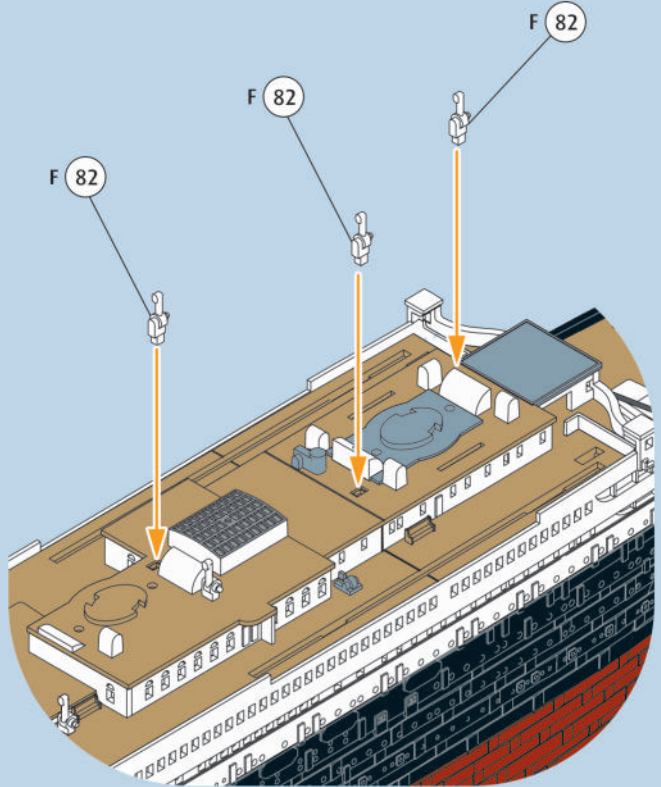

# 32

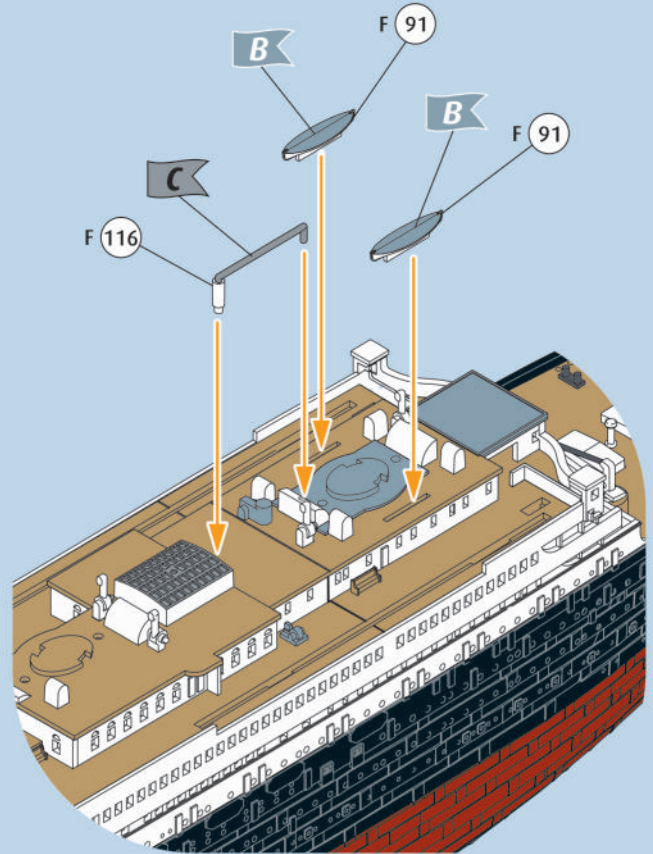

# 33

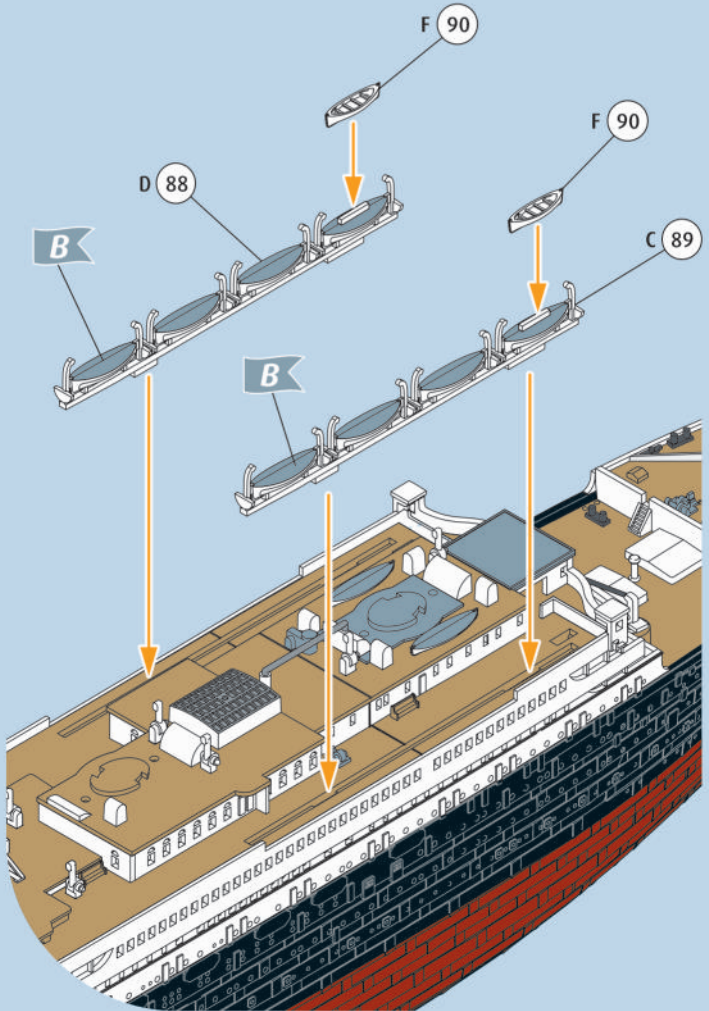

# 34

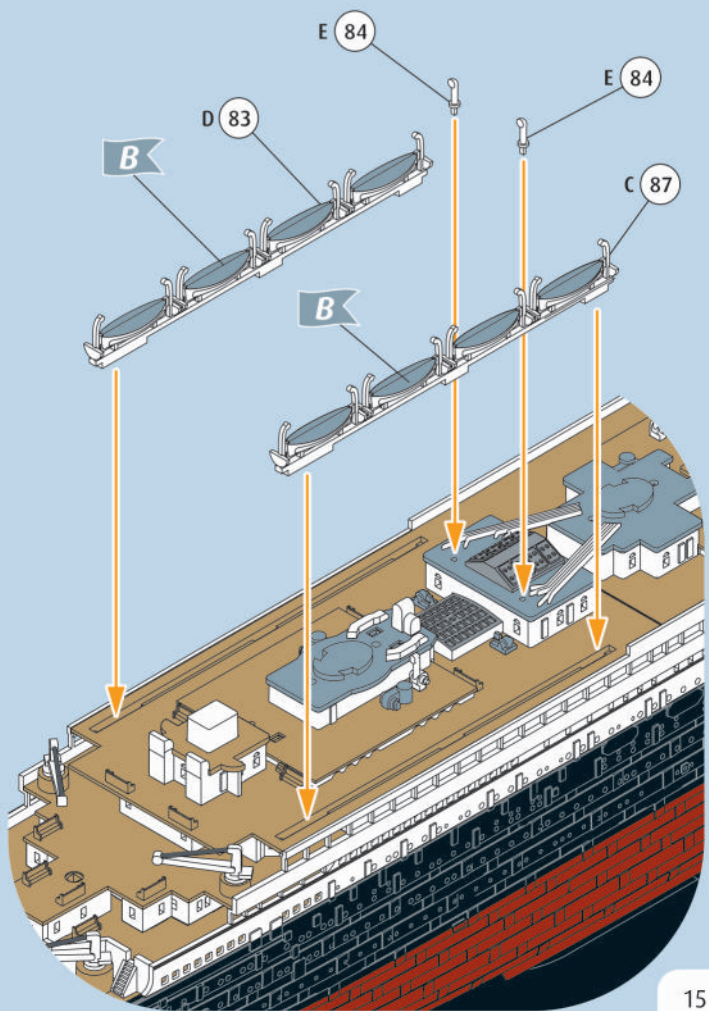



35

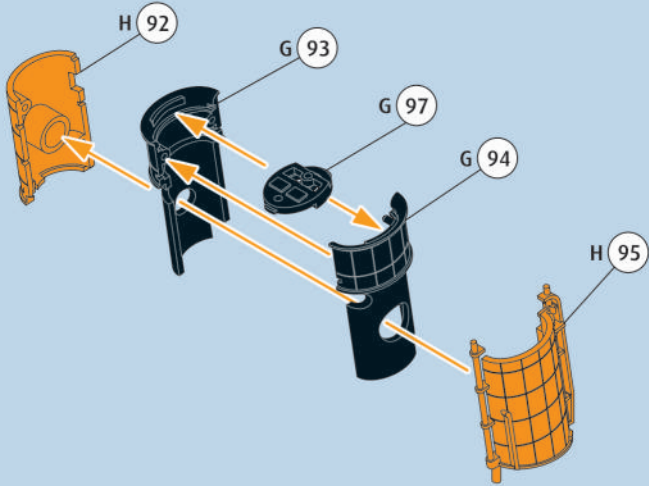

36

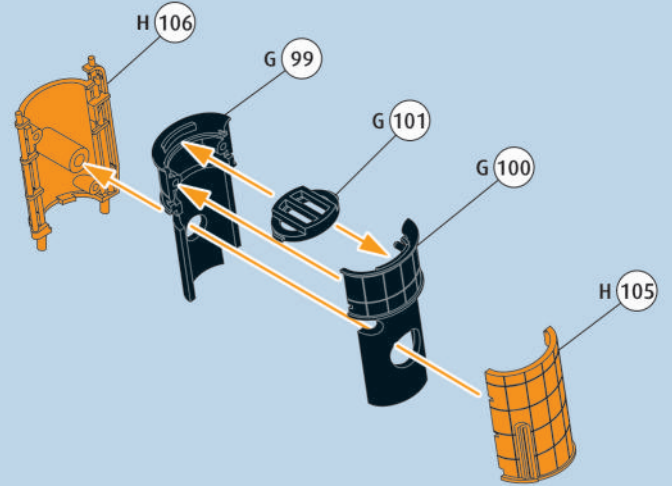

37

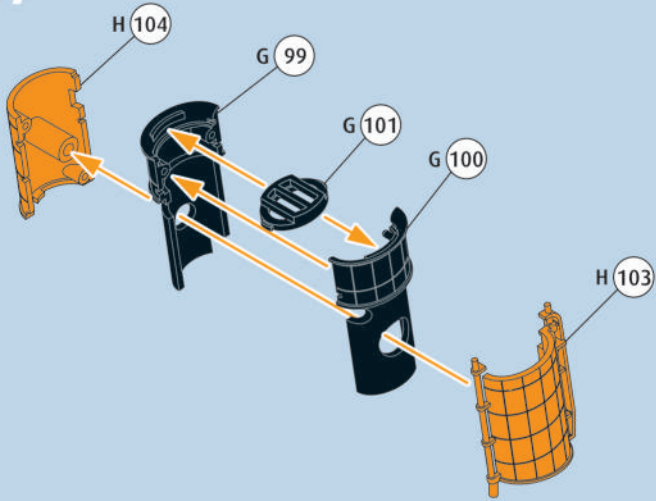

38

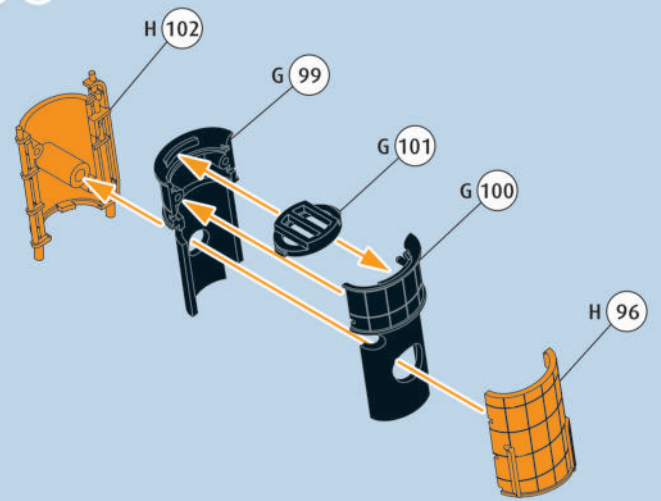

39

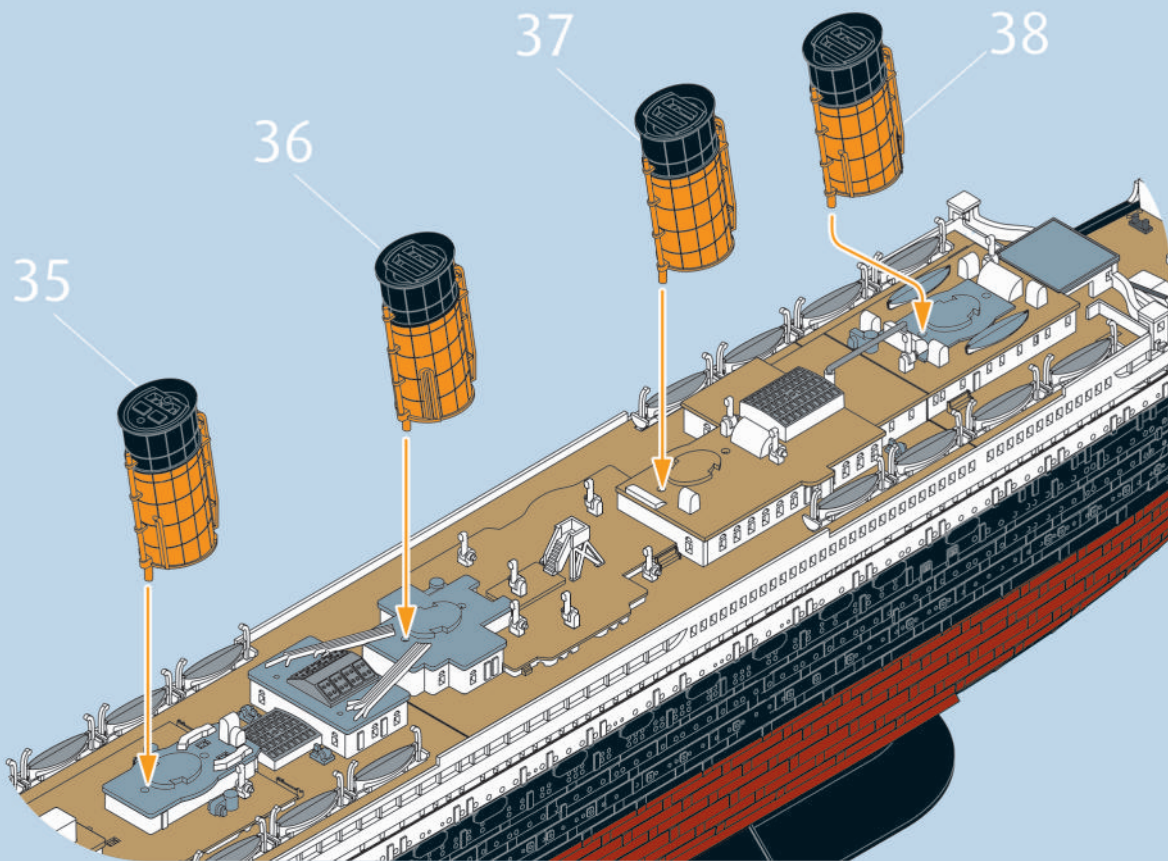



# 40

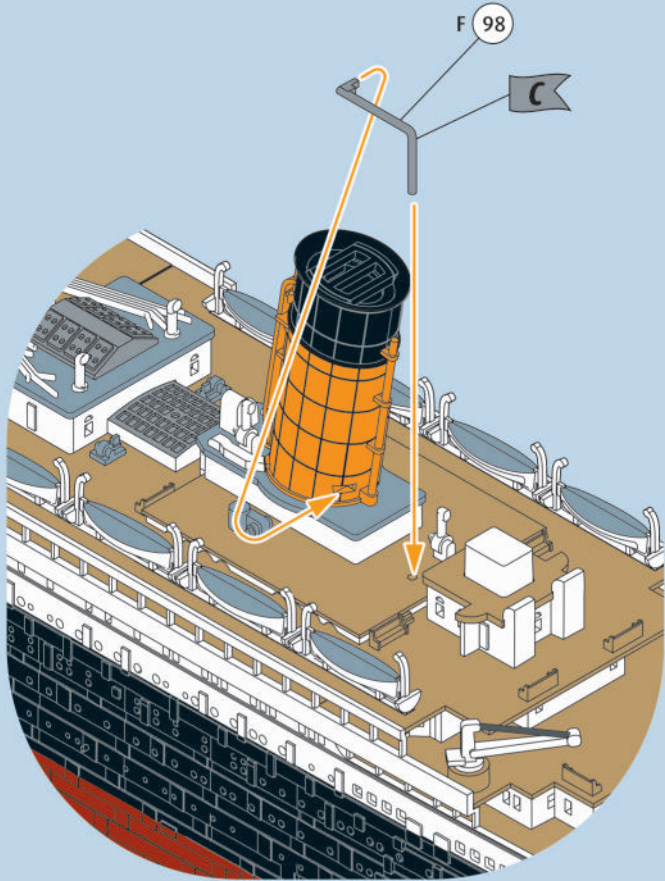

# 41

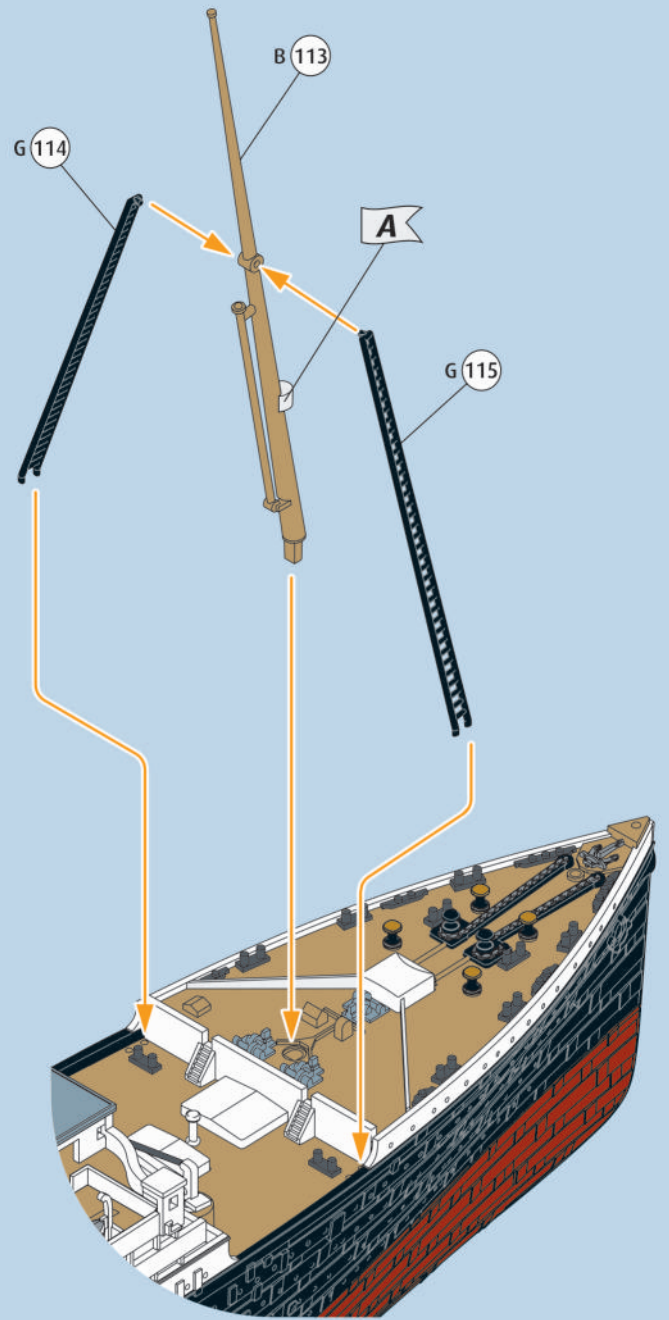

# 42

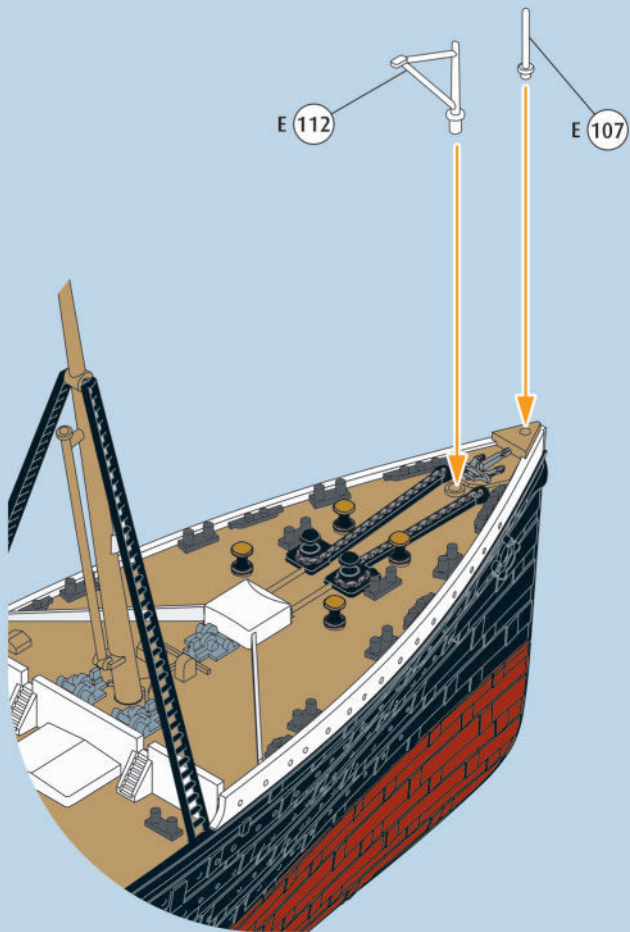



# 43

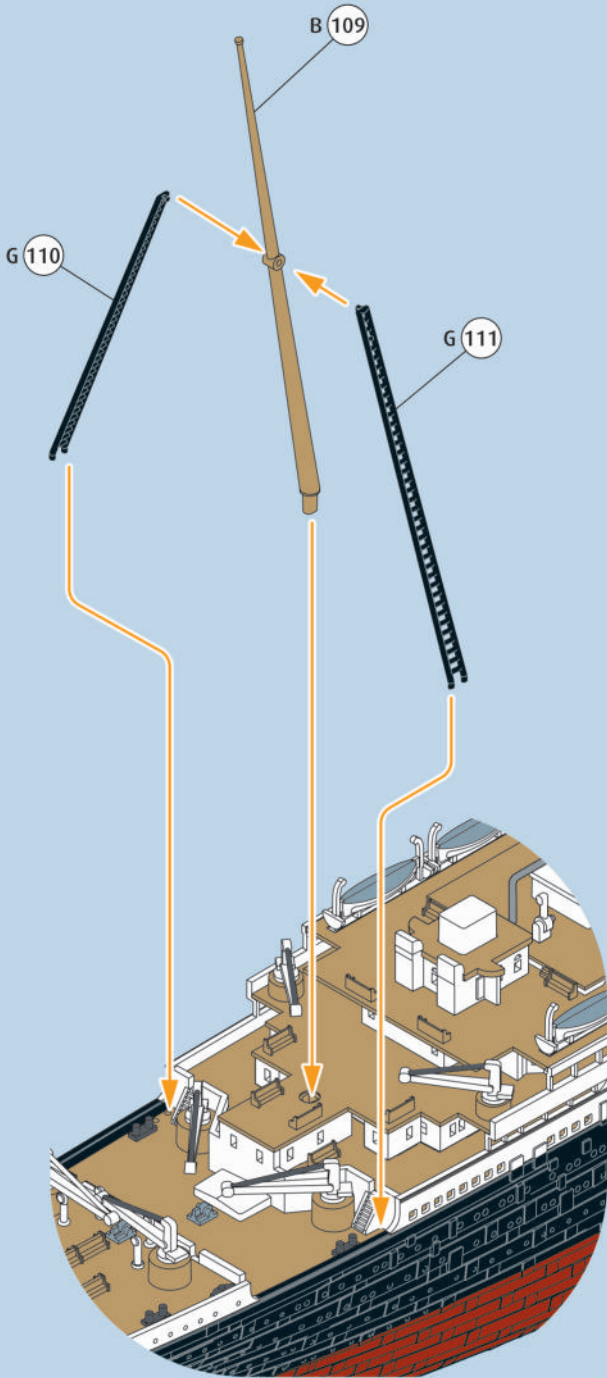

# 44

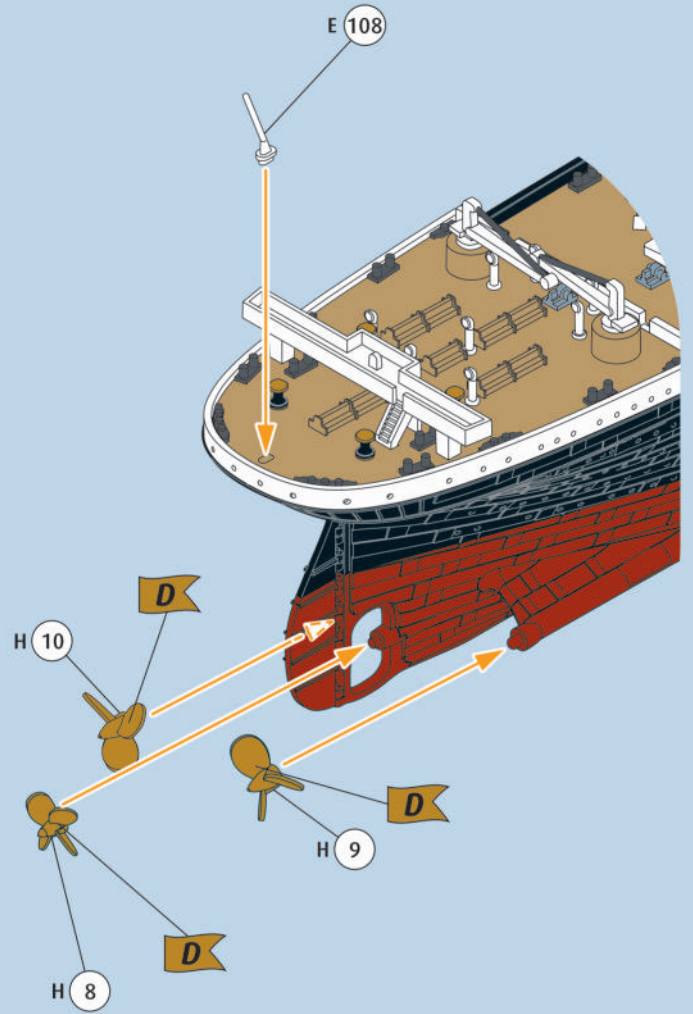





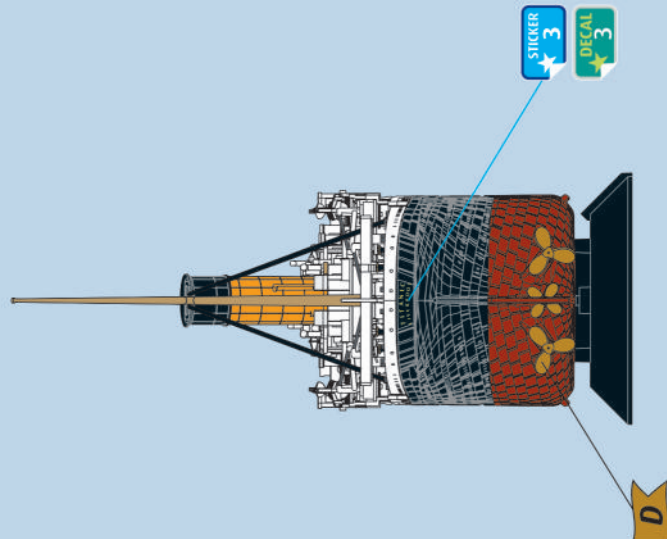
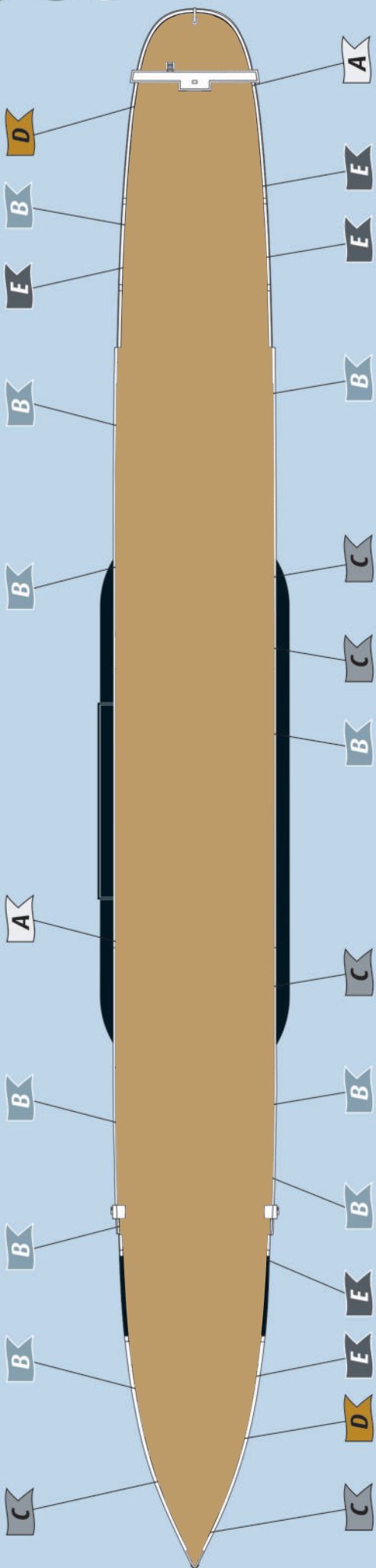

- A
- B
- C
- D
- E