



03609-0379

LEVEL 3  
1 2 3 4 5



# IMPERIAL STAR DESTROYER™

Beiliegenden Sicherheitstext beachten / Please note the enclosed safety advice

- Ⓢ Beiliegenden Sicherheitstext beachten und nachschlagbereit halten.
- Ⓢ Please note the enclosed safety advice and keep safe for later reference.
- Ⓢ Respecter les consignes de sécurité ci-jointes et les conserver à portée de main.
- Ⓢ Houdt u aan de bijgaande veiligheidsinstructies en hou deze steeds bij de hand.
- Ⓢ Seguire le avvertenze di sicurezza allegate e tenerle a portata di mano.
- Ⓢ Observar y siempre tener a disposición este texto de seguridad adjunto.
- Ⓢ Ter em atenção o texto de segurança anexo e guardá-lo para consulta.

- Ⓢ Overhold vedlagte sikkerhedsanvisninger og hav dem liggende i nærheden.
- Ⓢ Ha alltid vedlagt sikkerhetstext klar til bruk.
- Ⓢ Beakta bifogad säkerhetstext och håll den i beredskap.
- Ⓢ Huomioi ja säilytä oheiset varoitukset.
- Ⓢ Соблюдать технику безопасности, сохранить инструкцию для дальнейших обращений.
- Ⓢ Przestrzegać załączonego tekstu dotyczącego bezpieczeństwa i mieć go zawsze pod ręką.
- Ⓢ Dodržujte tento priložený bezpečnostní text a mějte ho po ruce.
- Ⓢ A mellékelt biztonsági szöveget vegye figyelembe és tartsa fellepozásra készen.

- Ⓢ Respektujte priložený bezpečnostný text a uchovajte ho pre budúce použitie.
- Ⓢ Respectați textul de siguranță atașat și păstrați-l la îndemână.
- Ⓢ Спазвайте приложения текст за безопасност и го дръжте под ръка за справки.
- Ⓢ Prilolena varnostna navodila izvajajte in jih hranite na vsem dostopnem mestu.
- Ⓢ Λάβετε υπόψη σας το συννημένο κείμενο ασφαλείας και φυλάξτε το ώστε να ανατρέχετε σε αυτό όποτε χρειάζεται.
- Ⓢ Ektekigüvenlik talimatlarını dikkate alıp, bakabileceğiniz bir şekilde muafaza ediniz.





☞ Weitere Tipps und Tricks.  
 ☞ Additional tips and tricks.  
 ☞ Conseils et astuces supplémentaires.  
 ☞ Andere tips en trucs.  
 ☞ Ulteriori consigli e suggerimenti.  
 ☞ Consejos y sugerencias adicionales.  
 ☞ Mais dicas e truques.

☞ Flere tips og tricks.  
 ☞ Flere tips og tricks.  
 ☞ Ytterligare tips och tricks.  
 ☞ Lisää vinkkejä ja niksejä.  
 ☞ Другие советы и хитрости.  
 ☞ Dalsze wskazówki i sugestie.  
 ☞ Další tipy a rady.  
 ☞ További ötletek és fogások.  
 ☞ Dalsie tipy a triky.  
 ☞ Alte sfaturi și trucuri.

☞ Други полезни съвети и трикове.  
 ☞ Nadaljnji nasveti in zvižaje.  
 ☞ Πρόσθετες συμβουλές και κόλπα.  
 ☞ Diğer öneriler ve ipuçları.

www.revell.de



- DE Kleben
- GB Glue
- FR Collier
- NL Lijmen
- IT Incollare
- ES Pegamento
- PT Colar
- DK Lim
- NO Lime
- SE Limma
- FI Liimaa
- RU Клеить
- PL Przykleić
- CZ Slepění
- HU Ragassza rá
- SK Lepiť
- NO Lipiti
- GB Залепете
- SI Prilepite
- GR ΚΟΛΛΗΣΤΕ
- TR Yapıştırma



- DE Nicht kleben
- GB Don't glue
- FR Ne pas coller
- NL Niet lijmen
- IT Non incollare
- ES No pegamento
- PT Não colar
- DK Lim ikke
- NO Ikke lime
- SE Limma inte
- FI Älä liimaa
- RU Не клеить
- PL Nie przyklejać
- CZ Nelepít
- HU Ne ragassza rá
- SK Nelepít
- NO Nu lipiti
- GB Не лепете
- SI Ne lepíte
- GR Μην κολλήσετε
- TR Yapıştırmayın



- DE Bemalen
- GB Paint
- FR Peindre
- NL Beschilderen
- IT Colorare
- ES Pintar
- PT Pintar
- DK Mal
- NO Male
- SE Måla
- FI Maalaa
- RU Раскрасить
- PL Pomalować
- CZ Pomalovat
- HU Fesse be
- SK Natrief
- NO Vopsiñt
- GB Боядисајте
- SI Robarvajte
- GR Βάψτε
- TR Boyama



- DE Zusammenbau Reihenfolge.
- GB Sequence of assembly.
- FR Ordre d'assemblage.
- NL Volgorde van montage.
- IT Sequenza di assemblaggio.
- ES Secuencia de montaje.
- PT Sequência de montagem.
- DK Samlerækkefølge.
- NO Monteringsrekkefølge.
- SE Monteringsordningsföljd.
- FI Kokoamisjärjestys.
- RU Последовательность сборки.
- PL Kolejność montażu.
- CZ Pořadí složení.
- HU Összerakási sorrend.
- SK Poradie zostavenia.
- NO Ordinea asamblării.
- GB Последовательность на сглобяване.
- SI Vrstni red sestavljanja.
- GR Σειρά τοποθέτησης.
- TR Parçaları birleştirme sırası.



- DE Bauteile trocknen lassen.
- GB Allow the parts to dry.
- FR Laisser sécher les pièces.
- NL Ouderdelen laten drogen.
- IT Lasciare asciugare i componenti.
- ES Dejar secar las piezas.
- PT Deixar as peças secar.
- DK Lad delene tørre.
- NO Tørk komponenter.
- SE Låt komponenterna torka.
- FI Anna rakenneosien kuivua.
- RU Дайте деталям высохнуть.
- PL Pozostawić elementy konstrukcji do wyschnięcia.
- CZ Nechte díly uschnout.
- HU Hagyja megszáradni az alkatrészeket.
- SK Konštrukčné diely nechajte vyschnúť.
- NO Låsađi componentele să se usuce.
- GB Оставете сглобените части да изсъхнат.
- SI Osušite sestavne dele.
- GR Αφήστε τα μέρη να στεγνώσουν.
- TR Yarı parçalarını kurumaya bırakın.



- DE Zur besseren Ausbalancierung mit einem Gewicht beschweren.
- GB Add weight for improved stability.
- FR Pour une mise en place correcte allourdir.
- NL Voor evenwicht gewicht aanbrengen.
- IT Aggiungere un peso per migliorare la stabilità.
- ES Añadir peso para una mayor estabilidad.
- PT Para melhor estabilidade colocar um peso.
- DK Tilføj vægt for at forbedre stabiliteten.
- NO Legg til vekt for en bedre stabilitet.
- SE Belastas med en vikt för bättre balansering.
- FI Painota painolla parempaa tasapainottamista varten.
- RU Для лучшей балансировки утяжелить грузом.
- PL Aby zapewnić równowagę, obciążyc ciężarkiem.
- CZ Pro lepší vyvážení zatěžte závažím.
- HU A jobb kiegyensúlyozás érdekében használjon súlynehezéket.
- SK Pre lepšie vyváženie zaťažte závažím.
- NO Aplicati o greutate pentru o mai bună stabilitate.
- GB За по-добър баланс поставете тежест.
- SI Za boljšo izravnavo obtežite z utežjo.
- GR Προσθέστε αντίβαρο για καλύτερη σταθερότητα.
- TR Daha iyi bir dengeleme için ağırlık yerleştirin.



- DE Abziehbild in Wasser einweichen und anbringen.
- GB Soak and apply decals.
- FR Mouiller et appliquer les décalcomanies.
- NL Transfer in water even laten weken en aanbrengen.
- IT Immergere la decalcomania nell'acqua e applicarla.
- ES Mojar y aplicar calcomanías.
- PT Amolecer o decalque em água e aplicar.
- DK Gør overførsbilledet vådt og sæt det på.
- NO Myk opp avtrekingsbildet i vann og sett på.
- SE Blötlägg dekalen i vatten och sätt på den.
- FI Pehmitä siirtokuva vedessä ja siirrä paikalleen.
- RU Опустите переводную картинку в воду и нанесите её.
- PL Namoczyc kalkomanie w wodzie i przykleic.
- CZ Nechte obtisk odmočit ve vodě a přilepte.
- HU Merítse vízbe és helyezze fel a matricát.
- SK Odtlačkový obrázok namočte do vody a priložte na plochu.
- NO Inmuiađi abtjibildul in apă și aplicați-l.
- GB Потопете ваденката във вода и я поставете.
- SI Prelepnico namakajte v vodi. In napestite
- GR Μουσκεψτε σε νερό και τοποθετήστε τις χαλκομανίες.
- TR Çikartmayı suda yumuşatın ve takın.



- DE Zur Anbringung der Abziehbilder empfohlen.
- GB Recommended for affixing the decals.
- FR Recommandé pour l'application des décalcomanies.
- NL Aanbevolen voor het aanbrengen van de transfers.
- IT Raccomandato per l'applicazione delle decalcomanie.
- ES Recomendado para fijar bien las calcomanías.
- PT Recomendado para a fixação dos autocolantes.
- DK Anbefales til anbringelse af overførsbillederne.
- NO Anbefales til å feste avtrekksbilder.
- SE Rekommenderad för montering av klisterdekalerna.
- FI Suositellaan siirtokuvien siirtämiseen.
- RU Рекомендуется для нанесения переводных картинок.
- PL Zalecane do przyklejenia kalkomanii.
- CZ Doporučujeme k umístění obtiskovacích obrázků.
- HU A matrica felhelyezéséhez ajánlható.
- SE Odporuča sa pre umiestnenie odtlačkového obrázku.
- NO Recomandat pentru aplicarea abtjibidurilor.
- GB Препоръчва се за поставяне на ваденки.
- SI Pri nameščanju nalepnice priporočamo.
- GR Συνιστάται για την τοποθέτηση των χαλκομανιών.
- TR Çikartmaların takılması için önerilir.



- DE Nicht enthalten
- GB Not included
- FR Non fourni
- NL Behoort niet tot de levering
- IT Non incluso
- ES No incluido
- PT Não incluído
- DK Medfølger ikke
- NO Ikke inkludert
- SE Ingår ej
- FI Ei sisällä
- HU Nem tartalmaz
- PL Nie wchodzi w zakres dostawy
- CZ Není obsaženo
- HU Nem tartalmazza
- SE Neobsahuje
- NO Nu este inclus
- GB Не се вклучва в комплекта
- SI Ni priloženo
- GR Δεν περιλαμβάνεται
- TR İçermiyor



## Benötigte Farben / Required colours

- FR Peintures nécessaires
- NL Benodigde kleuren
- IT Colori necessari
- ES Colores necesarios
- PT Cores necessárias
- DK Nødvendige farver
- NO Nødvendige farger
- SE Erforderliga färger
- FI Tarvittavat värit
- RU Необходимые краски
- PL Potrzebne kolory
- CZ Potřebné barvy
- HU Szükséges színek
- SK Požadované farby
- RO Culori necesare
- BG Необходими цветове
- SI Potrebne barve
- GR Απαιτούμενα χρώματα
- TR Gerekl renkler

371

A

- DE Hellgrau seidenmatt
- GB Light grey silk matt
- FR Gris clair satiné mat
- NL Lichtgrijs zijdemat
- IT Grigio chiaro opaco satinato
- ES Gris claro mate satinado
- PT Cinza claro mate sedoso
- DK Lysegrå silkematt
- NO Lysgrå silkematt
- SE Ljusgrå sidenmatt
- FI Vaaleanharmaa silkkimatta
- RU Светло-серый шелковисто-матовый
- PL Jasnoszary jedwabście matowy
- CZ Světlá šedá jemně matný
- HU Világosszürke, fakóselymes
- SK Svetlo sivá hodvábne matný
- RO Gri-deschis satinat
- BG Светлосиво коприненоматово
- SI Svetlo-siva svileno-mat
- GR Γκρι ανοιχτό σατινέ
- TR Açık gri ipeksi mat

55

B

- DE Lichtgrün matt
- GB Light green matt
- FR Vert clair mat
- NL Lichtgroen mat
- IT Verde chiaro opaco
- ES Verde claro mate
- PT Verde claro mate
- DK Lysegrøn mat
- NO Lys grønn matt
- SE Ljusgrön matt
- FI Vaaleanvihreä matta
- RU Светло-зелёный матовый
- PL Rozświetlony zielony matowy
- CZ Světlá zelená matný
- HU Halványzöld, fénytelen
- SK Svetlo zelená matný
- RO Verde-deschis mat
- BG Лъчистозелено матово
- SI Svetlo-zelena mat
- GR Πράσινο ανοιχτό ματ
- TR Açık yeşil mat

07

C

- DE Schwarz glänzend
- GB Black gloss
- FR Noir brillant
- NL Zwart glanzend
- IT Nero lucido
- ES Negro brillante
- PT Preto brilhante
- DK Sort blank
- NO Sort glansende
- SE Svart blank
- FI Musta kiiltävä
- RU Чёрный глянцевый
- PL Czarny błyszczący
- CZ Černá lesklý
- HU Fekete, fényes
- SK Čierna lesklý
- RO Negru-strălucitor
- BG Черно гланцово
- SI Črna sijoca
- GR Μαύρο γυαλιστερό
- TR Siyah parlak

05

D

- DE Weiß matt
- GB White matt
- FR Blanc mat
- NL Wit mat
- IT Bianco opaco
- ES Blanco mate
- PT Branco mate
- DK Hvid mat
- NO Hvit matt
- SE Vit matt
- FI Valkoinen matta
- RU Белый матовый
- PL Biały matowy
- CZ Bílá matný
- HU Fehér, fénytelen
- SK Biela matný
- RO Alb mat
- BG Бяло матово
- SI Bela mat
- GR Ασπρο ματ
- TR Beyaz mat

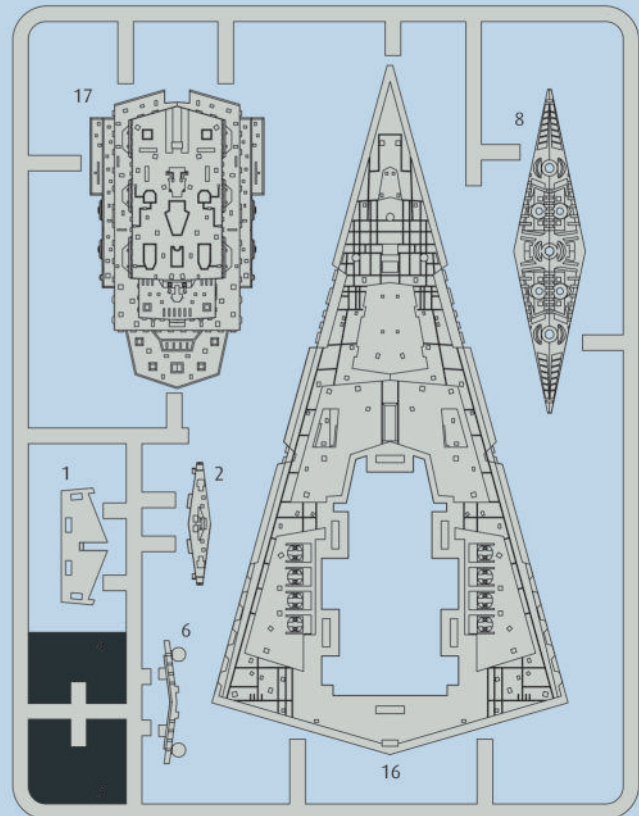
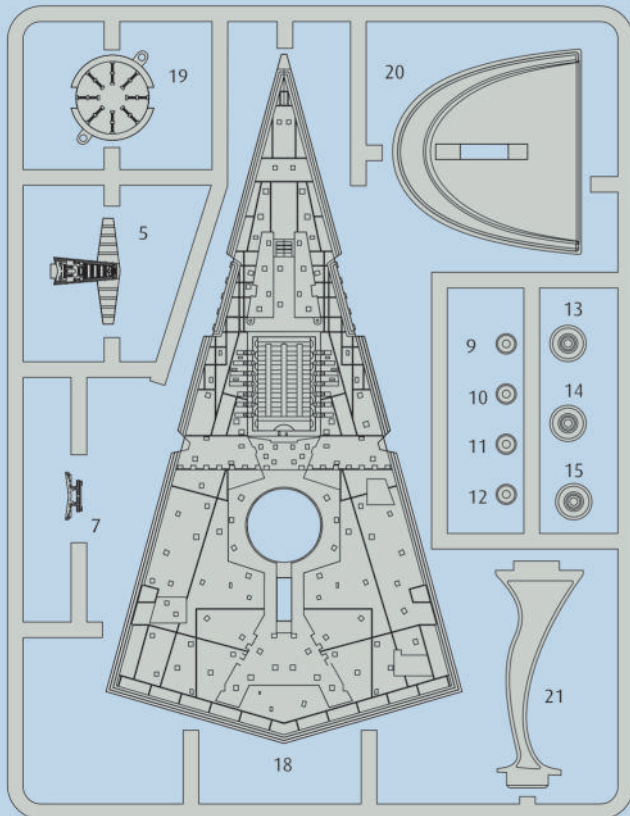

DE Nicht benötigte Teile

FR Parts not used.

FR Pièces non utilisées.

NL Niet benodigde onderdelen.

IT Parti non necessarie.

ES Piezas no utilizadas.

PT Peças não utilizadas.

DE Dele der ikke skal bruges.

NO Deler som ikke er nødvendige.

SE Ej nödvändiga delar.

FI Tarpeettomat osat.

RU Неиспользуемые детали.

PL Niepotrzebne części.

CZ Nepotřebné díly.

HU Szükségtelen alkatrészek.

SK Nepotrebné diely.

RO Piese care nu sunt necesare.

BG Ненужни детайли.

SI Nepotrebni deli.

GR Μη χρησιμοποιούμενα μέρη.

TR Gerekl olmayan parçalar.

## Ersatzteile benötigt?

Kein Problem. Einfach den Revell-Service mit Angabe von Artikel- und Teilenummer kontaktieren. Entweder unter [service@revell.de](mailto:service@revell.de) oder Revell GmbH, Abteilung X, Henschelstr. 20-30, 32257 Bünde.\*

\*Wir bitten um Verständnis, dass eine Gewährleistung nur bei aktuellen Artikeln, die im Zeitraum der letzten 24 Monate erworben wurden, übernommen werden kann. Mit der Ersatzteil-Bestellung können Kosten z.B. für Verpackung und Versand entstehen. Ob diese Kosten anfallen wird im Vorfeld schriftlich durch unseren Service mitgeteilt. Das Angebot kann dann angenommen oder abgelehnt werden. Unfrei eingesandte Ersatzteil-Bestellungen werden von uns nicht angenommen! Dieser Direktservice gilt für die Länder Deutschland, Benelux, Österreich, Frankreich, Großbritannien. Ersatzteil-Bestellungen aus den übrigen Ländern werden über die jeweiligen Distributeure abgewickelt. Bitte kontaktieren Sie Ihren Händler.

## Besoin de pièces de rechange ?

Il vous suffit de contacter le service Revell et d'indiquer la référence de l'article et de la pièce. Soit en écrivant par mail à [service@revell.de](mailto:service@revell.de) (uniquement pour la France) ou par courrier à Revell GmbH, Département X, Henschelstr. 20-30, D-32257 Bünde.\*

\*La garantie s'applique pour les articles présents au catalogue et achetés au cours des 24 derniers mois. Merci de votre compréhension. La commande de pièces de rechange peut donner lieu à des frais supplémentaires, par ex. pour l'emballage et le port. Notre service client vous en informera au préalable par écrit. Vous pourrez accepter ou refuser le devis. Nous n'acceptons pas les commandes de pièces de rechange envoyées sans affranchissement ! Ce service direct est valable pour les pays suivants : Allemagne, Benelux, Autriche, France, Grande-Bretagne. Les commandes de pièces en provenance d'autres pays sont traitées par les distributeurs correspondants. Veuillez contacter votre revendeur.

## Need spare parts?

No problem. Contact Revell Service with the item number and part numbers you need: [service@revell.de](mailto:service@revell.de) or Revell GmbH, Unit 10, Old Airfield Industrial Estate, Cheddington Lane, Tring, Herts, HP23 4QR, Great Britain.\*

\*We request your understanding that a warranty can only be accepted for current articles which have been purchased in the last 24 months. Orders for spare parts may also be subject to costs for packaging and shipping. You will be notified in advance by our Service department if such costs are incurred. The offer can then be accepted or rejected. We will not be able to process any postal requests unless correct postage has been applied to mailing! This direct service applies to the countries: Germany, Benelux, Austria, France, and the United Kingdom. Spare part orders from other countries are processed by the local distributors. Please contact your dealer.

## Hebt u reserveonderdelen nodig?

Geen probleem! Neem eenvoudig contact op met de klantenservice van Revell en geef ons het artikel- en onderdeelnummer door. U kunt ons bereiken op [service@revell.de](mailto:service@revell.de) of per post: Revell GmbH, Afdeling X, Henschelstr. 20-30, 32257 Bünde.\*

\*Wij vragen uw begrip voor de omstandigheid, dat er alleen garantie kan worden geboden voor actuele artikelen, die in de afgelopen 24 maanden zijn gekocht. Met het bestellen van reserveonderdelen kunnen kosten gemoeid zijn, bijv. voor verpakking en verzending. U wordt vooraf schriftelijk door onze klantenservice op de hoogte gesteld als er kosten zouden ontstaan. Het aanbod kan dan worden aangenomen of afgewezen. Wij nemen geen ongefrankeerde bestellingen van reserveonderdelen aan! Deze rechtstreekse service wordt verleend in de landen Duitsland, de Benelux, Oostenrijk, Frankrijk en Groot-Brittannië. Bestellingen van reserveonderdelen in de overige landen worden afgewikkeld via de betreffende distributeurs. Neem hiervoor contact op met uw verkoper.

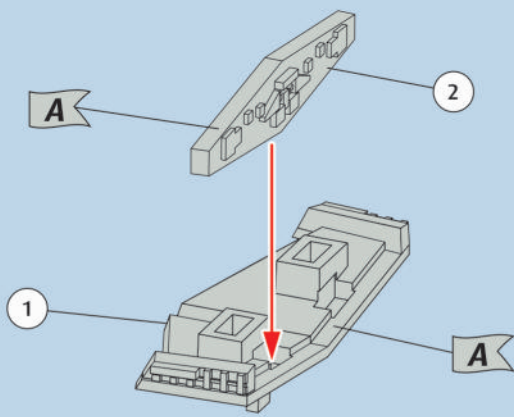
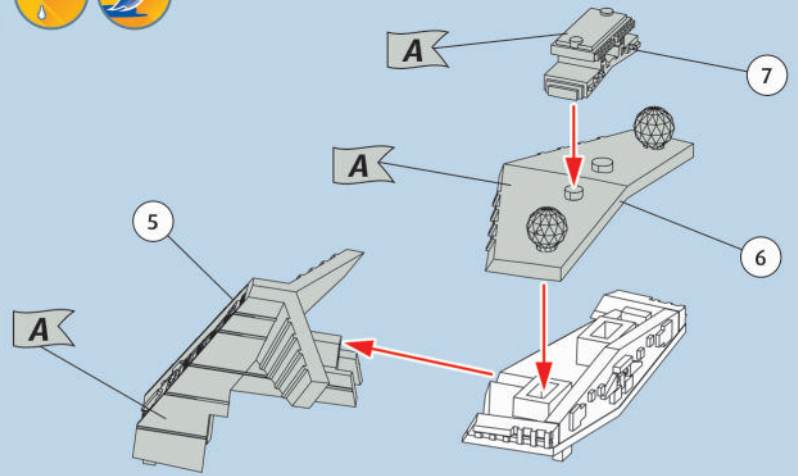
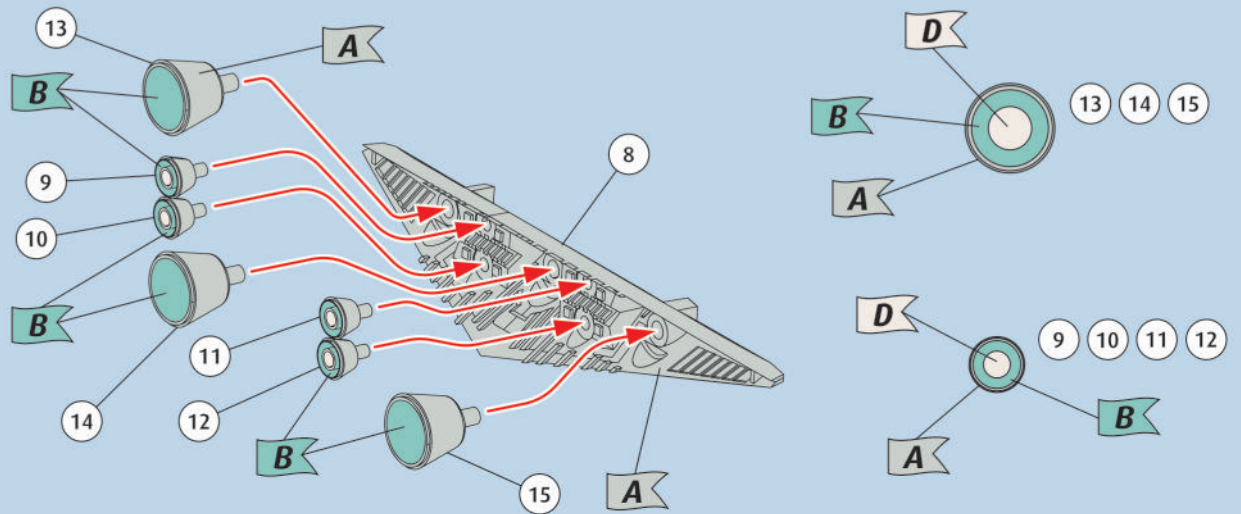
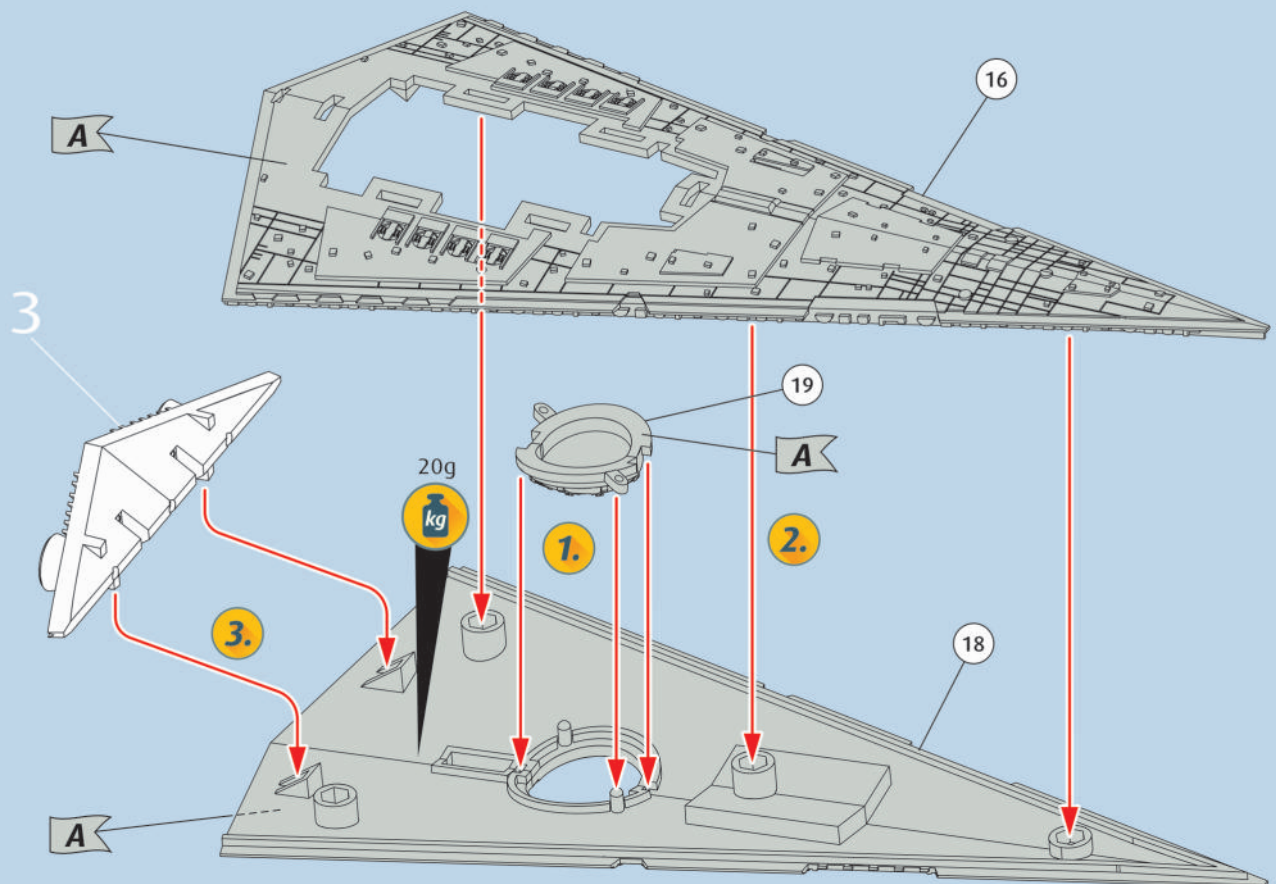

1  2  3  4  

5  

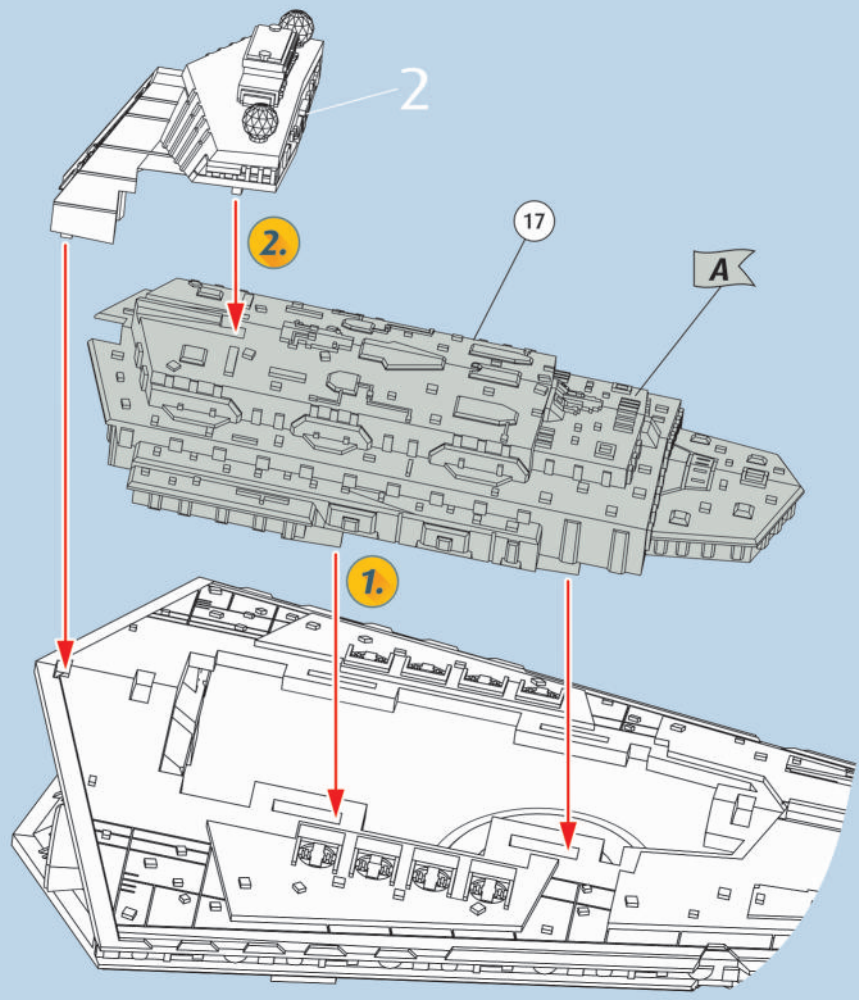

6    

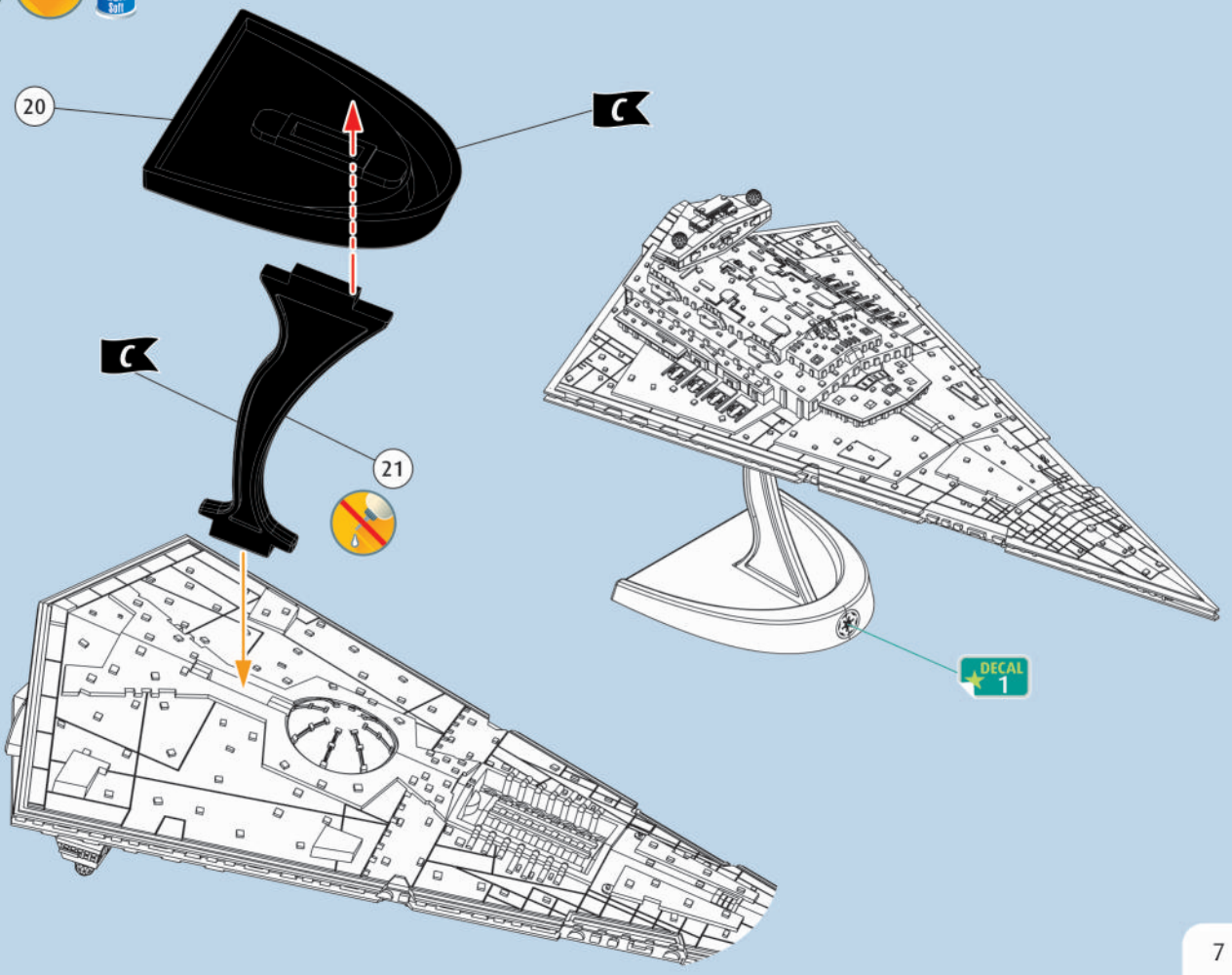





- A
- B
- C
- D

