



01030-0379

# easy-click system



## DEUTZ D30

Beiliegenden Sicherheitstext beachten / Please note the enclosed safety advice

- Ⓢ Beiliegenden Sicherheitstext beachten und nachschlagbereit halten.
- Ⓢ Please note the enclosed safety advice and keep safe for later reference.
- Ⓢ Respecter les consignes de sécurité ci-jointes et les conserver à portée de main.
- Ⓢ Houdt u aan de bijgaande veiligheidsinstructies en hou deze steeds bij de hand.
- Ⓢ Seguire le avvertenze di sicurezza allegate e tenerle a portata di mano.
- Ⓢ Observar y siempre tener a disposición este texto de seguridad adjunto.
- Ⓢ Ter em atenção o texto de segurança anexo e guardá-lo para consulta.
- Ⓢ Overhold vedlagte sikkerhedsanvisninger og hav dem liggende i nærheden.
- Ⓢ Ha alltid vedlagt sikkerhetstekst klar til bruk.
- Ⓢ Beakta bifogad säkerhetstext och håll den i beredskap.
- Ⓢ Huomioi ja säilytä oheiset varoitukset.
- Ⓢ Соблюдать технику безопасности, сохранить инструкцию для дальнейших обращений.
- Ⓢ Przestrzegać załączonego tekstu dotyczącego bezpieczeństwa i mieć go zawsze pod ręką.
- Ⓢ Dodržujte tento příložený bezpečnostní text a mějte ho po ruce.
- Ⓢ A mellékelt biztonsági szöveget vegye figyelembe és tartsa fellapozásra készen.
- Ⓢ Respektujte příložený bezpečnostní text a uchovajte ho pre budúce použitie.
- Ⓢ Respectați textul de siguranță atașat și păstrați-l la îndemână.
- Ⓢ Спазвайте приложения текст за безопасност и го дръжте под ръка за справки.
- Ⓢ Priložena varnostna navodila izvajajte in jih hranite na vsem dostopnem mestu.
- Ⓢ Λάβετε υπόψη σας το συννημένο κείμενο ασφαλείας και φυλάξτε το ώστε να ανατρέχετε σε αυτό όποτε χρειάζεται.
- Ⓢ Ektekiqüvenlik talimatlarını dikkate alıp, bakabileceğiniz bir şekilde muafaza ediniz.

© 2020 Revell GmbH, Henschelstr. 20-30, D-32257 Bünde.

REVELL IS THE REGISTERED TRADEMARK OF REVELL GMBH, GERMANY. [www.revell.de](http://www.revell.de)

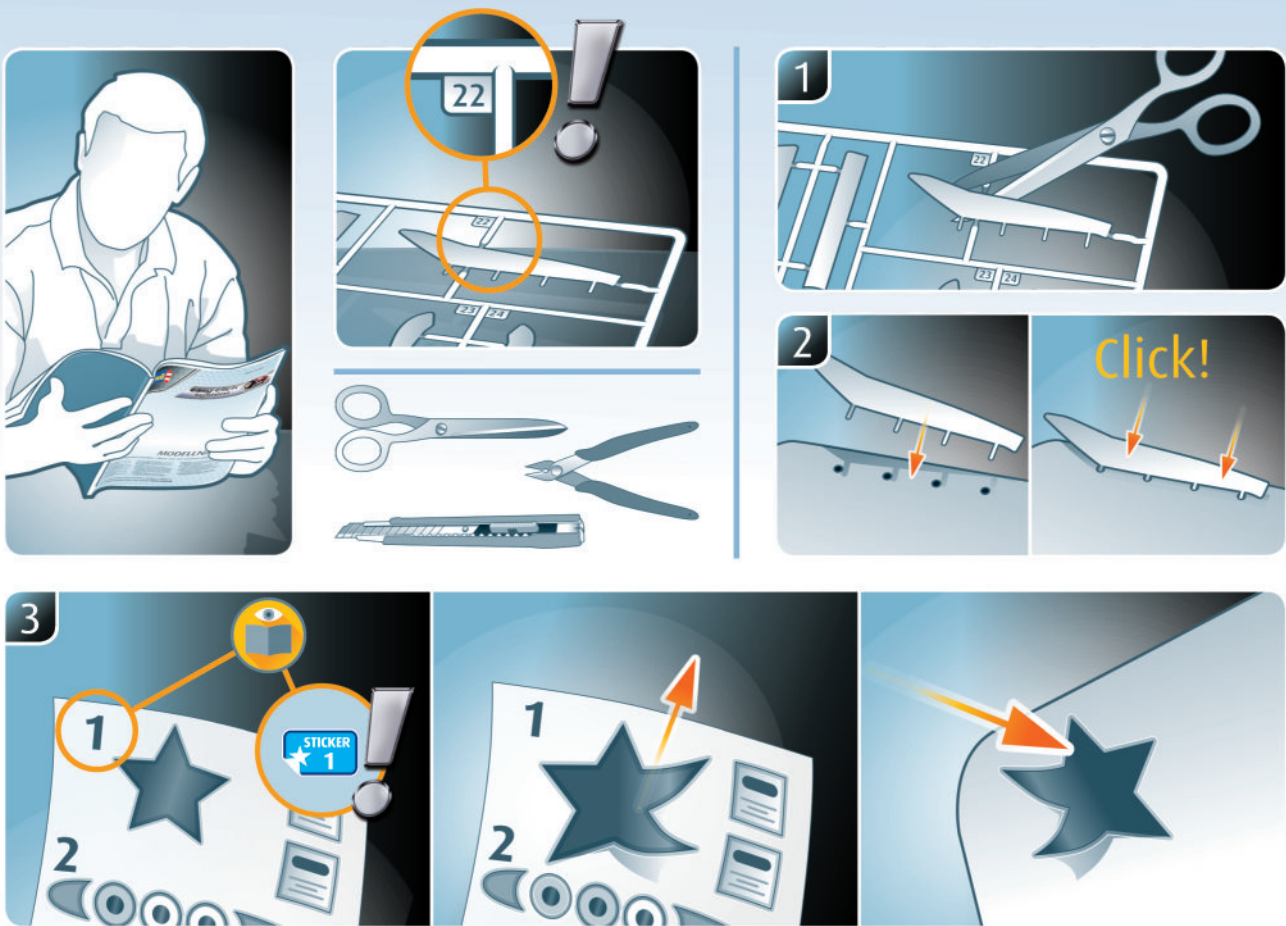

## Painting

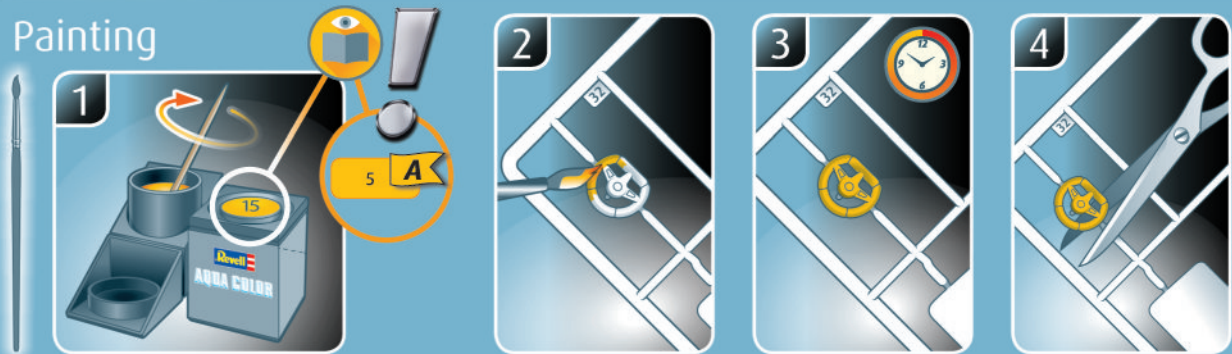

## Decals

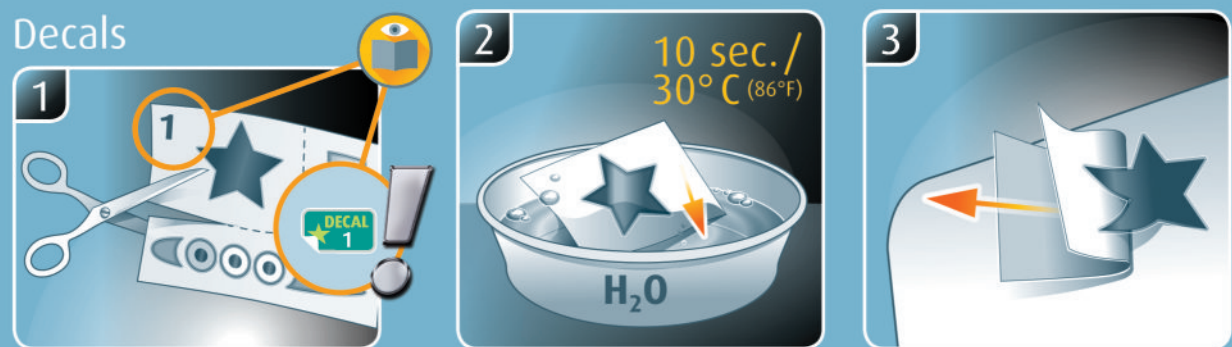

OPTIONAL • OPTIONAL • EN OPTION  
OPTIONEEL • OPCIONAL • OPTIONAL \*



(T) Weitere Tipps und Tricks.  
 (C) Additional tips and tricks.  
 (R) Conseils et astuces supplémentaires.  
 (E) Andere tips en trucs.  
 (T) Ulteriori consigli e suggerimenti.  
 (S) Consejos y sugerencias adicionales.  
 (P) Mais dicas e truques.  
 (X) Flere tips og tricks.  
 (N) Flere tips og tricks.  
 (E) Ytterligare tips och tricks.  
 (L) Lisää vinkkejä ja niksejä.  
 (R) Другие советы и хитрости.

(P) Dalsze wskazówki i sugestie.  
 (C) Další tipy a rady.  
 (R) További ötletek és fogások.  
 (E) Dalsie tipy a triky.  
 (R) Alte sfaturi și trucuri.  
 (S) Други полезни съвети и трикове.  
 (S) Nadaljni nasveti in zvižče.  
 (E) Πρόσθετες συμβουλές και κόλπα.  
 (T) Diğər önerilər və ipuçları.

www.revell.de

\* (P) Opcional  
 (C) Valgfritt  
 (R) Valgfritt  
 (E) Övrigt  
 (R) Valinnainen  
 (S) Дополнительно  
 (L) Opcja  
 (Z) Voliteľný krok

(H) Opcióként  
 (S) Voliteľné  
 (R) Opțional  
 (E) Опция  
 (S) Dodatno  
 (E) Προαιρετικά  
 (T) Opsiyonel



- DE Bemalen
- FR Paint
- FR Peindre
- NL Beschilderen
- IT Colorare
- ES Pintar
- PT Pintar
- CS Mal
- NO Male
- SE Måla
- FI Maalaa
- RU Раскрасить
- PL Pomalować
- CZ Pomalovat
- HU Fesse be
- SK Natrief
- NO Vopstijt
- BG Боядисайте
- SI Pobavajte
- GR Βάψτε
- TR Boyama



- DE Zusammenbau Reihenfolge.
- FR Sequence of assembly.
- FR Ordre d'assemblage.
- NL Volgorde van montage.
- IT Sequenza di assemblaggio.
- ES Secuencia de montaje.
- PT Sequência de montagem.
- CS Samlerækkefølge.
- NO Monteringsrekkefølge.
- SE Montering ordningsföljd.
- FI Kokoamisjärjestys.
- RU Последовательность сборки.
- PL Kolejność montażu.
- CZ Pořadí složení.
- HU Ősszerakási sorrend.
- SK Poradie zostavenia.
- NO Ordinea asamblării.
- BG Последовательност на сглобяване.
- SI Vrstni red sestavljanja.
- GR Σειρά τοποθέτησης.
- TR Parçaları birleştirme sırası.



- DE Anzahl der Arbeitsgänge.
- FR Number of working steps.
- FR Nombre d'étapes de travail.
- NL Het aantal bouwstappen.
- IT Numero di fasi di lavoro.
- ES Número de pasos de trabajo.
- PT Número de passos de trabalho.
- CS Antall arbejds-gange.
- NO Antall arbeidstrinn.
- SE Antal operationer.
- FI Työvaiheiden määrä.
- RU Количество операций.
- PL Liczba cykli roboczych.
- CZ Počet pracovních kroků.
- HU A munkamenetek száma.
- SK Počet pracovných operácií.
- NO Numărul etapelor de lucru.
- BG Брой работни стъпки.
- SI Številno delovnih postopkov.
- GR Αριθμός βημάτων εργασίας.
- TR Çalışma adımı sayısı.



- DE Achtung
- FR Attention
- FR Attention
- NL Obgelet
- IT Attenzione
- ES Atención
- PT Atenção
- CS Obs!
- NO OBS
- SE OBS
- FI Huomio
- RU Внимание
- PL Uwaga
- CZ Pozor
- HU Figyelem!
- SK Pozor
- NO Atentje
- BG Внимание
- SI Pozor
- GR Προσοχή
- TR Dikkat



- DE Wahlweise
- FR Optional
- FR Facultatif
- NL Naar keuze
- IT Facoltativamente
- ES Opcional
- PT Opcional
- CS Valgfri
- NO Valgfritt
- SE Valfri
- FI Valinnaisesti
- RU На выбор
- PL Opcjonalnie
- CZ Volitelné
- HU Választás szerint
- SK Alternativne
- NO Optional
- BG По избор
- SI Izbirno
- GR Προαιρετικά
- TR Opsiyonel



- DE Entfernen
- FR Remove
- FR Détacher
- NL Verwijderen
- IT Rimuovere
- ES Eliminar
- PT Remover
- CS Fjern
- NO Fjerne
- SE Ta bort
- FI Poistaa
- RU Удалить
- PL Usunąć
- CZ Odstranit
- HU Eltávolítani
- SK Odstráňte
- NO İndepårtati
- BG Отстранете
- SI Odstranitev
- GR Αφαιρέστε
- TR Çıkar



- DE Bauleitung sorgfältig lesen.
- FR Read the assembly instructions carefully.
- FR Lisez attentivement les instructions de montage.
- NL Bouwinstructies zorgvuldig doorlezen.
- IT Leggere attentamente le istruzioni per il montaggio.
- ES Lea cuidadosamente las instrucciones de montaje.
- PT Ler atentamente as instruções de montagem.
- CS Les byggevejledningen omhyggeligt.
- NO Les byggeanvisningene nøye.
- SE Monteringsinstruktionerna skall läsas noggrant.
- FI Lue kokoamisohje huolellisesti.
- RU Внимательно прочитайте инструкцию по сборке.
- PL Dokładnie przeczytać instrukcję montażu.
- CZ Přečtěte si pečlivě návod k obsluze.
- HU Figyelmesen olvassa el a szerelési útmutatót.
- SK Návod na montáž starostlivo prečítajte.
- NO Citiji cu atenție instrucțiunile de montare.
- BG Прочетете внимателно упътването за монтаж.
- SI Skrbno preberite navodila za sestavo.
- GR Διαβάστε προσεκτικά τις οδηγίες κατασκευής.
- TR Yapı kılavuzunu dikkatle okuyun.



- DE Gleichen Vorgang auf der gegenüberliegenden Seite wiederholen.
- FR Repeat same procedure on opposite side.
- FR Opérer de la même façon sur l'autre face.
- NL Dezelfde handeling herhalen aan de tegenoverliggende kant.
- IT Ripetere il procedimento dall'altra parte.
- ES Repetir el mismo procedimiento en el lado contrario.
- PT Repetir alguns procedimentos no lado oposto.
- CS Gentag proceduren på den modstående side.
- NO Gjenta samme forløp på motliggende side.
- SE Upprepa samma process på motsatta sidan.
- FI Toista menettelyä vastakkaisella puolella.
- RU Повторить такие же действия на противоположной стороне.
- PL Powtórzyć te same czynności po przeciwnej stronie.
- CZ Stejný postup opakujte na protilehlé straně.
- HU Ismétélje meg a műveletet az ellentétes oldalon.
- SK Rovnaký postup zopakujte na protifahej strane.
- NO Repetati același procedeu pe latura opusă.
- BG Повторете същите стъпки на срещуположната страна.
- SI Enak postopek ponovite na nasprotni strani.
- GR Επαναλάβετε την ίδια διαδικασία στην αντίθετη πλευρά.
- TR Aynı işlem adımlarını diğer tarafta da uygulayın.



- DE Klarsichtteile
- FR Clear parts
- FR Pièces transparentes
- NL Transparente onderdelen
- IT Parti trasparenti
- ES Piezas transparentes
- PT Peças transparentes
- CS Klare dele
- NO Klare deler
- SE Genomskinliga detaljer
- FI Läpinäkyvät osat
- RU Прозрачные детали
- PL Przezroczyste części
- CZ Průhledné díly
- HU Átlátszó alkatrészek
- SK Číre diely
- NO Piese transparente
- BG Прозрачни части
- SI Prozorni deli
- GR Διαφανήέρη
- TR Şeffaf parçalar



- DE Chromteile
- FR Chrome parts
- FR Pièces chromées
- NL Chrom onderdelen
- IT Parti cromate
- ES Piezas cromadas
- PT Peças de cromo
- NO Forkromede dele
- SE Kromdeler
- FI Kromdetaljer
- RU Хромовые детали
- PL Części chromowane
- CZ Chromované díly
- HU Króm alkatrészek
- SK Chromované diely
- NO Piese cromate
- BG Хромови части
- SI Kromirani deli
- GR Μέρη χρωμίου
- TR Krom parçalar



- DE Abbildung zusammengesetzter Teile.
- FR Illustration of assembled parts.
- FR Figure représentant les pièces assemblées.
- NL Afbeelding van samengevoegde onderdelen.
- IT Foto delle parti assemblate.
- ES Figura de las piezas montadas.
- PT Ilustração das peças montadas.
- CS Ilustration af samlede dele.
- NO Figur av sammensatte deler.
- SE Bild på sammansatta detaljer.
- FI Kootujen osien kuva.
- RU Изображение смонтированных деталей.
- PL Rysunek połączonych części.
- CZ Zobrazení spojených dílů.
- HU Ősszerakott alkatrészek ábrája.
- SK Obrázok dielov, ktoré sa majú zmontovať.
- NO Figura reprezentând piesele asamblate.
- BG Изображение на сглобените части.
- SI Slika sestavljenih delov.
- GR Απεικόνιση των τοποθετημένων μερών.
- TR Birleştirilmiş parçalar resmi.



- DE Nicht enthalten
- FR Not included
- FR Non fourni
- NL Behoort niet tot de levering
- IT Non incluso
- ES No incluido
- PT Não incluído
- CS Medfalger ikke
- NO Ikke inkludert
- SE Ingår ej
- FI Ei sisällä
- RU Не содержится
- PL Nie wchodzi w zakres dostawy
- CZ Není obsaženo
- HU Nem tartalmazza
- SK Neobsahuje
- NO Nu este inclus
- BG Не се включва в комплекта
- SI Ni priloženo
- GR Δεν περιλαμβάνεται
- TR İçermiyor

**OPTIONAL · OPTIONAL · EN OPTION · OPTIONEEL · OPCIONAL · OPTIONAL \***

☞ Optional kann das Modell zusätzlich bemalt werden und wird damit zum ganz persönlichen Unikat. Wir empfehlen folgende Revell-Farben:

☞ The model can also be painted, which makes it completely unique. We recommend the following Revell paints:

☞ En option, il est aussi possible de peindre le modèle. Il devient alors une pièce vraiment unique et personnalisée. Nous vous recommandons les couleurs Revell suivantes :

☞ Optoneel kan het model aanvullend worden beschilderd om het een heel persoonlijke, unieke uitstraling te geven. Wij bevelen de volgende verf van Revell aan:

☞ Opcionalmente, el modelo se puede pintar para convertirlo en una pieza única personalizada. Recomendamos las siguientes pinturas de Revell:

☞ In via opzionale il modellino può essere verniciato per ottenere un esemplare del tutto personalizzato. Consigliamo di utilizzare i seguenti colori Revell:

☞ Opcionalmente, o modelo pode ser ainda pintado, dando-lhe um caráter pessoal único. Recomendamos as seguintes tintas Revell:

☞ Du kan vælge også at male modellen, som på den måde bliver personlig og unik. Vi anbefaler følgende Revell-farver:

☞ Du har mulighed til å gjøre modellen helt unik ved å male den. Vi anbefaler følgende Revell-farger:

☞ Modellen kan även målas och därmed bli en helt unik Unikat. Vi rekommenderar följande Revell-färger:

☞ Jos haluat yksilöllisen lopputuloksen, voit halutessasi myös maalata mallin. Suosittelemme käyttämään seuraavia Revell-maaleja:

☞ В качестве дополнения модель может быть окрашена, что придаст ей персональные, уникальные черты. Мы рекомендуем следующие цвета Revell:

☞ Opcjonalnie można dodatkowo pomalować model, który dzięki temu będzie całkowicie osobistym unikatem. Polecamy następujące farby Revell:

☞ Model se může dodatečně pomalovat, čímž vznikne zcela jedinečný originál. Doporučujeme použít barvy značky Revell:

☞ Opcióként a modell kiegészítő festéssel is ellátható, így igazán egyedivé tehető. Ehhez a következő Revell festékeket ajánljuk:

☞ Model sa môže dodatočne pomalovať, čím vznikne celkom jedinečný originál. Odporúčame použiť tieto farby značky Revell:

☞ Opțional, pentru un aspect unic, personalizat, pe model se poate aplica un strat suplimentar de vopsea. Vă recomandăm următoarele vopsele Revell:

☞ Опционално моделът може допълнително да бъде изпълнен в друг цвят и да се превърне в абсолютен уникат. Препоръчваме следните цветове на Revell:

☞ Po želji je moguće model dodatno prebarviti in ga tako spremeniti v osebni unikat. Priporočamo naslednje barve Revell:

☞ Προαιρετικά μπορεί το μοντέλο να βαφεί και να γίνει ένα τελείως προσωπικό μοναδικό κομμάτι. Συνιστούμε τα παρακάτω χρώματα Revell:

☞ Opsiyonel olarak model boyanabilir ve benzersiz hale getirilebilir. Şu Revell renklerini tavsiye ediyoruz:

330

A

- ☞ Feuerrot seidenmatt
- ☞ Fiery red silk matt
- ☞ Rouge feu satiné mat
- ☞ Vuurood zijdemat
- ☞ Rosso fuoco opaco satinato
- ☞ Rojo fuego mate satinado
- ☞ Vermelho fogo mate sedoso
- ☞ Ildröd silkematt
- ☞ Ildröd silkematt
- ☞ Eldröd sidenmatt
- ☞ Tulenpunainen silkkimatta
- ☞ Огненно-красный шелковисто-матовый
- ☞ Ognistoczerwony jedwabiscie matowy
- ☞ Ohnivě červená jemně matný
- ☞ Tűzpiros, fakóselymes
- ☞ Ohnivá červená hodvábné matný
- ☞ Roşu aprins satinat
- ☞ Огнечервено коприненоматово
- ☞ Ognjeno-rdeča svileni-mat
- ☞ Κόκκινο φωτιάς σατινέ
- ☞ Alev kırmızısi ipeksi mat

302

B

- ☞ Schwarz seidenmatt
- ☞ Black silk matt
- ☞ Noir satiné mat
- ☞ Zwart zijdemat
- ☞ Nero opaco satinato
- ☞ Negro mate satinado
- ☞ Preto mate sedoso
- ☞ Sort silkematt
- ☞ Sort silkematt
- ☞ Svart sidenmatt
- ☞ Musta silkkimatta
- ☞ Чёрный шелковисто-матовый
- ☞ Czarna jedwabiscie matowy
- ☞ Černá jemně matný
- ☞ Fekete, fakóselymes
- ☞ Čierna hodvábné matný
- ☞ Negru satinat
- ☞ Черно коприненоматово
- ☞ Črna svileni-mat
- ☞ Μαύρο σατινέ
- ☞ Siyah ipeksi mat

90

C

- ☞ Silber metalllic
- ☞ Silver metallic
- ☞ Argent métallique
- ☞ Zilver metallic
- ☞ Argento metallico
- ☞ Plata metálico
- ☞ Prata metálico
- ☞ Sølv metallisk
- ☞ Sølv metallic
- ☞ Silver metallic
- ☞ Hopea metallinen
- ☞ Серебрянный металллик
- ☞ Srebrny metaliczny
- ☞ Stříbrná metalizovaný
- ☞ Ezüstmetál
- ☞ Strieborná metaliza
- ☞ Argintiu metalic
- ☞ Сребро металлик
- ☞ Srebrna kovinska
- ☞ Ασημί μεταλλικό
- ☞ Gümüş rengi metalik

07

D

- ☞ Schwarz glänzend
- ☞ Black gloss
- ☞ Noir brillant
- ☞ Zwart glanzend
- ☞ Nero lucido
- ☞ Negro brillante
- ☞ Preto brilhante
- ☞ Sort blank
- ☞ Sort glansende
- ☞ Svart blank
- ☞ Musta kiiltävä
- ☞ Чёрный глянецовый
- ☞ Czarny błyszczący
- ☞ Černá lesklý
- ☞ Fekete, fényes
- ☞ Čierna lesklý
- ☞ Negru-strălucitor
- ☞ Черно глянцево
- ☞ Črna sijoca
- ☞ Μαύρο γυαλιστερό
- ☞ Siyah parlak

382

E

- ☞ Holzbraun seidenmatt
- ☞ Wood brown silk matt
- ☞ Brun bois satiné mat
- ☞ Houtbruin zijdemat
- ☞ Marrone legno opaco satinato
- ☞ Marrón madera mate satinado
- ☞ Castanho madeira mate sedoso
- ☞ Træbrun silkematt
- ☞ Trebrun silkematt
- ☞ Træbrun sidenmatt
- ☞ Puunruskea silkkimatta
- ☞ Древесно-коричневый шелковисто-матовый
- ☞ Brązowy w odcieniu drewna jedwabiscie matowy
- ☞ Dřevěná hnědá jemně matný
- ☞ Fa barna, fakóselymes
- ☞ Drevená hnědá hodvábné matný
- ☞ Maro lemno satinat
- ☞ Дървеснокафяво коприненоматово
- ☞ Lesno-gjava svileni-mat
- ☞ Καφέ ανοιχτό σατινέ
- ☞ Ahsap rengi ipeksi mat

\* ☞ Opcional  
☞ Valgfritt  
☞ Valgfritt

☞ Övrigt  
☞ Valinnainen  
☞ Дополнительно

☞ Opcja  
☞ Voliteľný krok  
☞ Opcióként

☞ Voliteľné  
☞ Opțional  
☞ Опция

☞ Dodatno  
☞ Προαιρετικά  
☞ Opsiyonel

**⚠ WARNING: READ THIS BEFORE YOU BEGIN**

- \* **Carefully study the assembly drawings to the contents in this plastic kit.**
- \* Each plastic part is identified by a number.
- \* In the assembly drawings, some parts will be marked by a star  to indicate chrome plated plastic.
- \* For better paint and decal adhesion, wash the plastic parts in a mild detergent solution. Rinse and let air dry.
- \* Check the fit of each piece before cementing in place.
- \* Use only cement for polystyrene plastic.
- \* Scrape plating and paint from areas to be cemented.
- \* Allow paint to dry thoroughly before handling parts.
- \* Any unused parts may be discarded.

**⚠ AVERTISSEMENT : LIRE CECI AVANT DE COMMENCER**

- \* **Étudiez attentivement les dessins d'assemblage jusqu'au contenu de ce kit en plastique.**
- \* Chaque pièce en plastique est identifiée par un numéro.
- \* Sur les dessins d'assemblage, les pièces marquées d'une étoile  sont en plastique chromé.
- \* Pour une meilleure adhérence de la peinture et des décalcomanies, lavez les pièces en plastique dans une solution de détergent doux. Rincez et laissez sécher à l'air.
- \* Vérifiez l'ajustement de chaque pièce avant de cimenter en place.
- \* Utilisez seulement du ciment pour plastique polystyrène.
- \* Raclez le placage et la peinture des zones à cimenter.
- \* Laissez bien sécher la peinture avant de manipuler les pièces.
- \* Toute pièce inutilisée peut être jetée.

**⚠ ADVERTENCIA: LEER ESTO ANTES DE COMENZAR**

- \* **Estudie cuidadosamente los dibujos de ensamble a los contenidos de este kit de plástico.**
- \* Cada pieza de plástico se identifica con un número.
- \* En los esquemas de montaje, algunas piezas se señalarán con una estrella  para indicar plástico cromado.
- \* Para conseguir una mejor adhesión de las calcomanías, lavar las piezas de plástico con una solución de detergente suave. Enjuagar y dejar secar al aire.
- \* Comprobar el ajuste de cada pieza antes de fijar en su sitio con cemento.
- \* Usar sólo cemento para plástico de poliestireno.
- \* Rascar el cromado y la pintura de las áreas que se vayan a pegar.
- \* Dejar que la pintura se seque completamente antes de manipular las piezas.
- \* Las piezas que no se utilicen pueden desecharse.

**CUSTOMER SERVICE**

If you have questions or problems visit our website [revell.com](http://revell.com) or write to us at:

**Revell GmbH, Consumer Service,  
Henschelstr. 20-30, 32257 Bünde, Germany**

Be sure to include this plan number (01030-0379), part number, description and your return address and phone number.

**SERVICE CLIENTÈLE**

En cas de questions ou problèmes, consultez notre site Web [revell.com](http://revell.com) ou écrivez-nous à :

**Revell GmbH, Consumer Service,  
Henschelstr. 20-30, 32257 Bünde, Germany**

Veillez à inclure ce numéro de plan (01030-0379), le numéro de pièce, la description de la pièce, votre adresse de retour et votre numéro de téléphone.

**ATENCIÓN AL CLIENTE**

Si tiene alguna pregunta o problema, visite nuestro sitio web, [revell.com](http://revell.com), o escríbanos a:

**Revell GmbH, Consumer Service,  
Henschelstr. 20-30, 32257 Bünde, Germany**

Asegúrese de incluir el número de plan (01030-0379), número de pieza, descripción, y su dirección postal y número de teléfono.

**Revell USA, L.L.C., 728 Northwest HWY, #302, Fox River Grove, IL, 60021 USA, +1-847-975-5896**

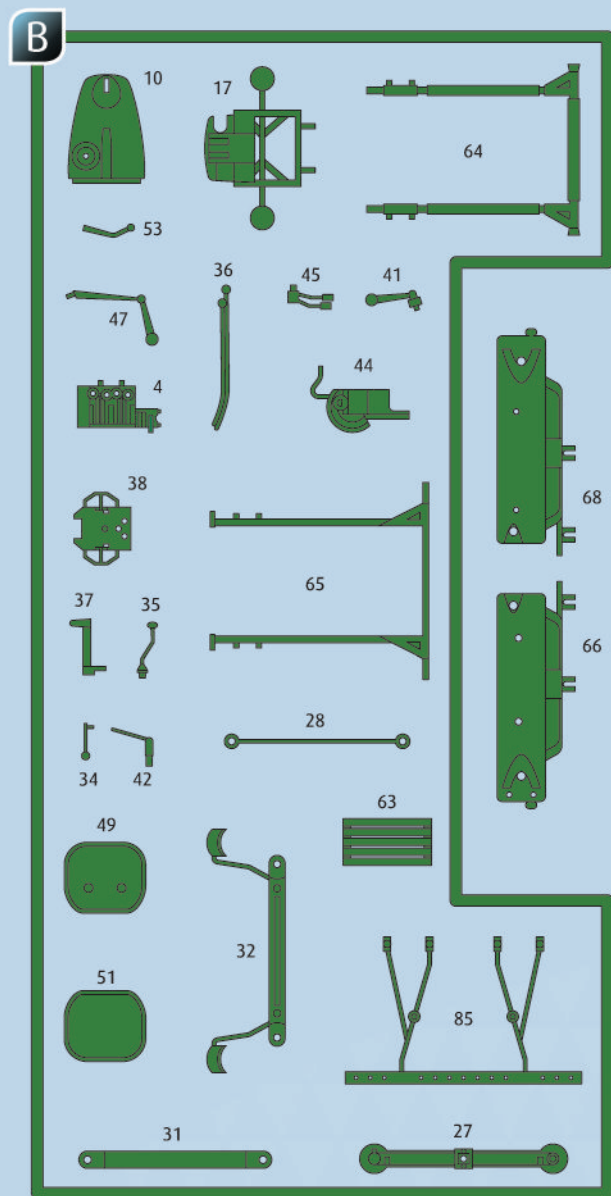
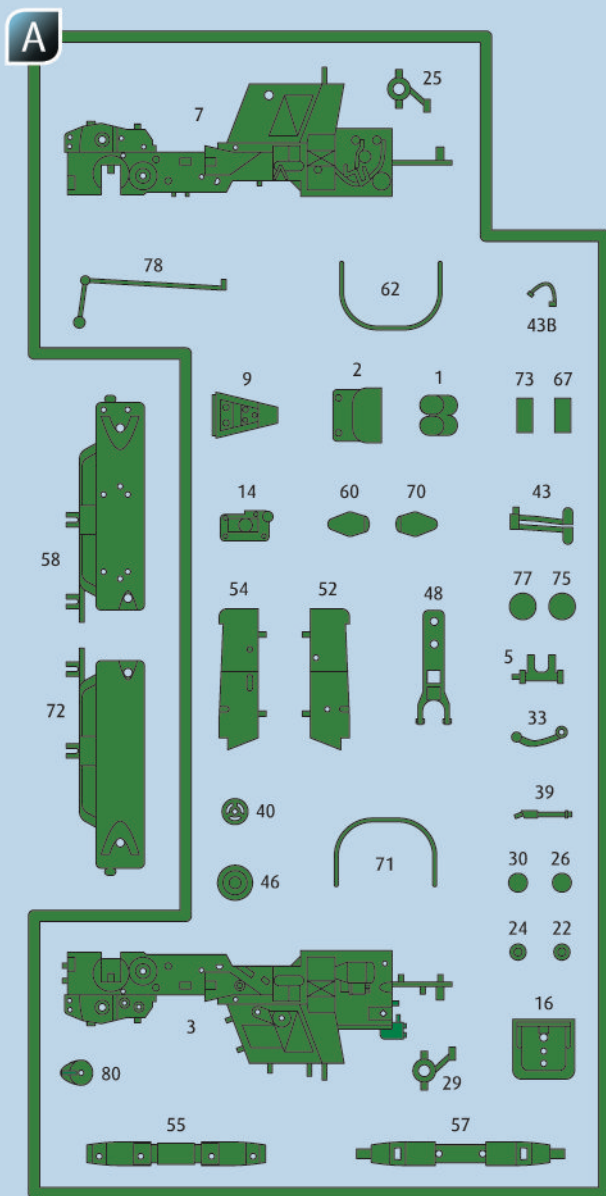

### Ersatzteile benötigt?

Kein Problem. Einfach den Revell-Service mit Angabe von Artikel- und Teilenummer kontaktieren. Entweder unter [service@revell.de](mailto:service@revell.de) oder Revell GmbH, Abteilung X, Henschelstr. 20-30, 32257 Bünde.\*

\*Wir bitten um Verständnis, dass eine Gewährleistung nur bei aktuellen Artikeln, die im Zeitraum der letzten 24 Monate erworben wurden, übernommen werden kann. Mit der Ersatzteil-Bestellung können Kosten z.B. für Verpackung und Versand entstehen. Ob diese Kosten anfallen wird im Vorfeld schriftlich durch unseren Service mitgeteilt. Das Angebot kann dann angenommen oder abgelehnt werden. Unfrei eingesandte Ersatzteil-Bestellungen werden von uns nicht angenommen! Dieser Direktservice gilt für die Länder Deutschland, Benelux, Österreich, Frankreich, Großbritannien. Ersatzteil-Bestellungen aus den übrigen Ländern werden über die jeweiligen Distributeure abgewickelt. Bitte kontaktieren Sie Ihren Händler.

### Besoin de pièces de rechange ?

Il vous suffit de contacter le service Revell et d'indiquer la référence de l'article et de la pièce. Soit en écrivant par mail à [france@revell.de](mailto:france@revell.de) (uniquement pour la France) ou par courrier à Revell GmbH, Département X, Henschelstr. 20-30, D-32257 Bünde.\*

\*La garantie s'applique pour les articles présents au catalogue et achetés au cours des 24 derniers mois. Merci de votre compréhension. La commande de pièces de rechange peut donner lieu à des frais supplémentaires, par ex. pour l'emballage et le port. Notre service client vous en informera au préalable par écrit. Vous pourrez accepter ou refuser le devis. Nous n'acceptons pas les commandes de pièces de rechange envoyées sans affranchissement ! Ce service direct est valable pour les pays suivants : Allemagne, Benelux, Autriche, France, Grande-Bretagne. Les commandes de pièces en provenance d'autres pays sont traitées par les distributeurs correspondants. Veuillez contacter votre revendeur.

### Need spare parts?

No problem. Contact Revell Service with the item number and part numbers you need: [service@revell.de](mailto:service@revell.de) or Revell GmbH, Unit 10, Old Airfield Industrial Estate, Cheddington Lane, Tring, Herts, HP23 4QR, Great Britain.\*

\*We request your understanding that a warranty can only be accepted for current articles which have been purchased in the last 24 months. Orders for spare parts may also be subject to costs for packaging and shipping. You will be notified in advance by our Service department if such costs are incurred. The offer can then be accepted or rejected. We will not be able to process any postal requests unless correct postage has been applied to mailing! This direct service applies to the countries: Germany, Benelux, Austria, France, and the United Kingdom. Spare part orders from other countries are processed by the local distributors. Please contact your dealer.

### Hebt u reserveonderdelen nodig?

Geen probleem! Neem eenvoudig contact op met de klantenservice van Revell en geef ons het artikel- en onderdeelnummer door. U kunt ons bereiken op [service@revell.de](mailto:service@revell.de) of per post: Revell GmbH, Afdeling X, Henschelstr. 20-30, 32257 Bünde.\*

\*Wij vragen uw begrip voor de omstandigheid, dat er alleen garantie kan worden geboden voor actuele artikelen, die in de afgelopen 24 maanden zijn gekocht. Met het bestellen van reserveonderdelen kunnen kosten gemoeid zijn, bijv. voor verpakking en verzending. U wordt vooraf schriftelijk door onze klantenservice op de hoogte gesteld als er kosten zouden ontstaan. Het aanbod kan dan worden aangenomen of afgewezen. Wij nemen geen ongefrankeerde bestellingen van reserveonderdelen aan! Deze rechtstreekse service wordt verleend in de landen Duitsland, de Benelux, Oostenrijk, Frankrijk en Groot-Brittannië. Bestellingen van reserveonderdelen in de overige landen worden afgewikkeld via de betreffende distributeurs. Neem hiervoor contact op met uw verkoper.

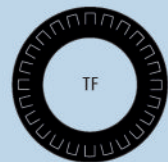
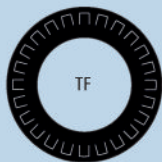
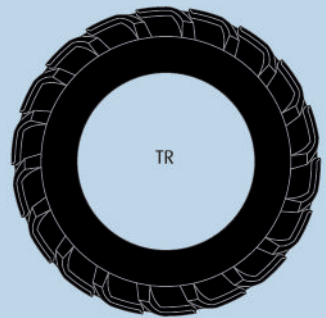
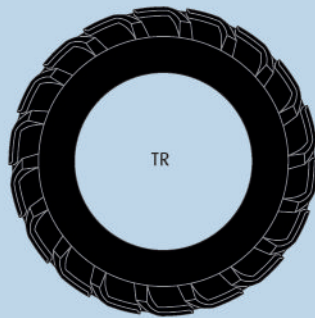
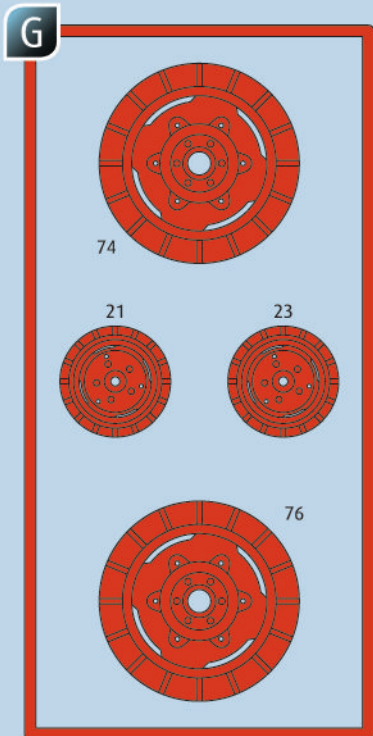
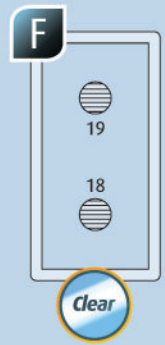
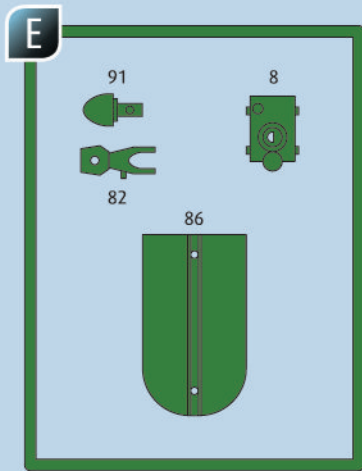
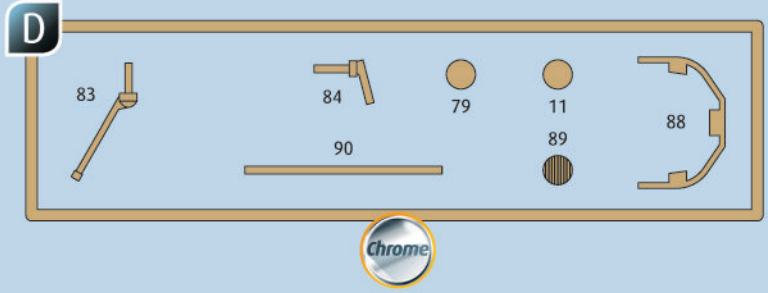
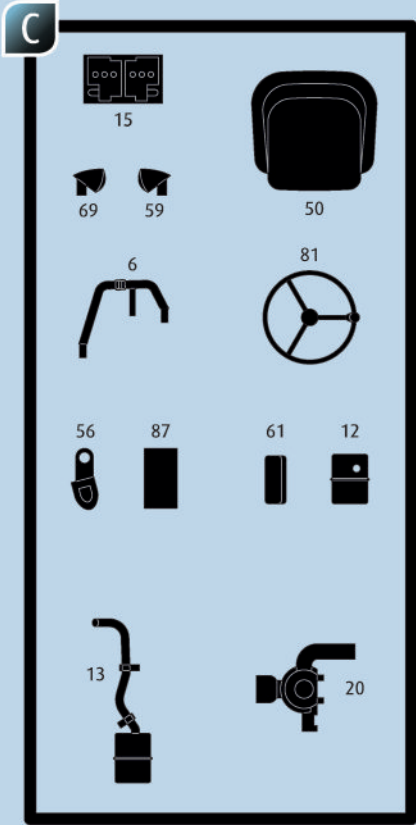

1

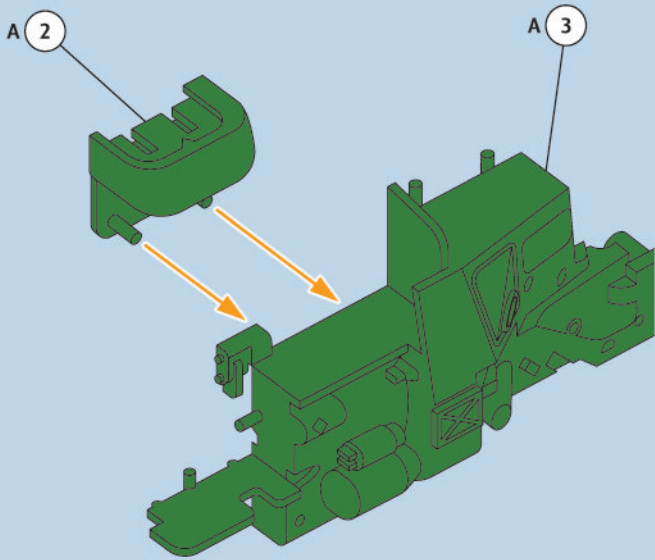

2

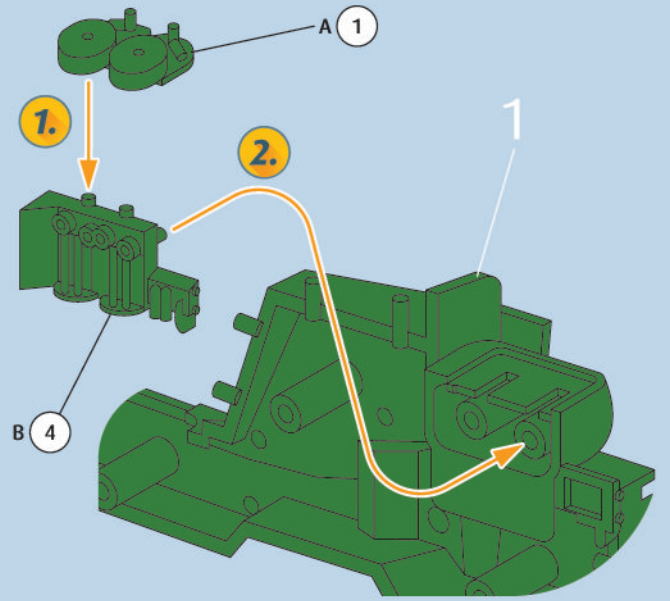

3

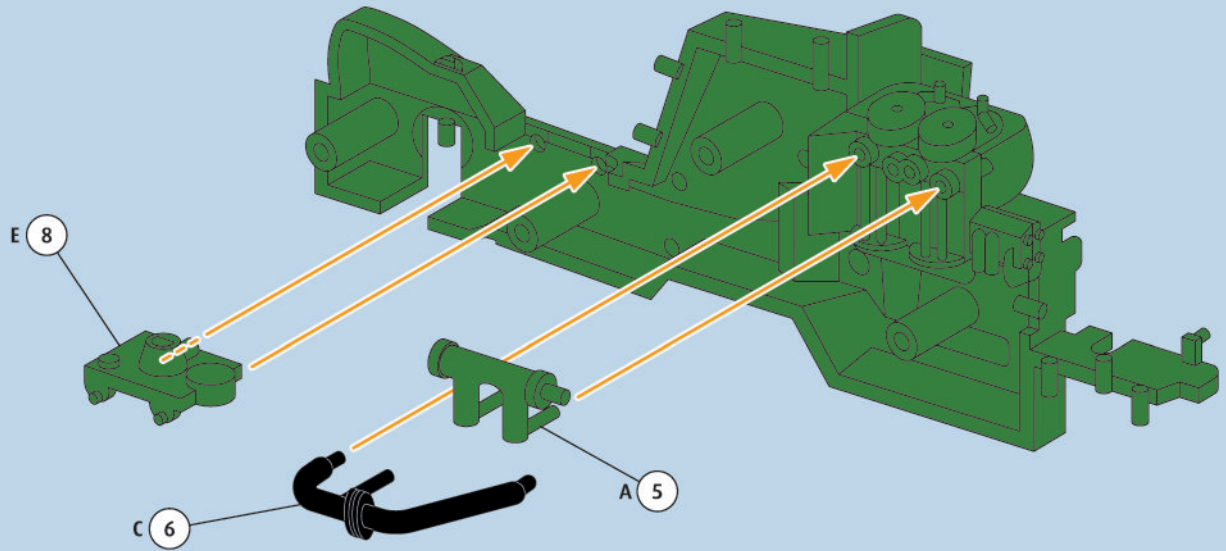

4

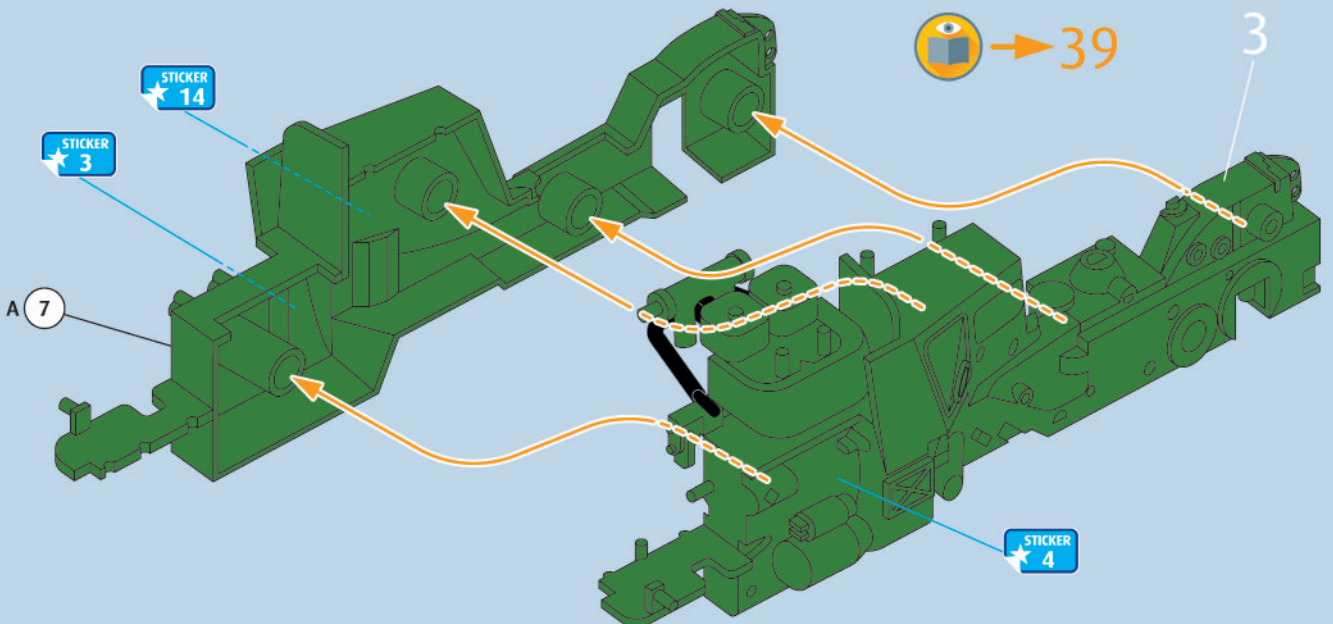



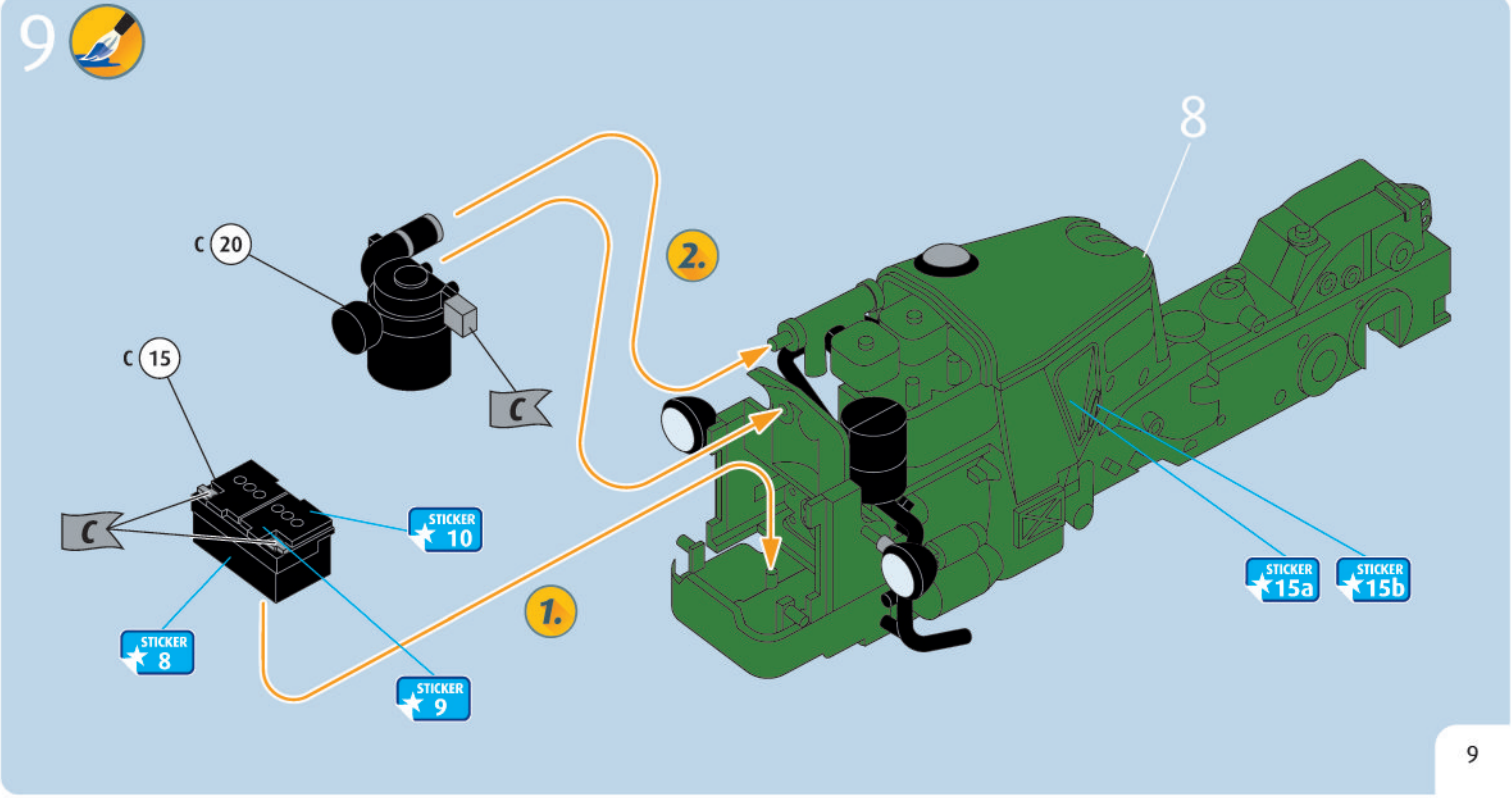
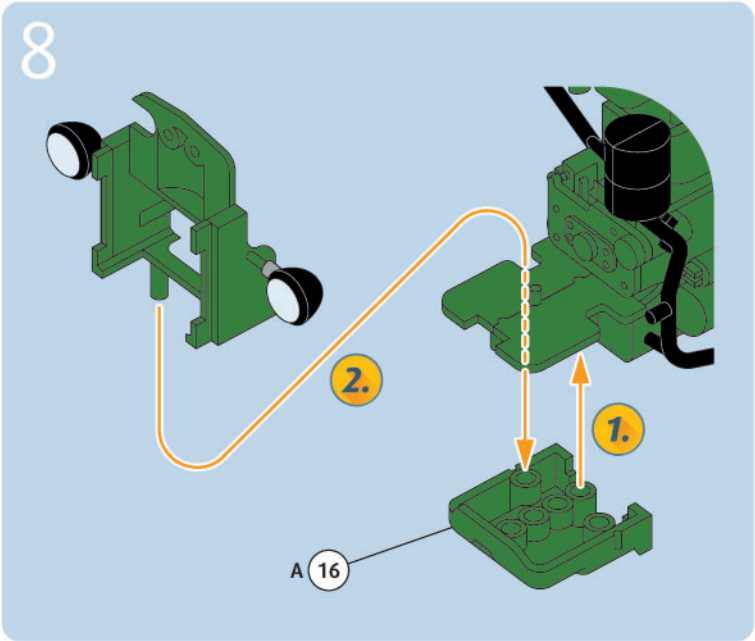
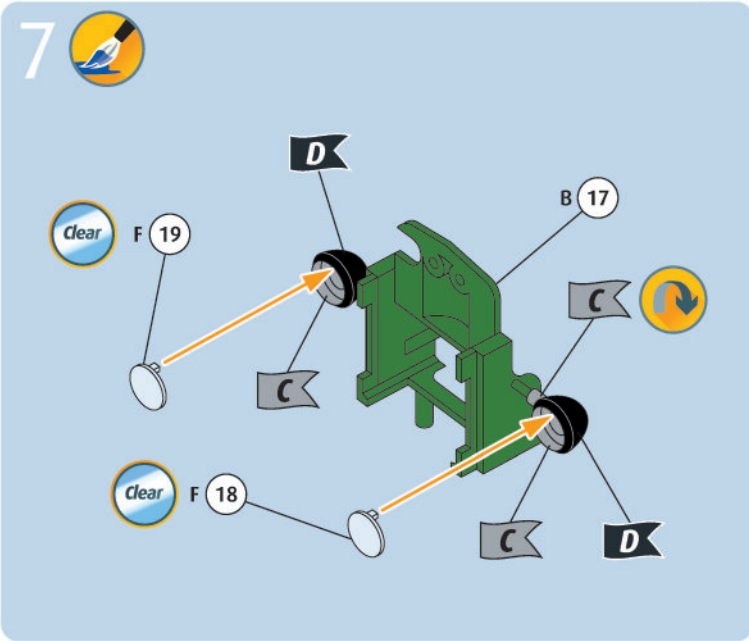
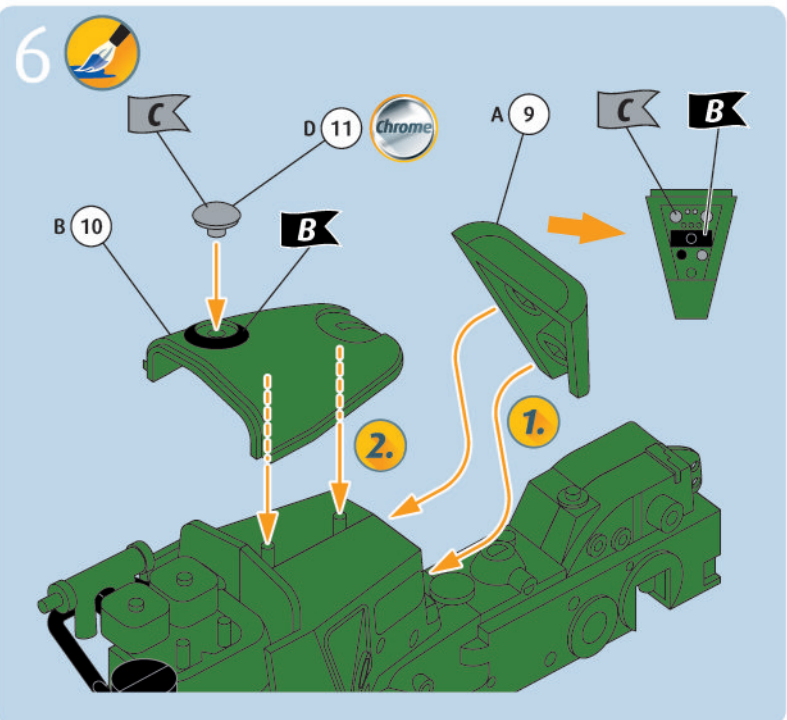
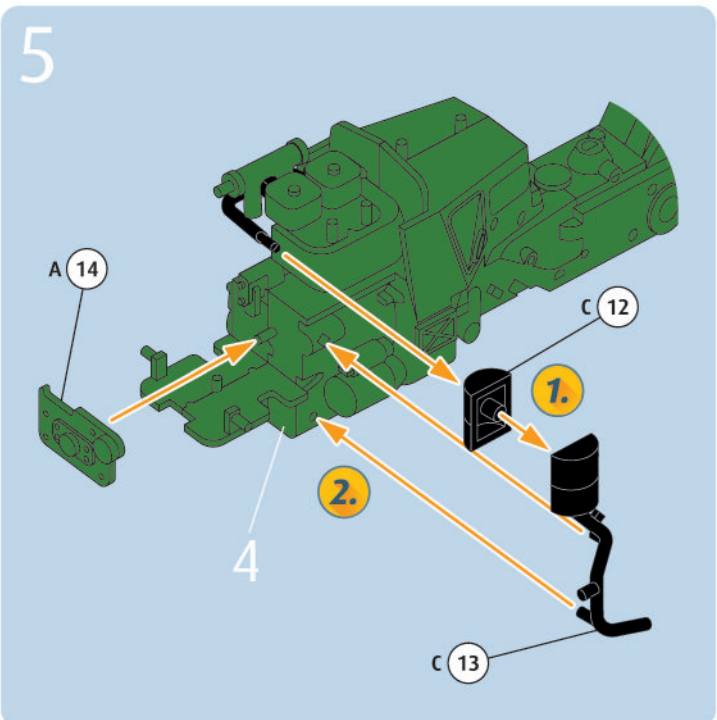



14

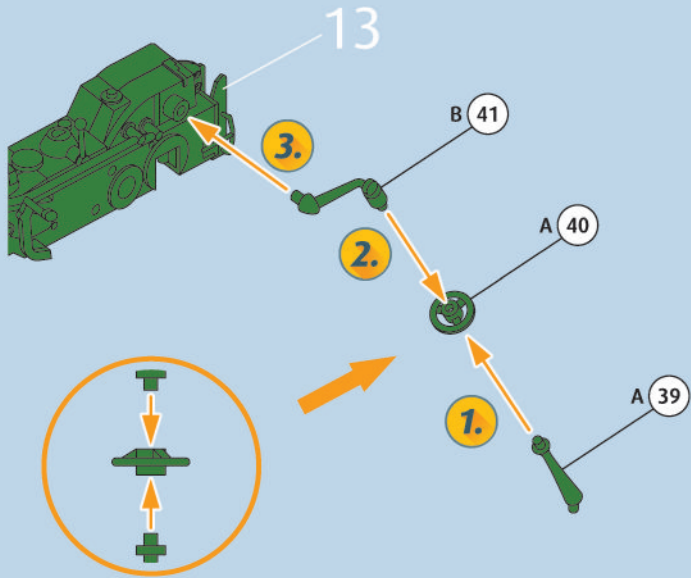

15

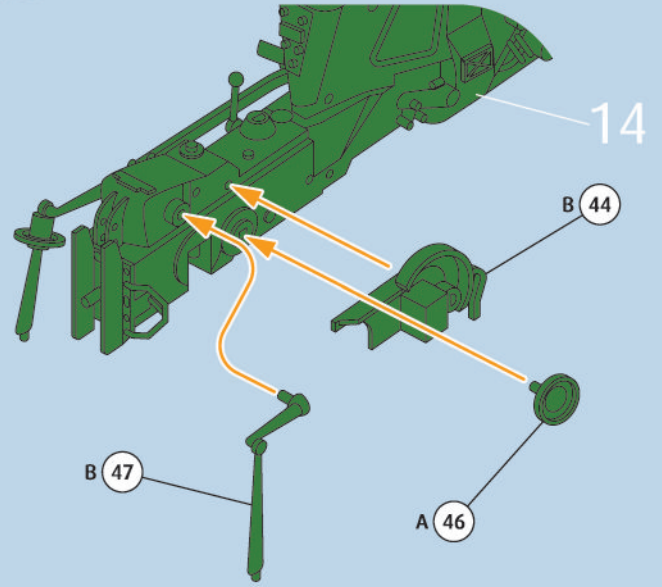

16 

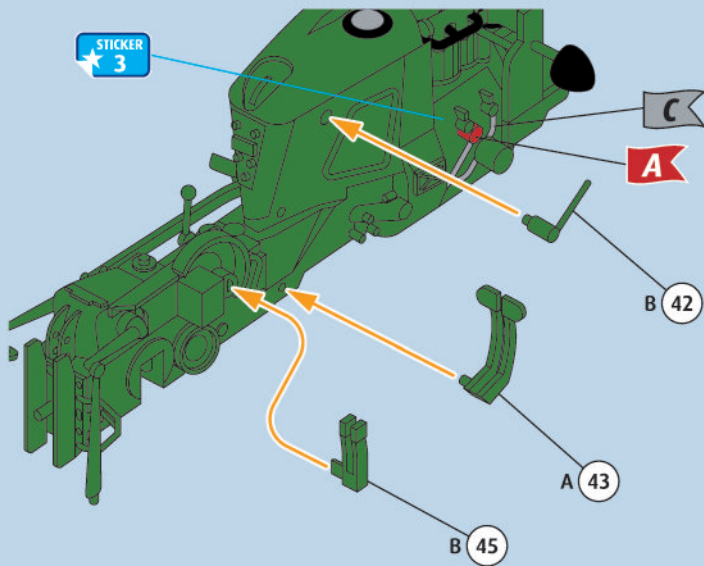

17 

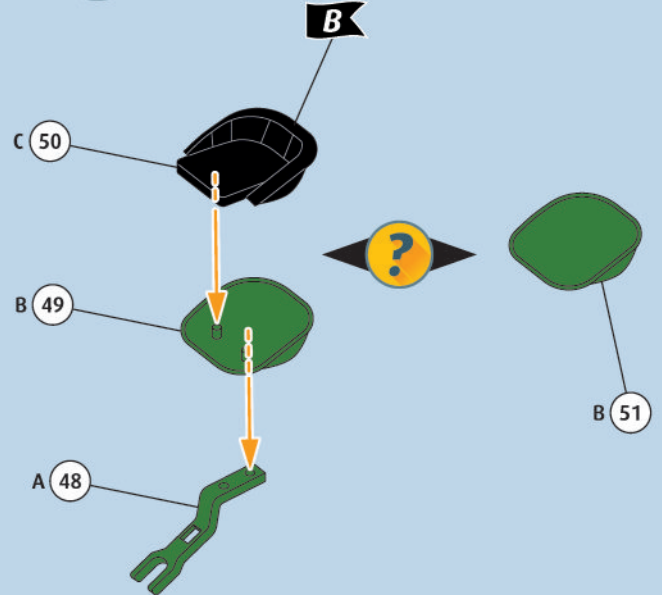

18 

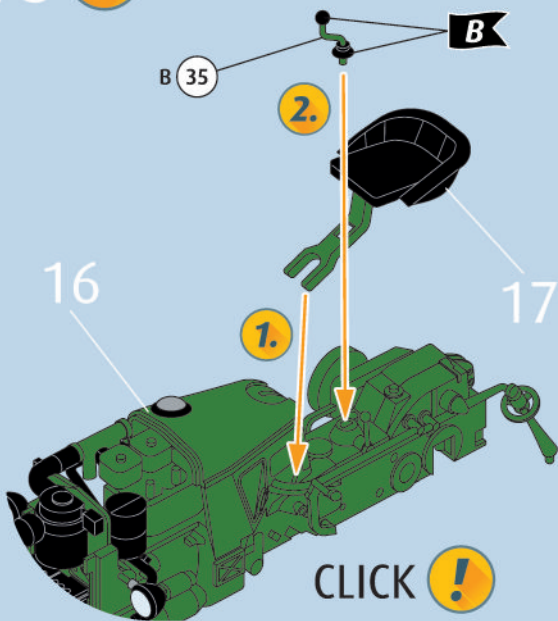

19 

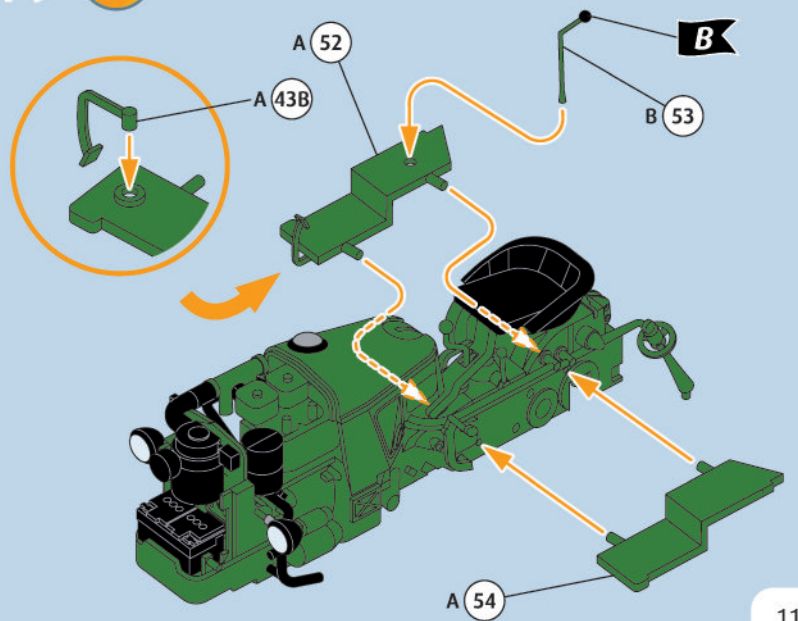

20

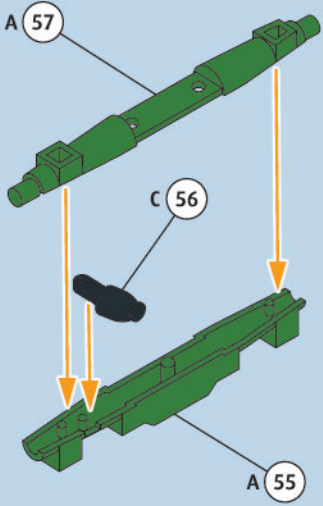

21

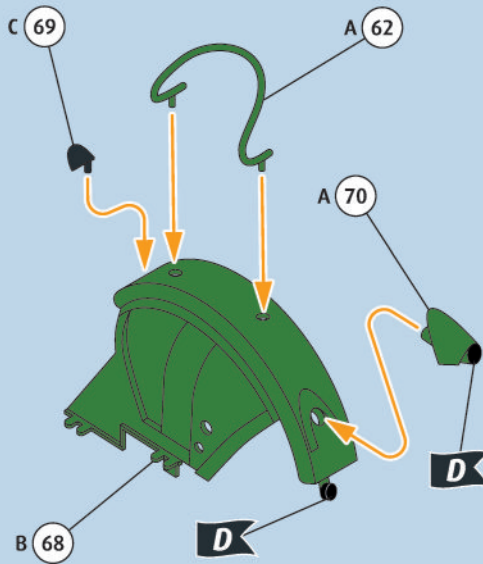

22

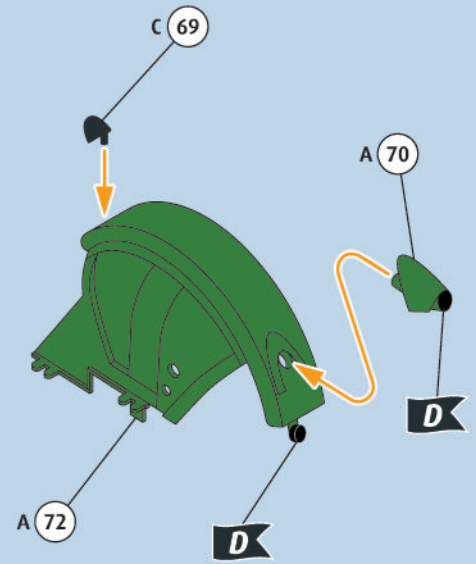

23

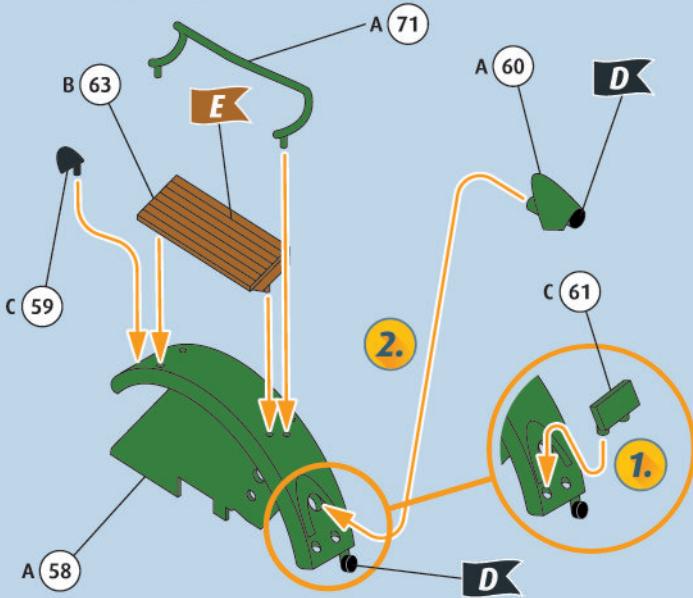

24

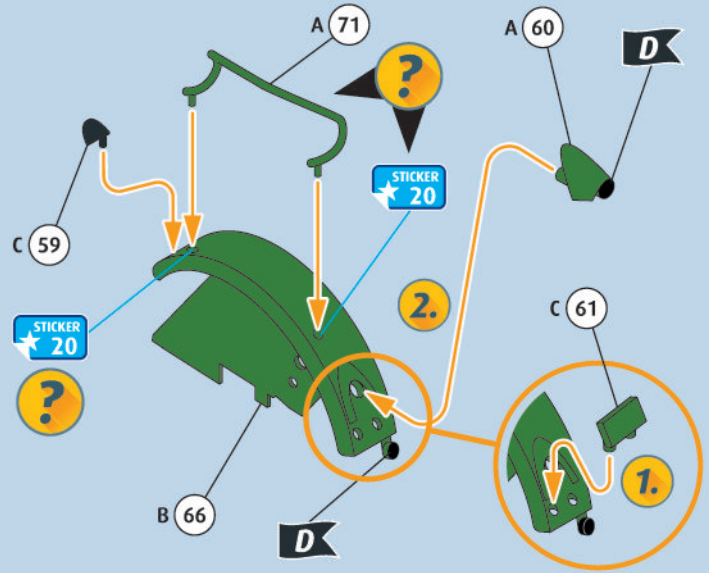

25

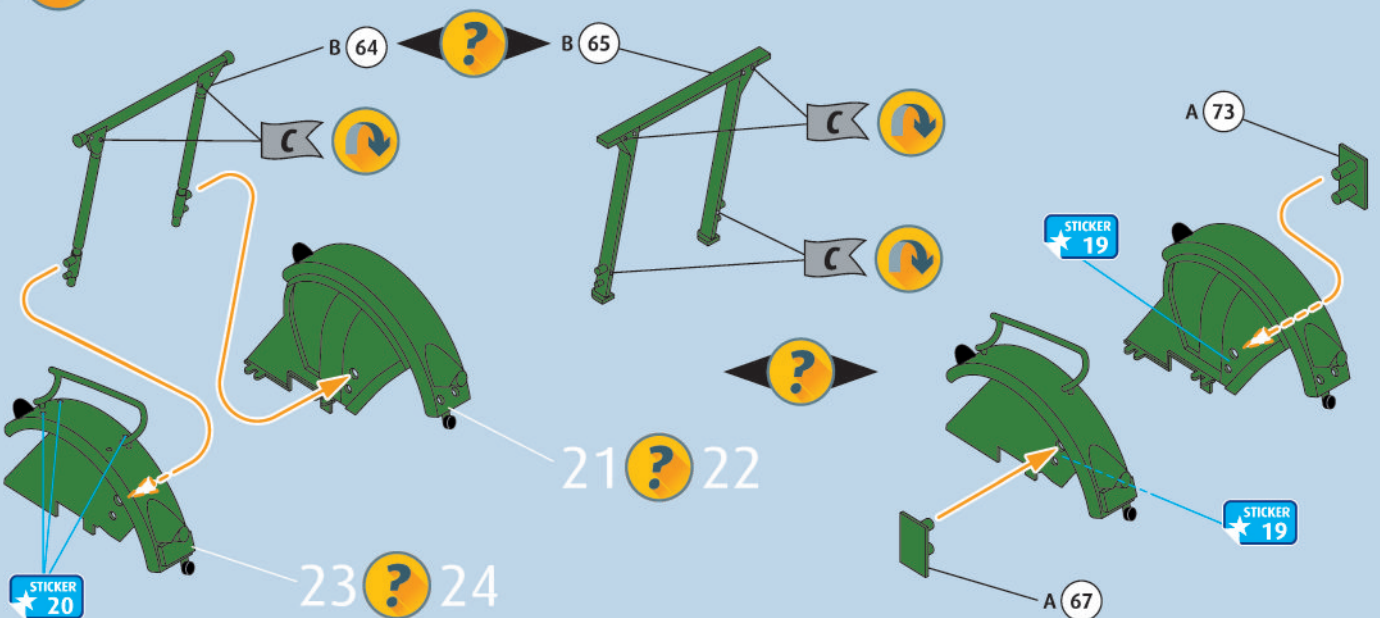

26

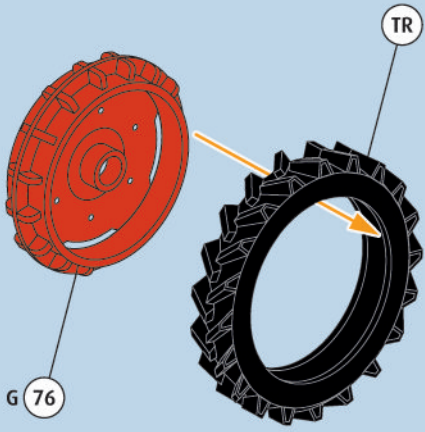

27

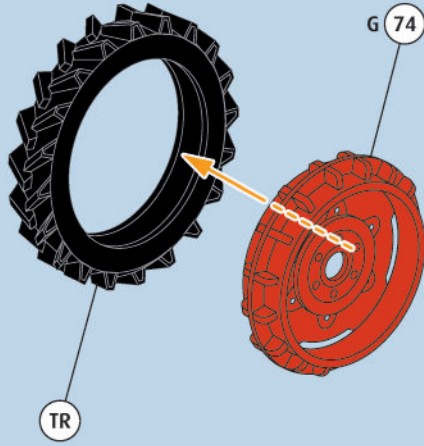

28

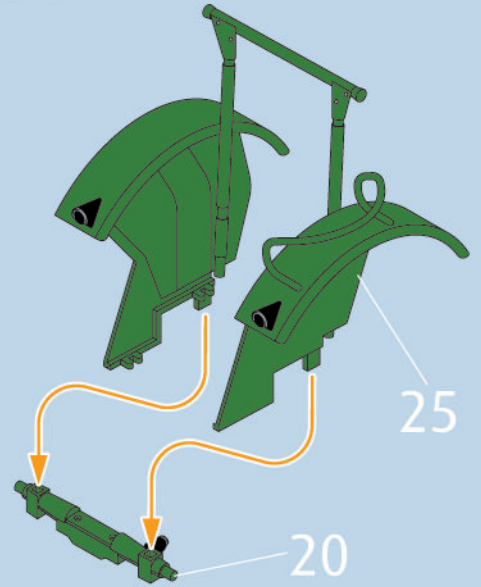

29

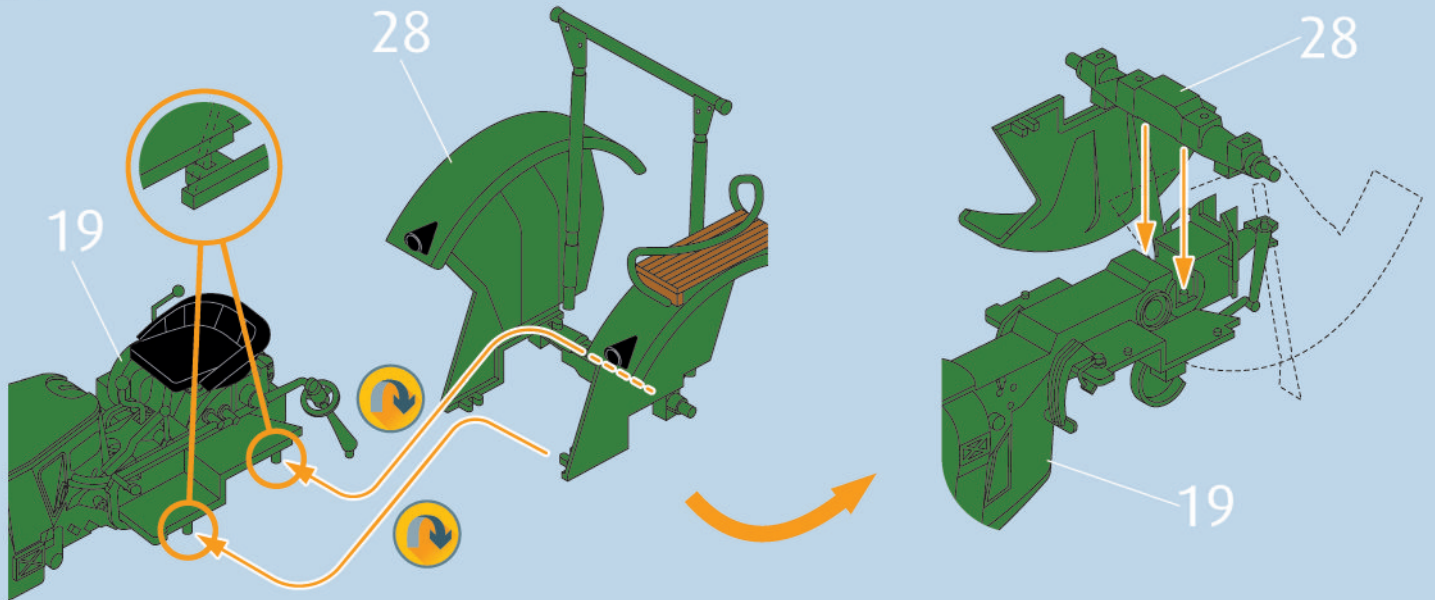

30

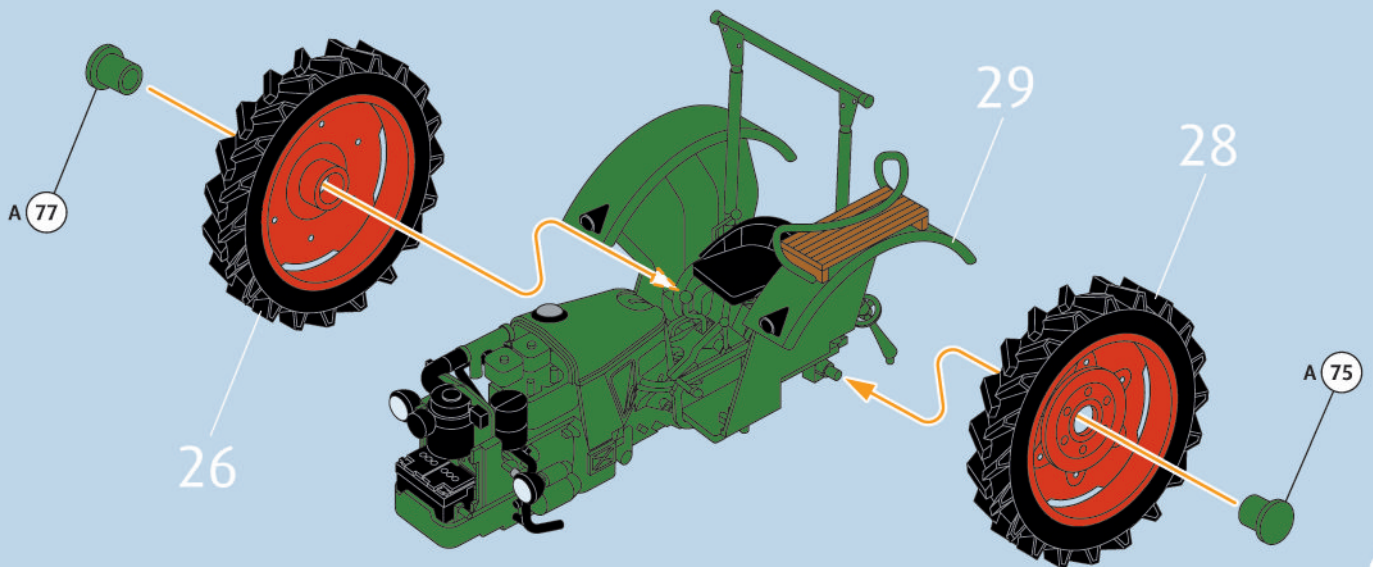

31

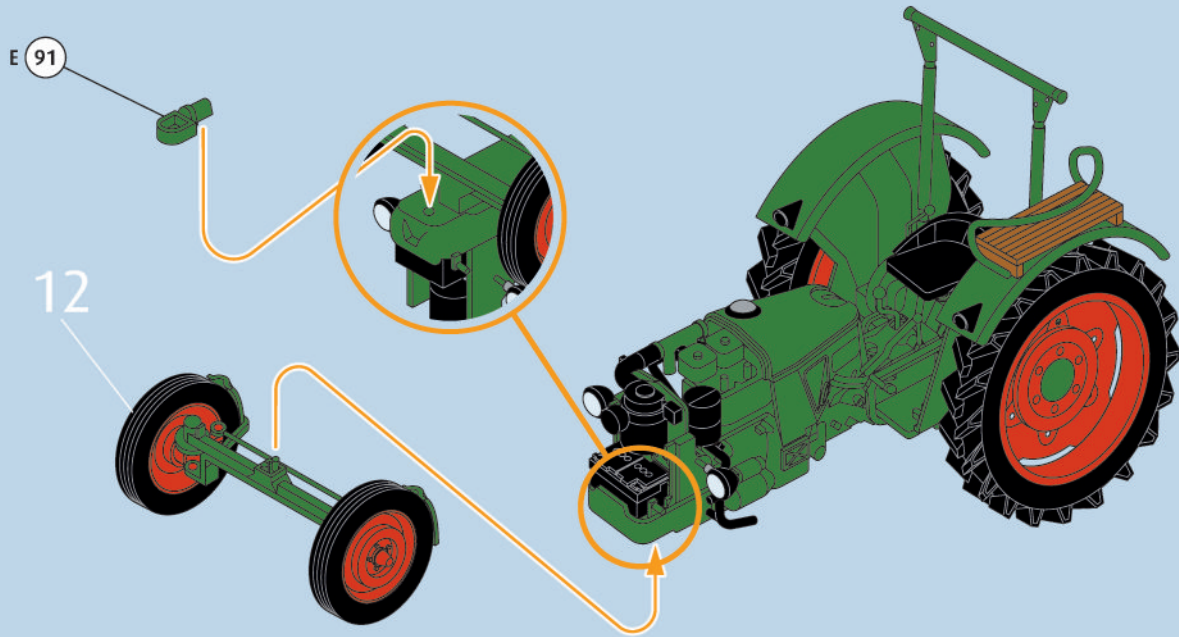

32

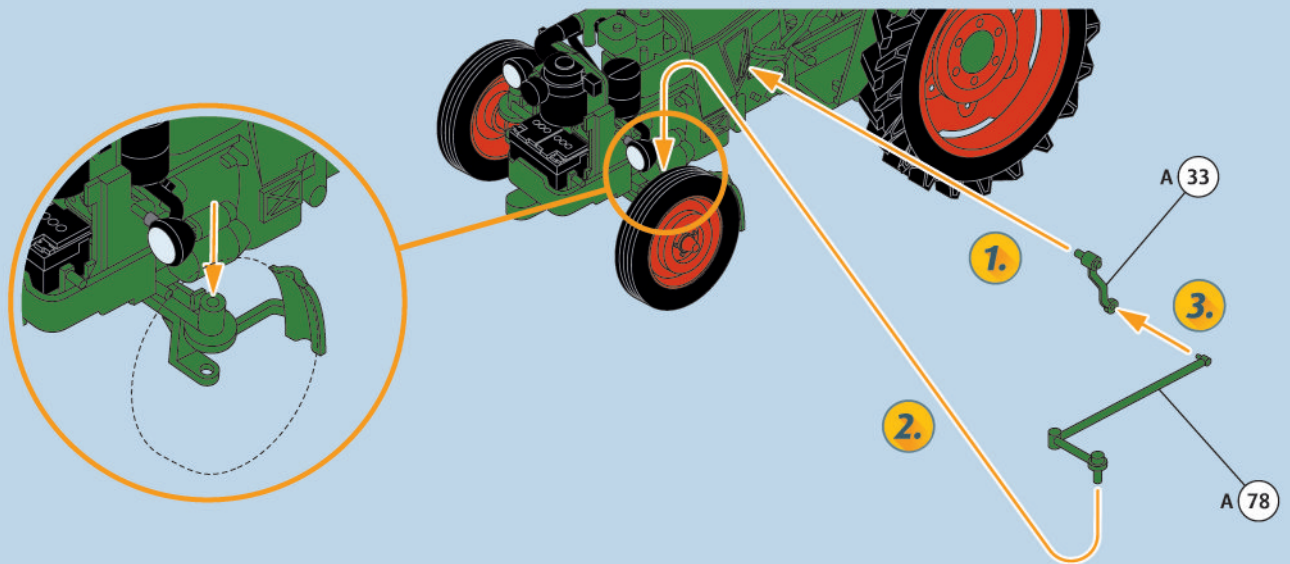

33

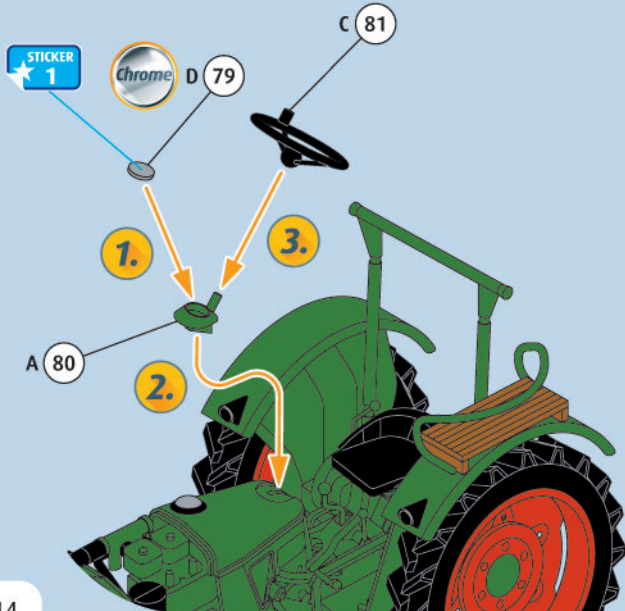

34

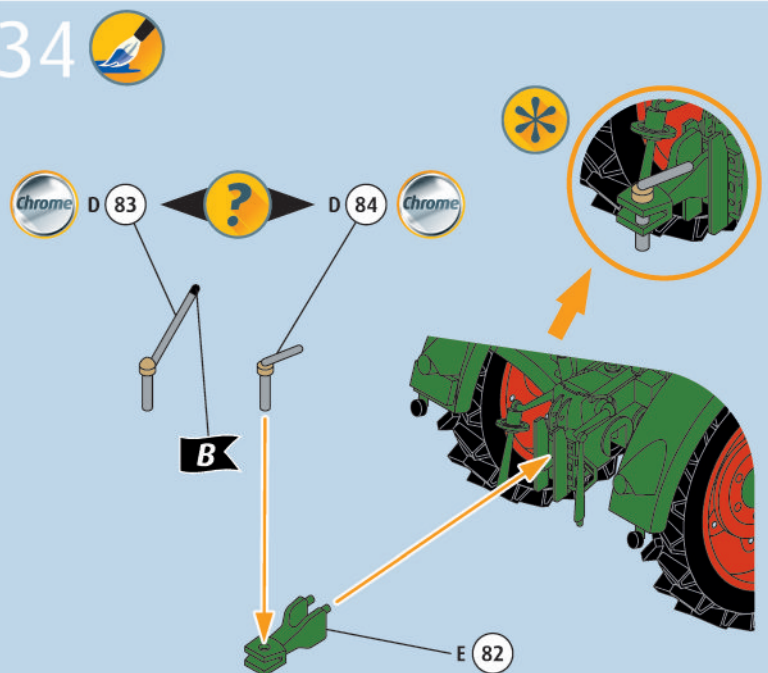

# 35

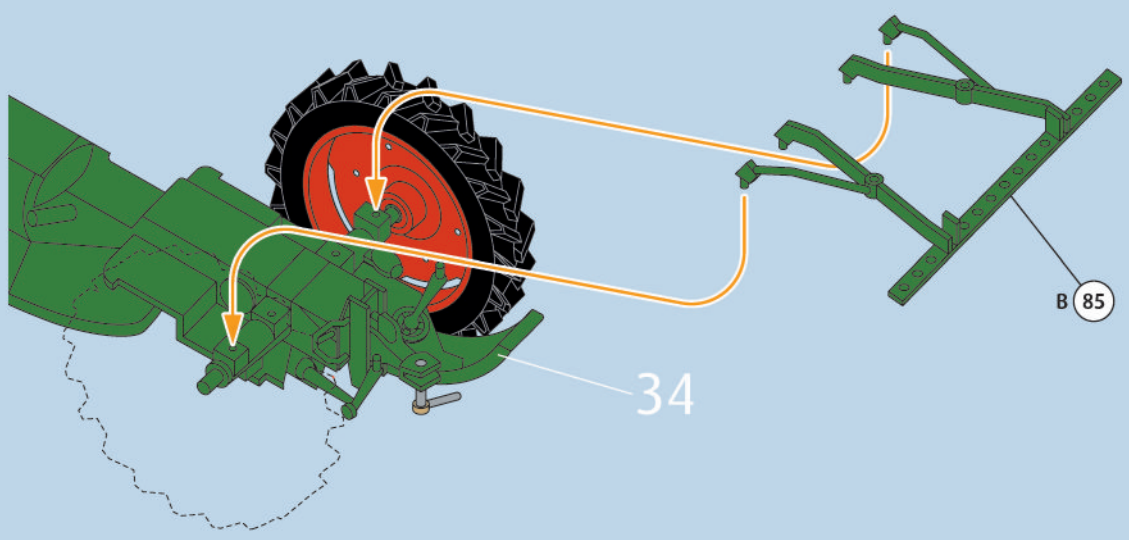

# 36

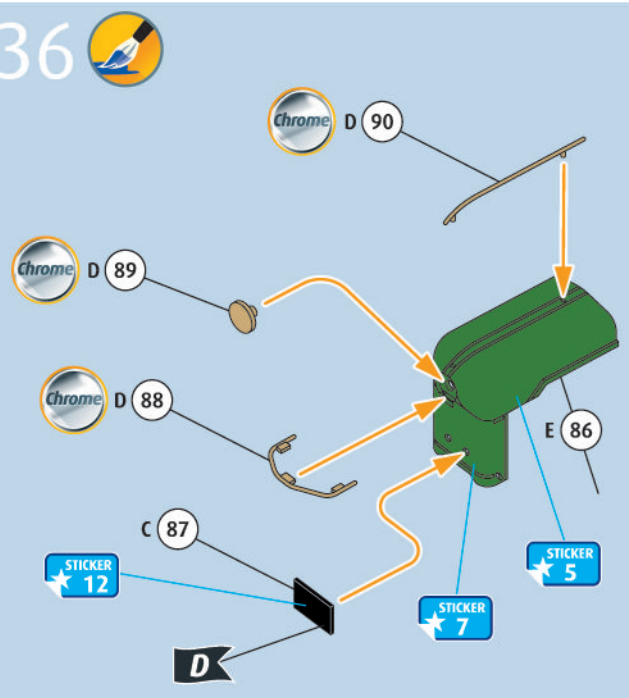

# 37

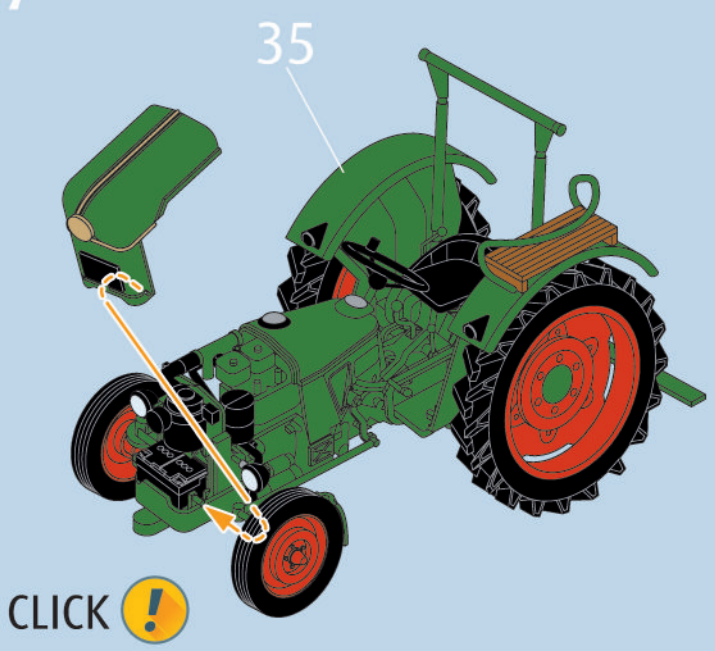

# 38

