

WIZARDING
WORLD

Harry Potter™



forbidden

3D
PUZZLE

CONTACT
IF YOU HAVE

TRY
TION

YOU-KNOW-WHO'S
MASTER

273
PIECES

8+

58 × 17 × 21.1 cm
22.8" × 6.7" × 8.3"



DIAGON ALLEY™ SET |

3D Puzzle

Gringotts Bank™

A

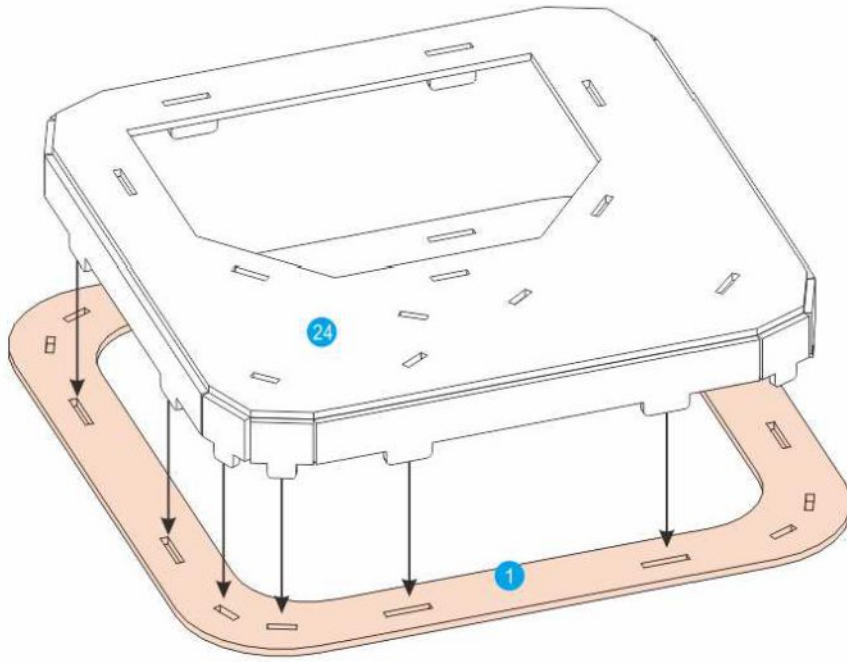

B

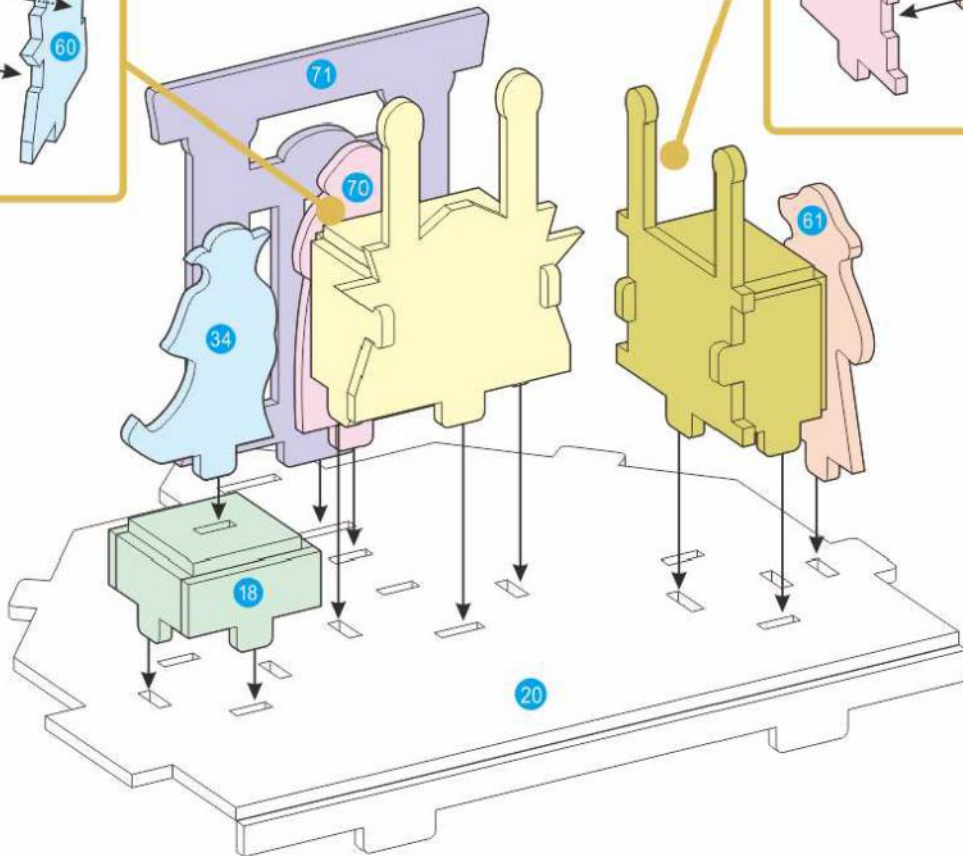
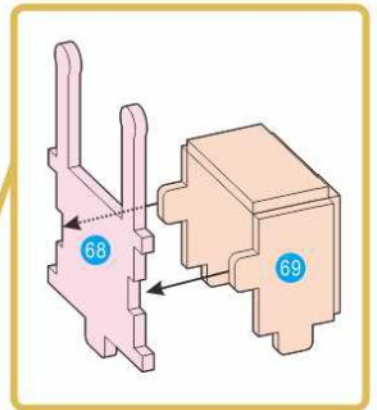
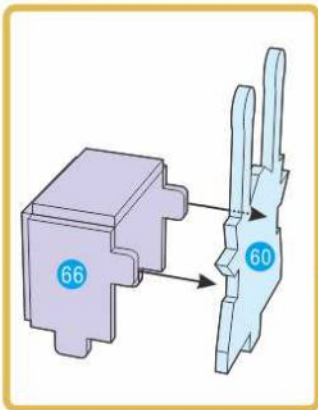

C

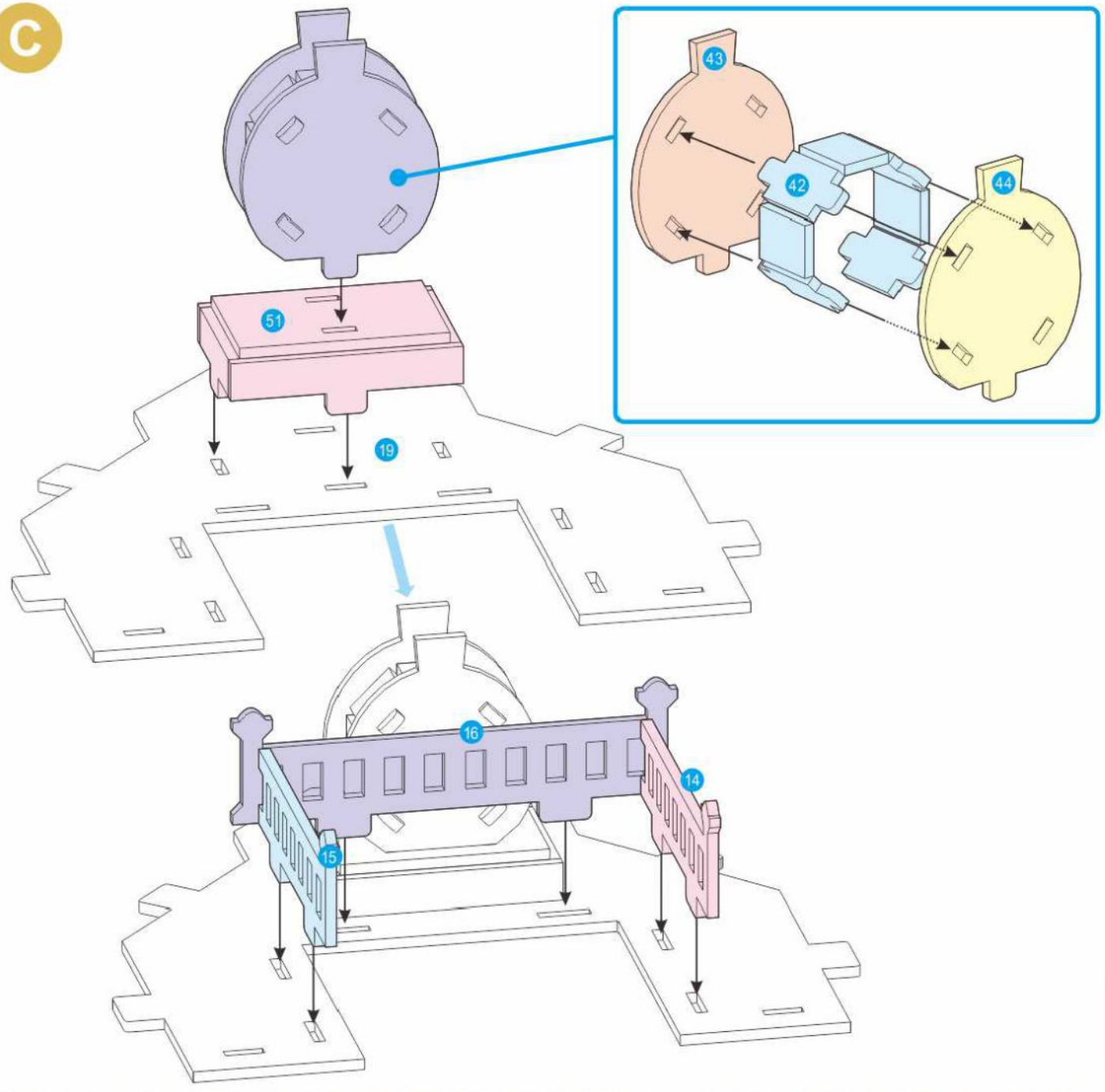

D

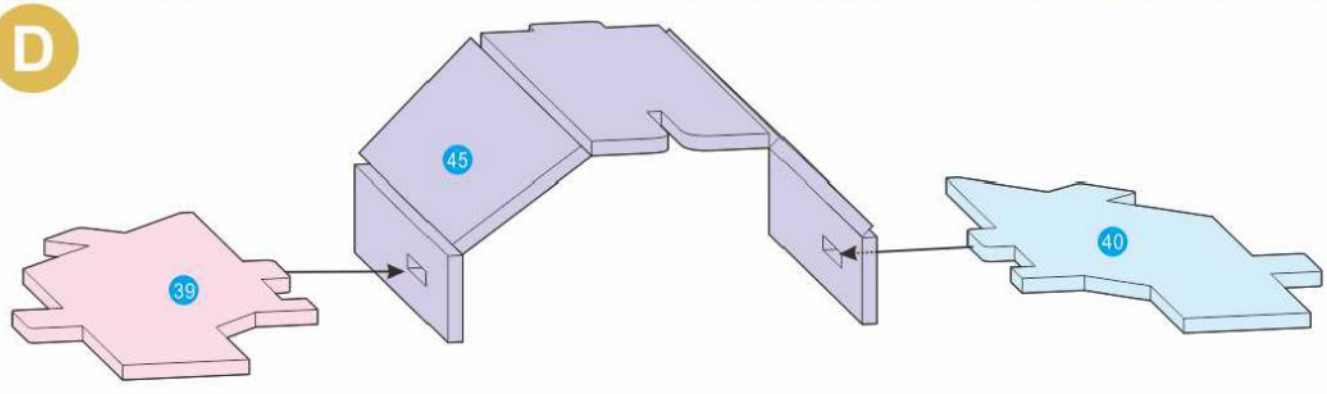

E

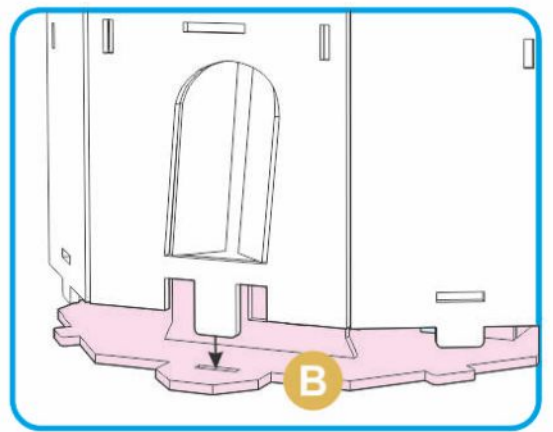
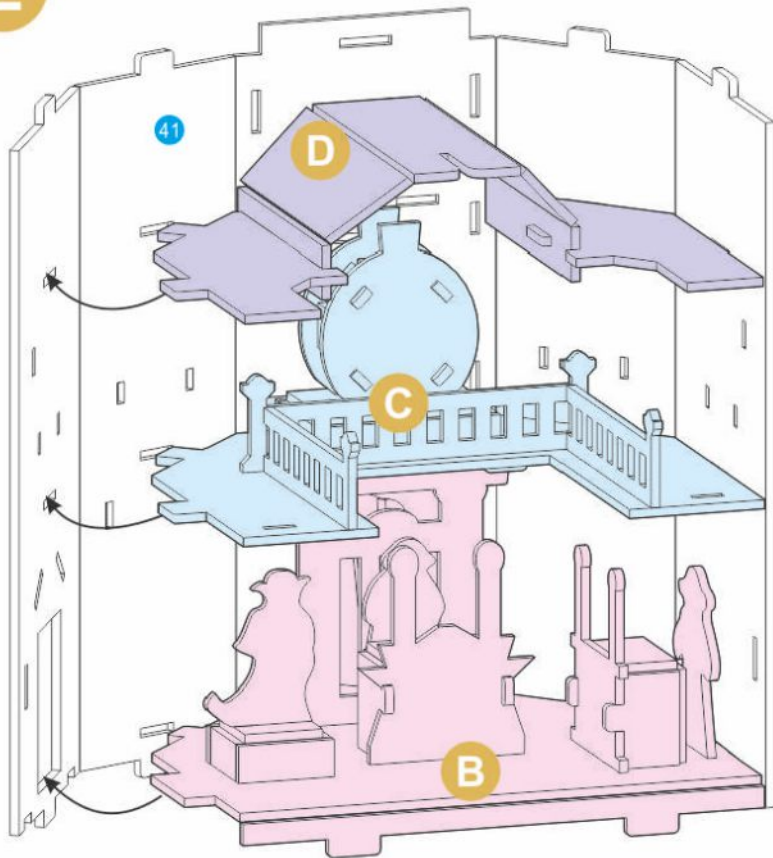

F

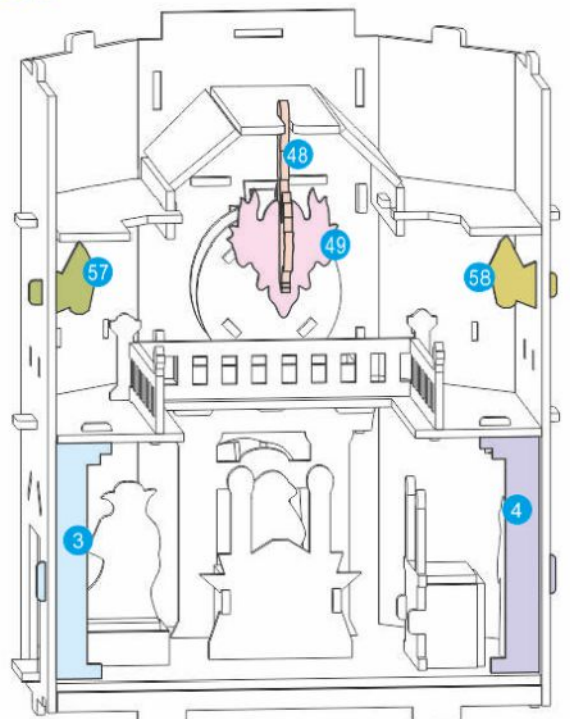
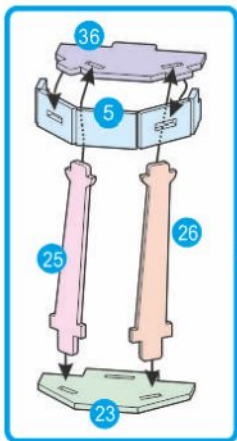
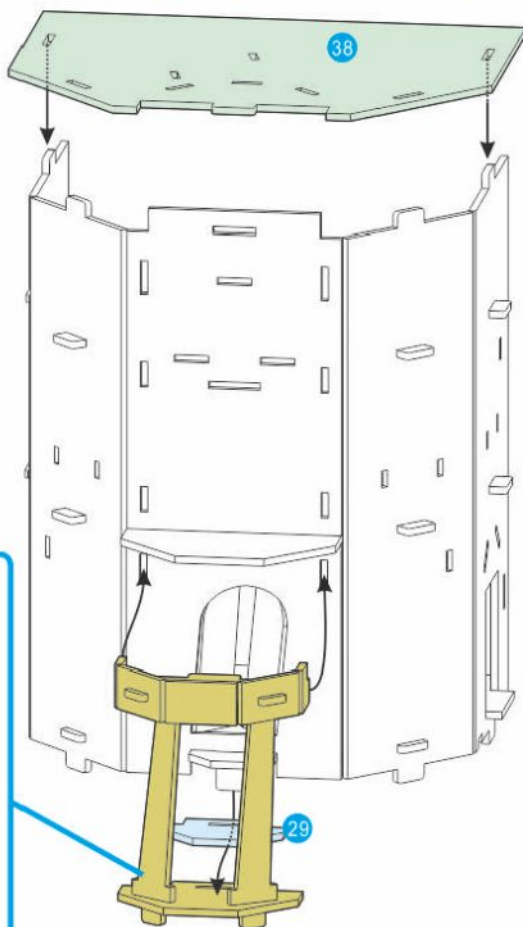

G

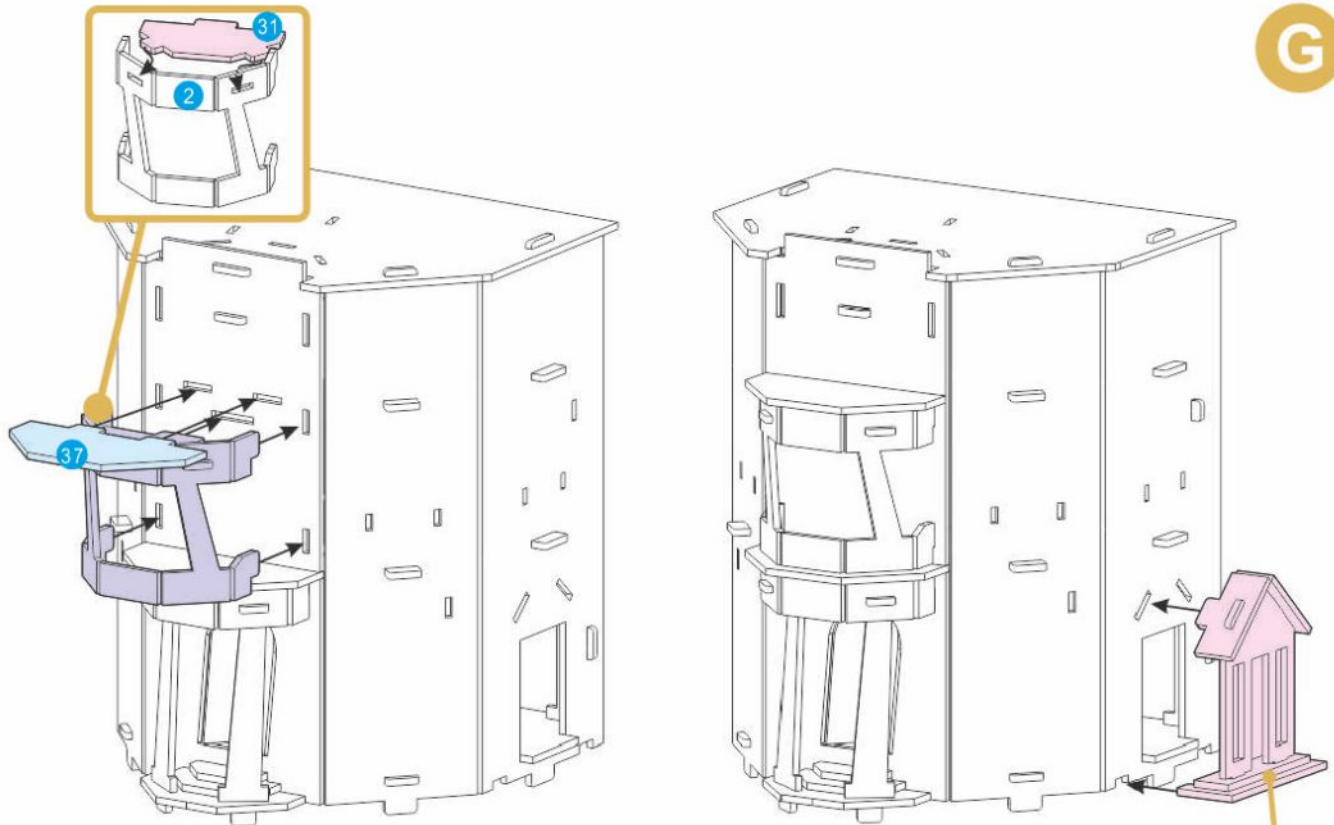

H

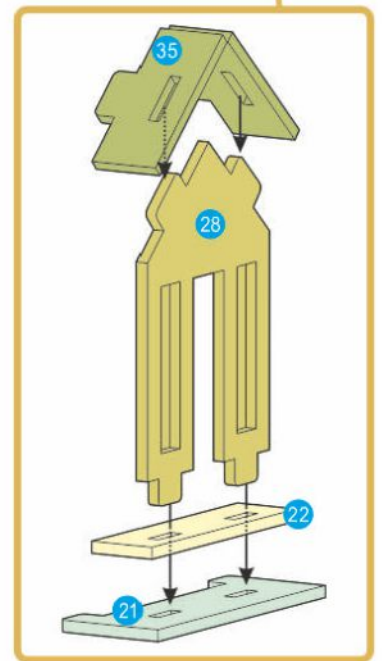
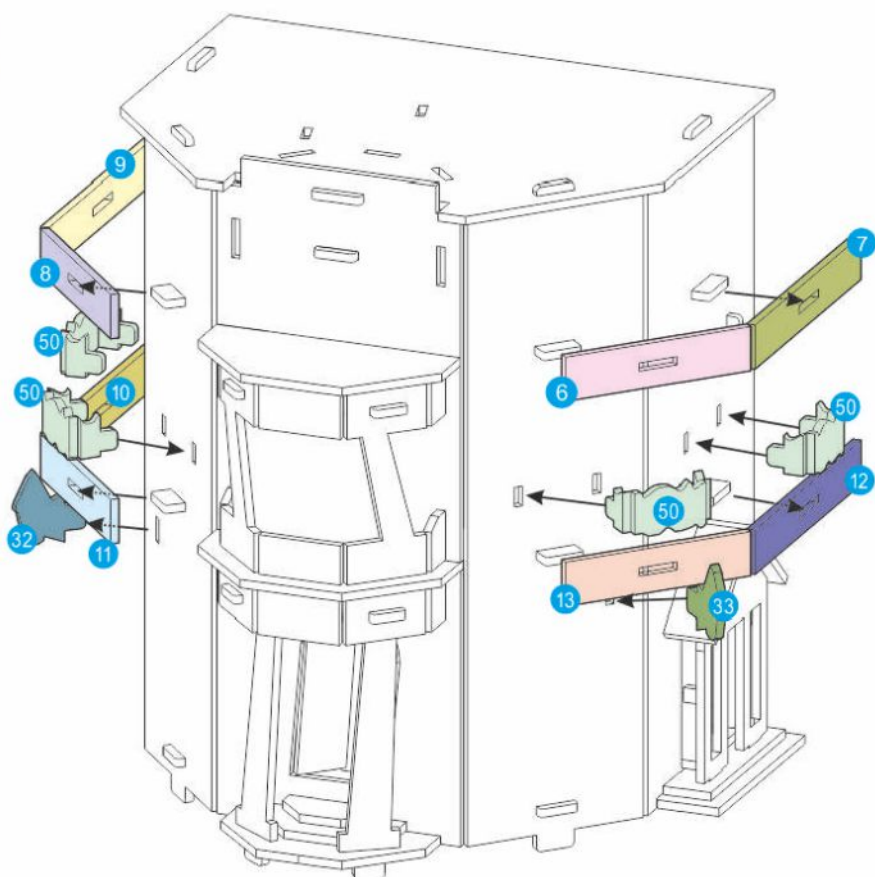

I

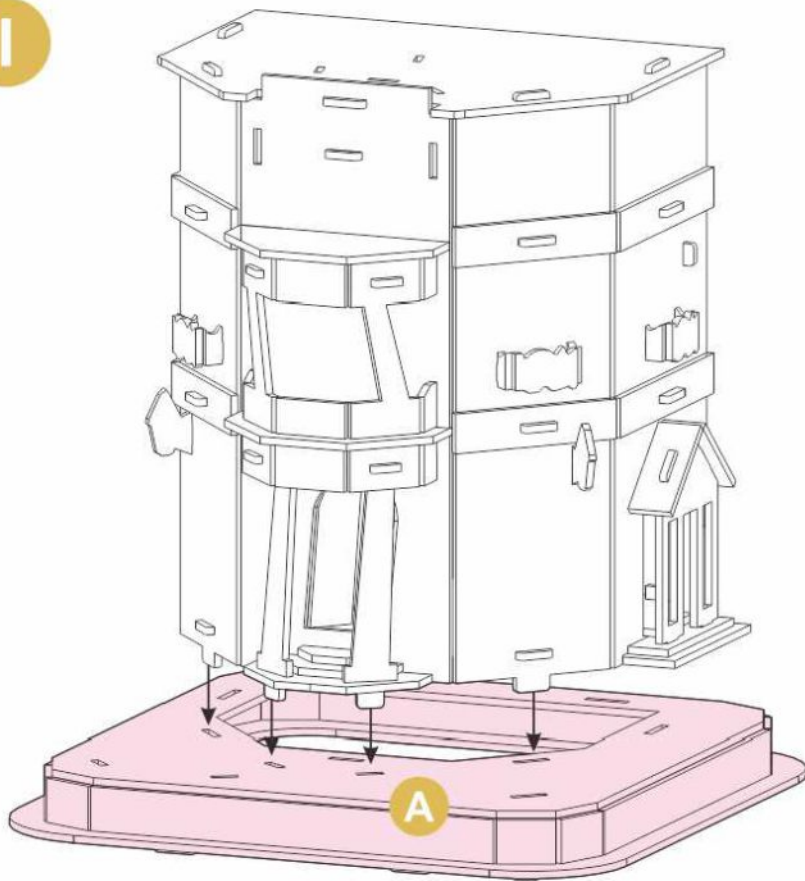

J

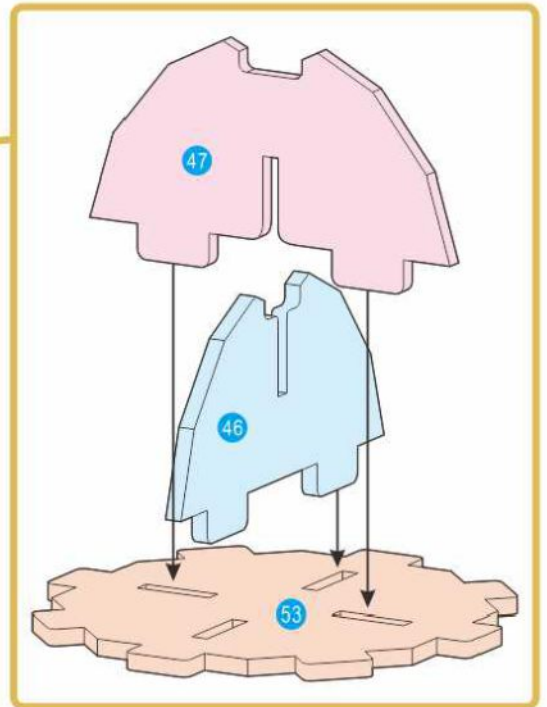
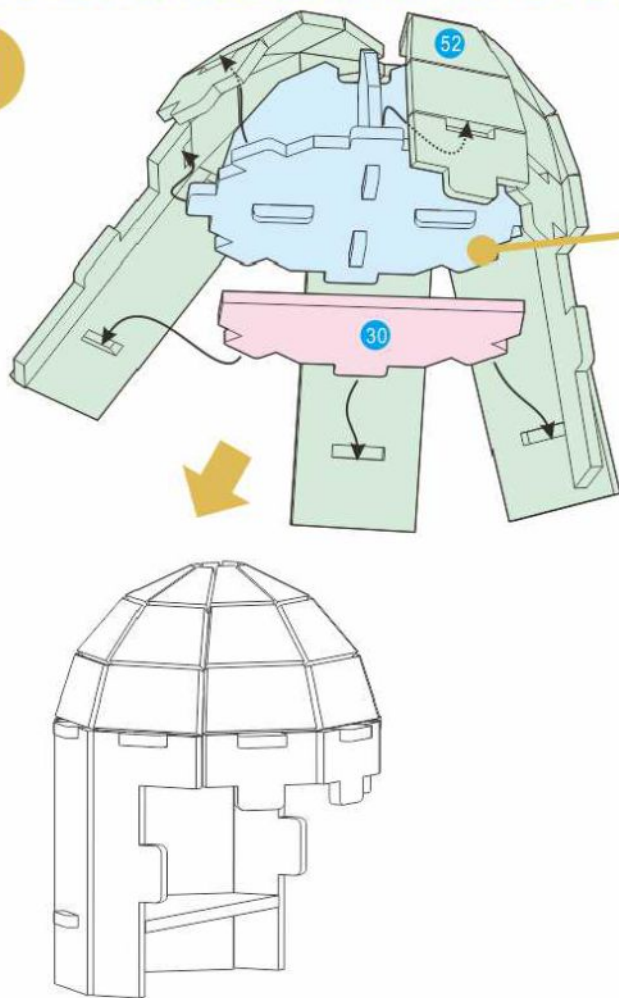

K

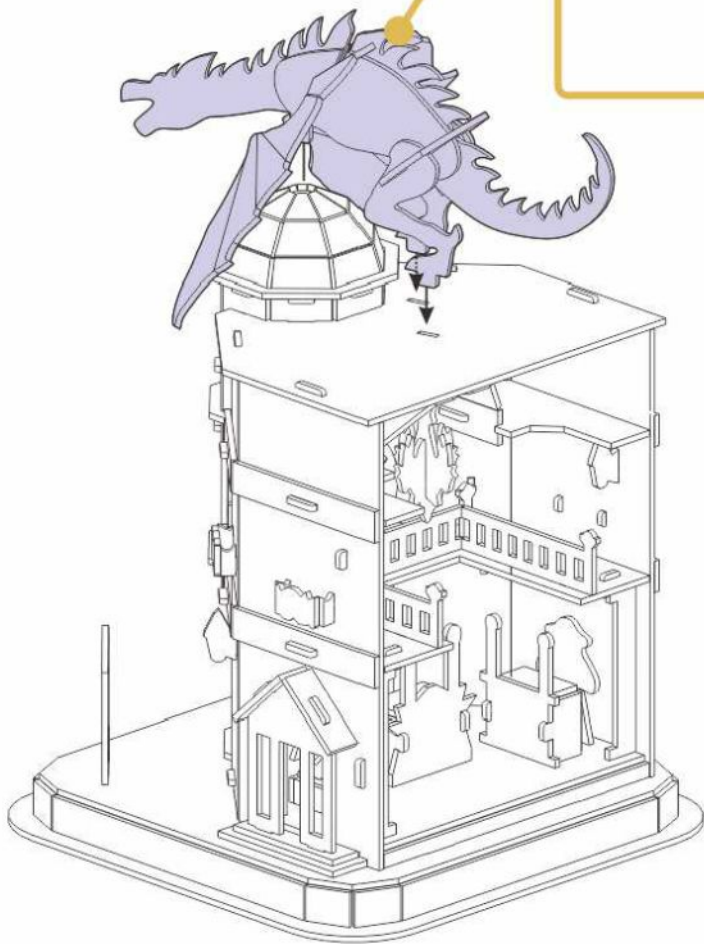
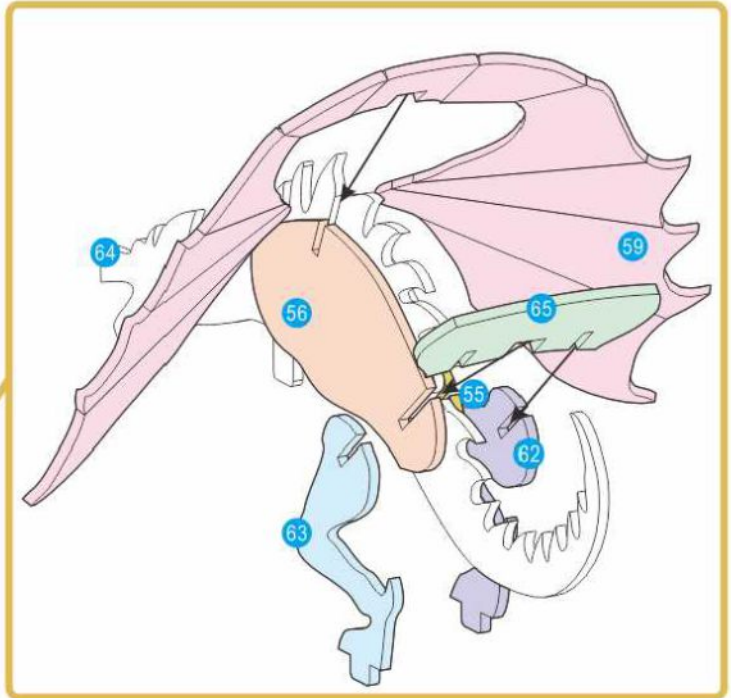
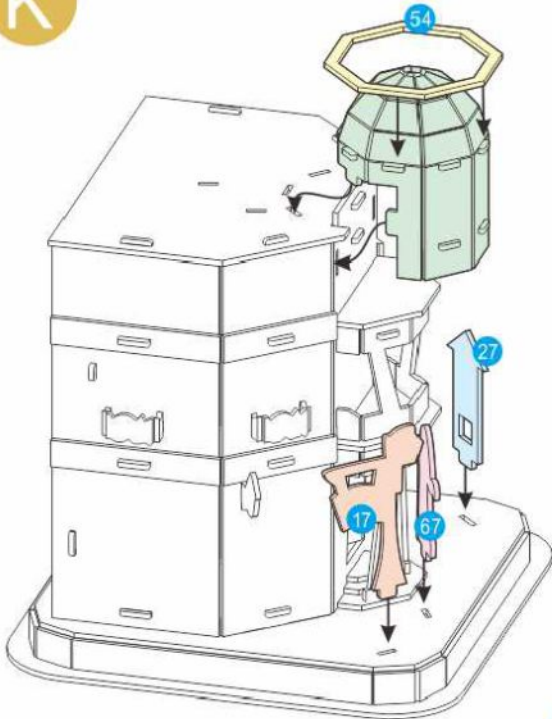

Ollivanders Wand Shop™

A

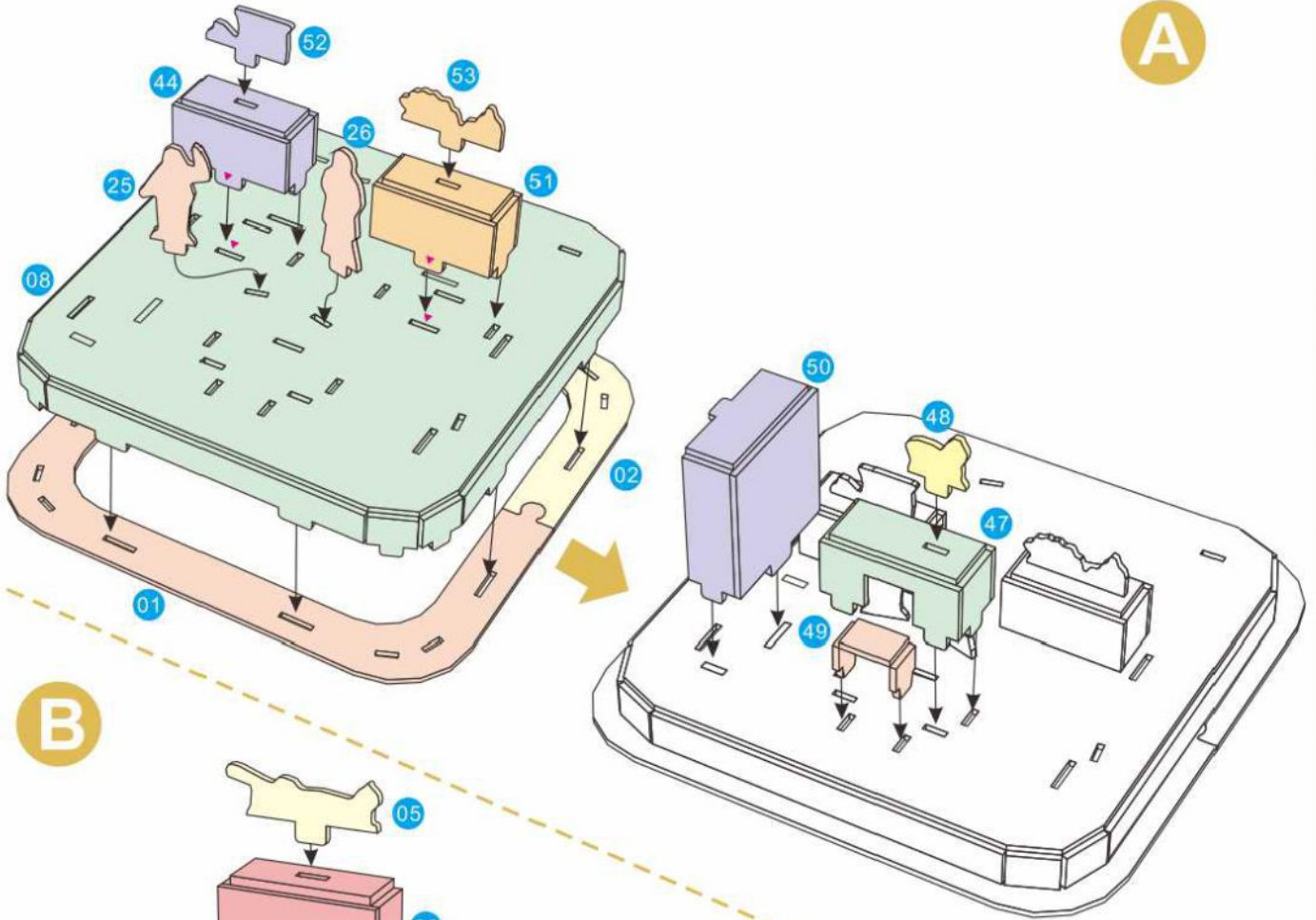

B

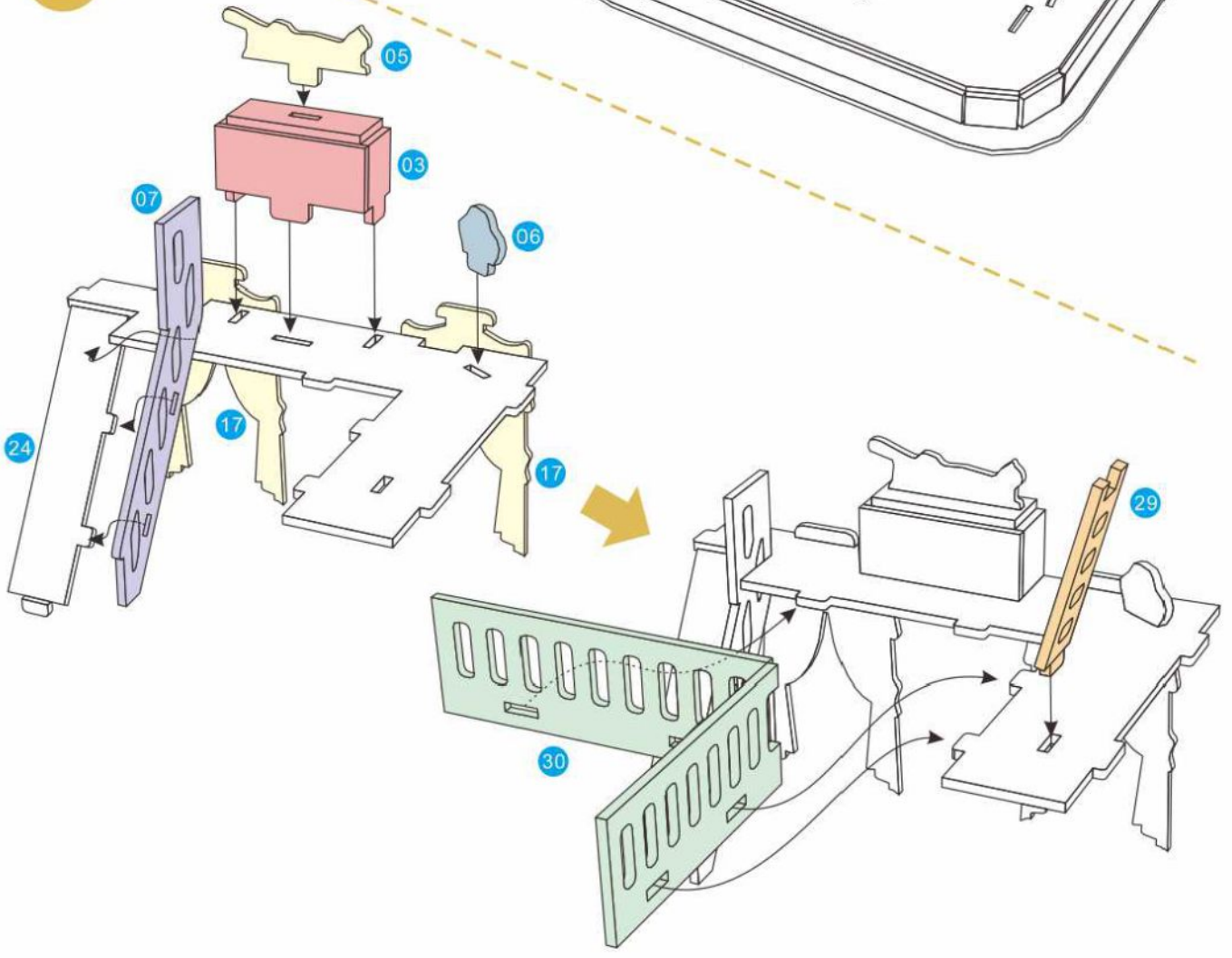

C

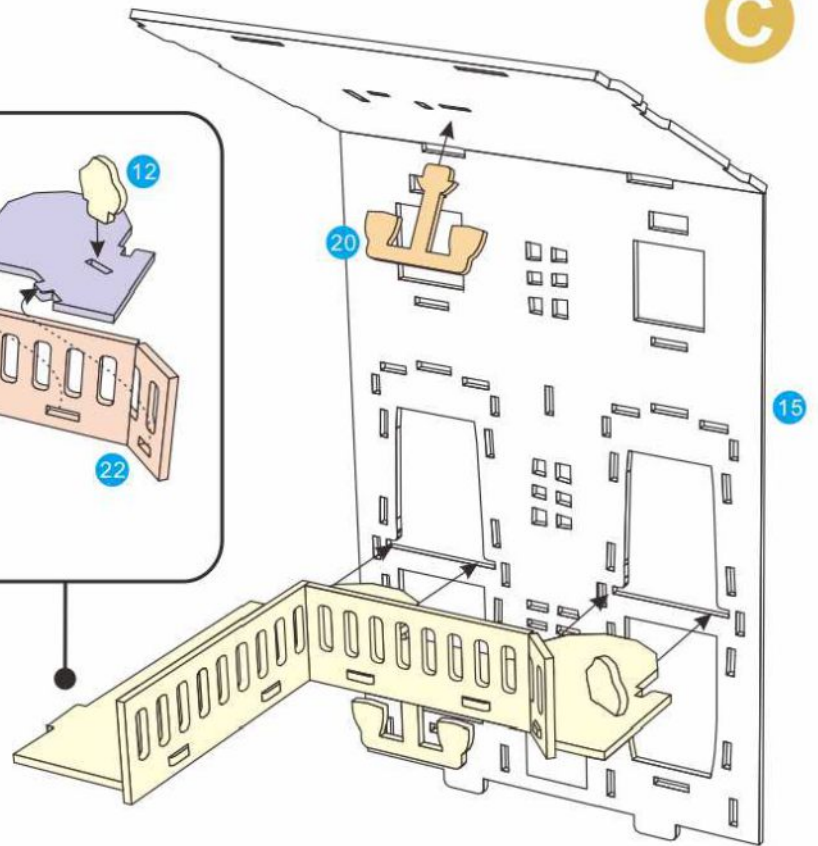
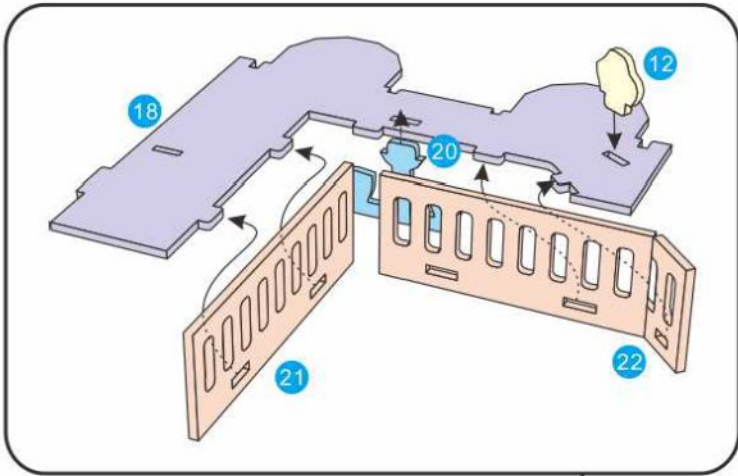

D

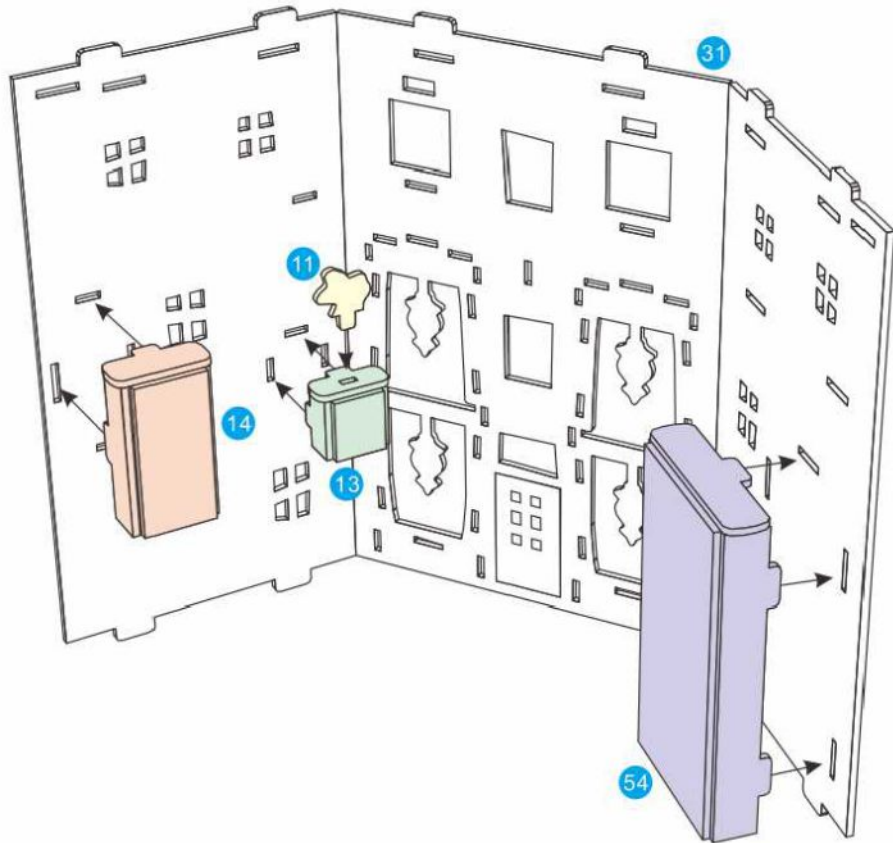

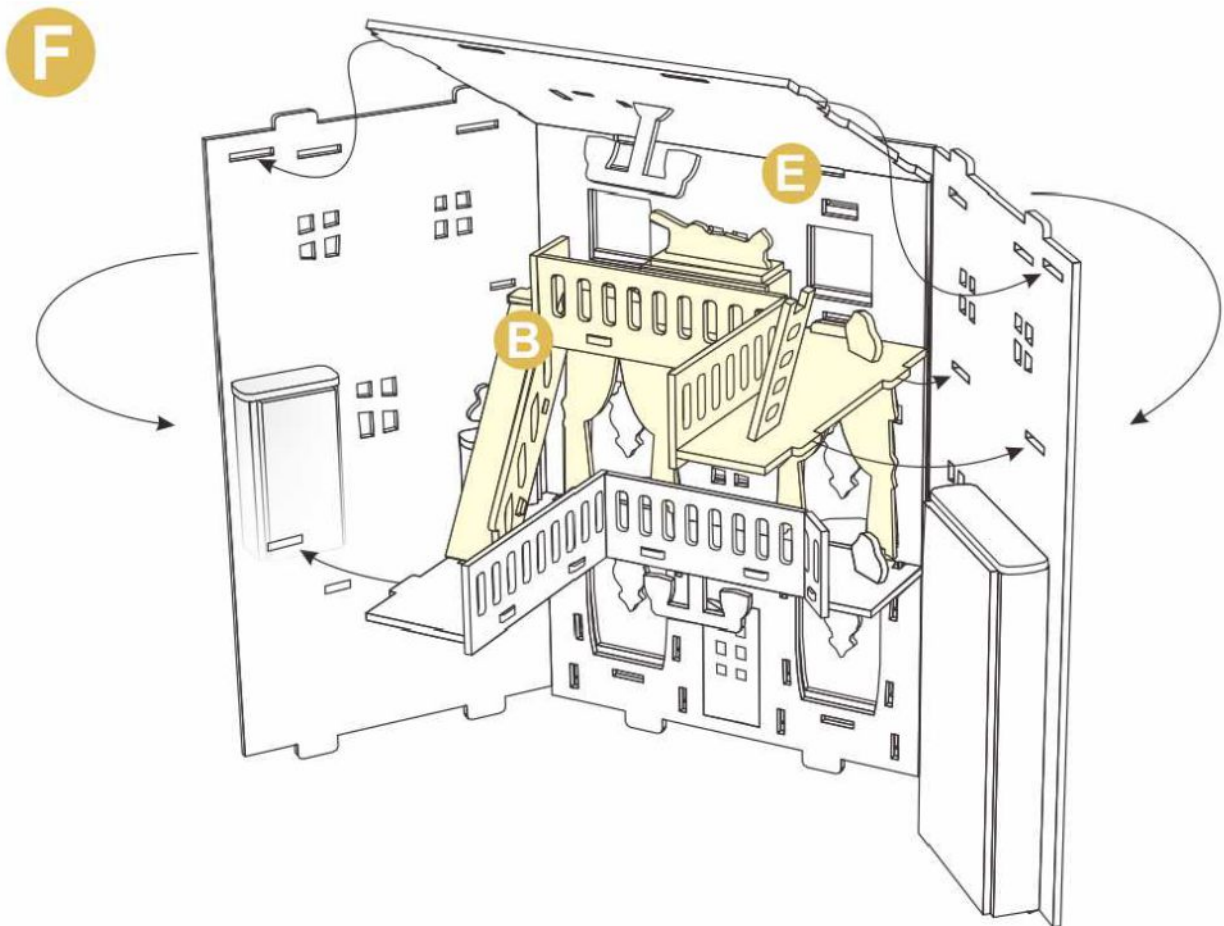
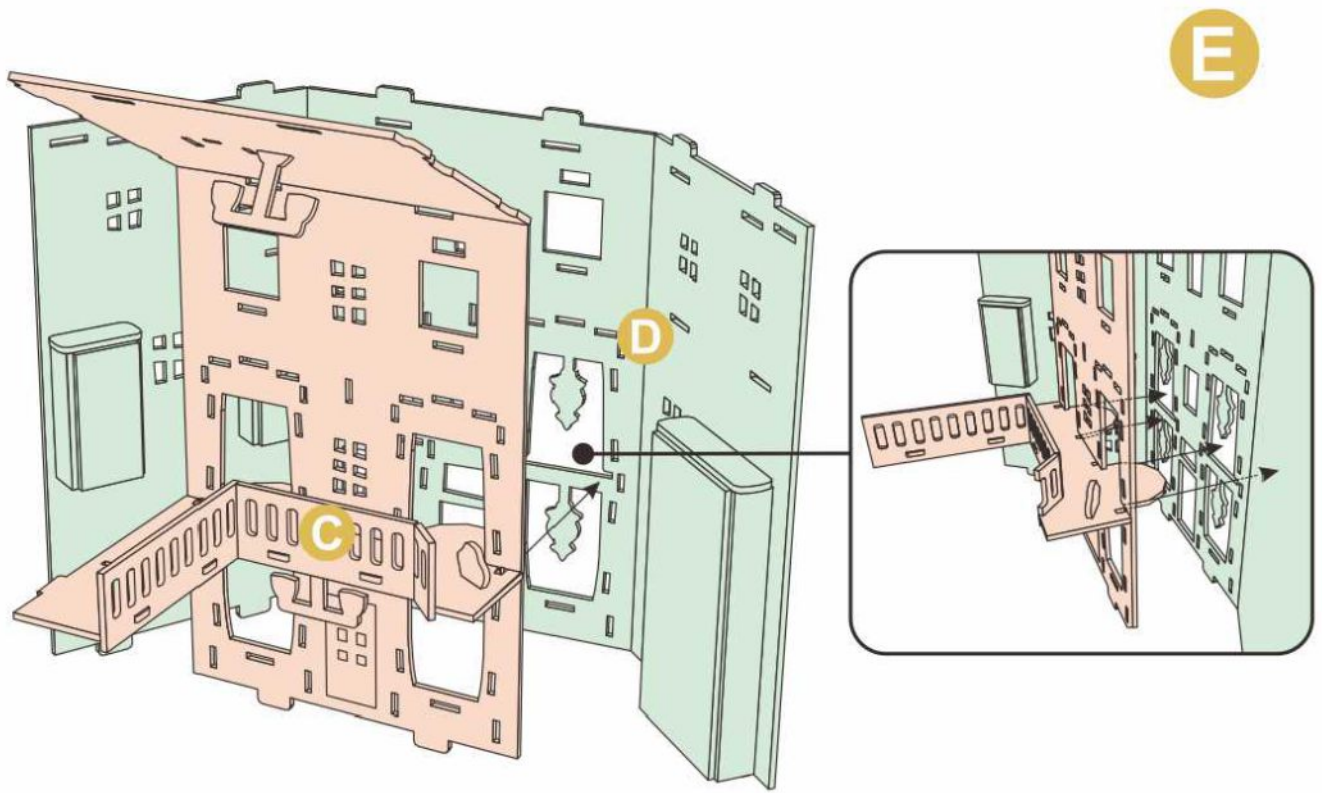

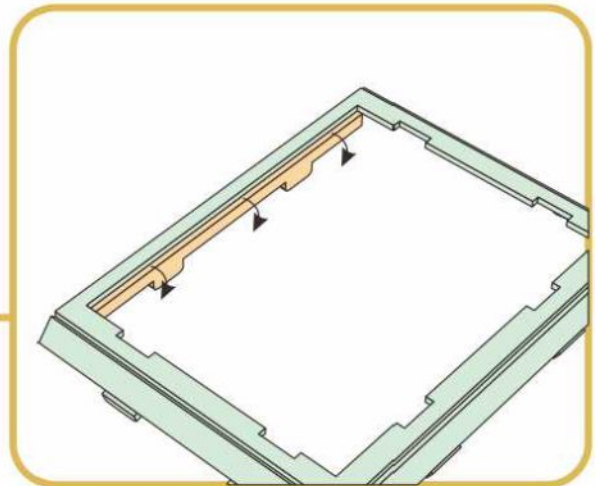
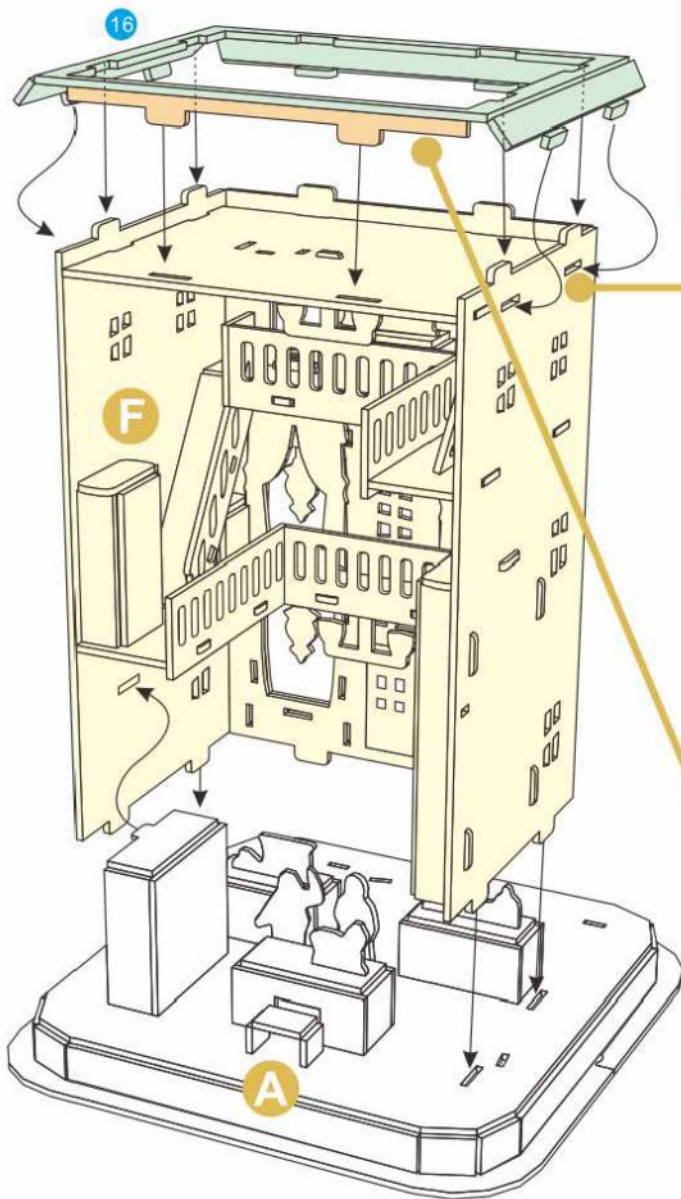
G**Caution**

Please put the small leftover pieces into the garbage after finishing the assembly. Be careful not to let your children eat or put any part of the product, or the packaging into their noses or ears.

Instructions

Refer to the photograph on the package and join the pieces by matching the drawings above. After popping out the pieces, you can punch out the interlocking holes with the corners of the foam boards.

Vorsicht

Bitte werfen Sie nach dem Zusammensetzen die kleinen Reste in den Müll. Achten Sie darauf, dass Ihre Kinder keine Teile des Produktes essen oder in ihre Nase oder Ohren stecken.

Anleitungen

Beziehen Sie sich auf die Fotografie auf der Verpackung und setzen Sie die Teile den oben stehenden Zeichnungen gemäß zusammen. Wenn Sie die Teile gelöst haben, können Sie die ineinandergreifenden Öffnungen mit den Ecken der Schaumstoffplatten ausstanzen.

Attention

Veillez jeter les petites pièces restantes à la poubelle une fois l'assemblage terminé. Veillez à ce que vos enfants n'ingurgitent ni ne mettent aucune pièce du produit ou de l'emballage dans le nez ou les oreilles.

Instructions

Rapportez-vous à la photographie sur l'emballage et assemblez les pièces en suivant les illustrations ci-dessus. Après avoir retiré les pièces, vous pouvez percer les trous d'assemblage avec les angles des feuilles en mousse.

Precaución

Asegúrese de desechar los pequeños elementos sobrantes en el cubo de basura una vez finalizado el montaje. Extreme la vigilancia para impedir que niños pequeños presentes puedan ingerir algún elemento del producto o introduzcan materiales del embalaje en sus fosas nasales u oídos.

Instrucciones

Consulte las ilustraciones presentes en el embalaje a modo de referencia y una de las diferentes piezas para hacerlas coincidir con los dibujos arriba mostrados. Una vez extraídas todas las piezas, podrá perforar los orificios de interconexión en las esquinas de las placas de cartón pluma.

H

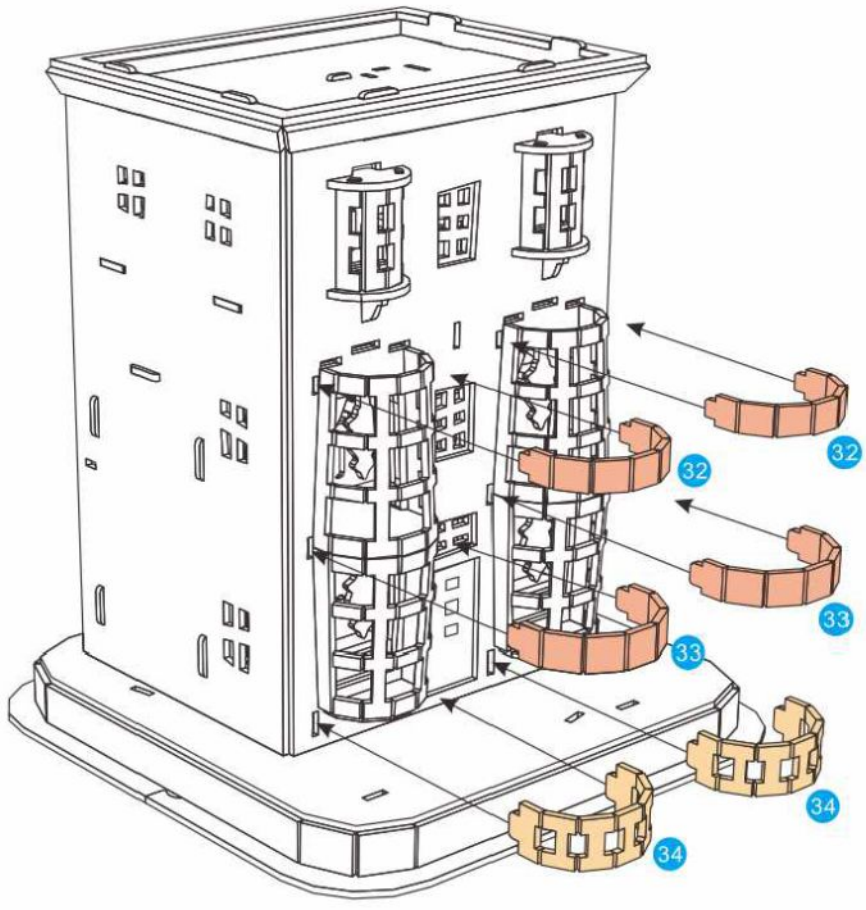
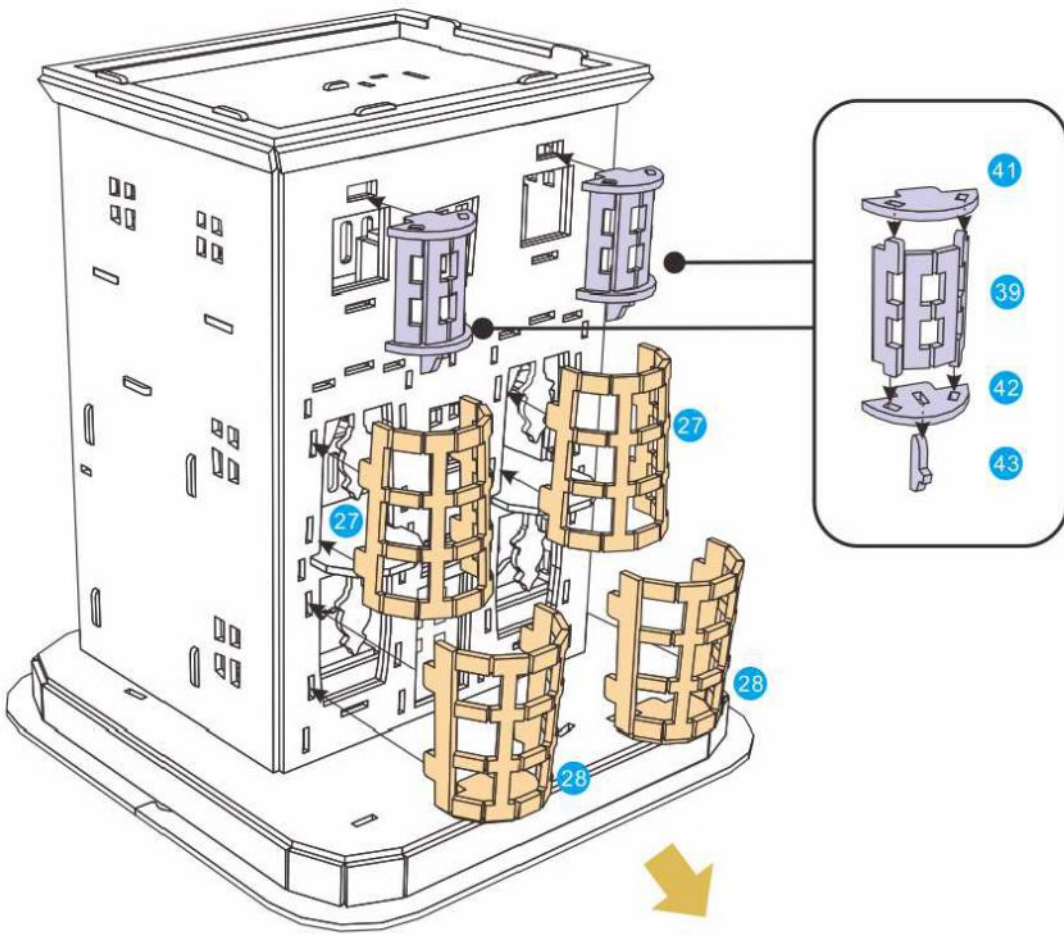

I

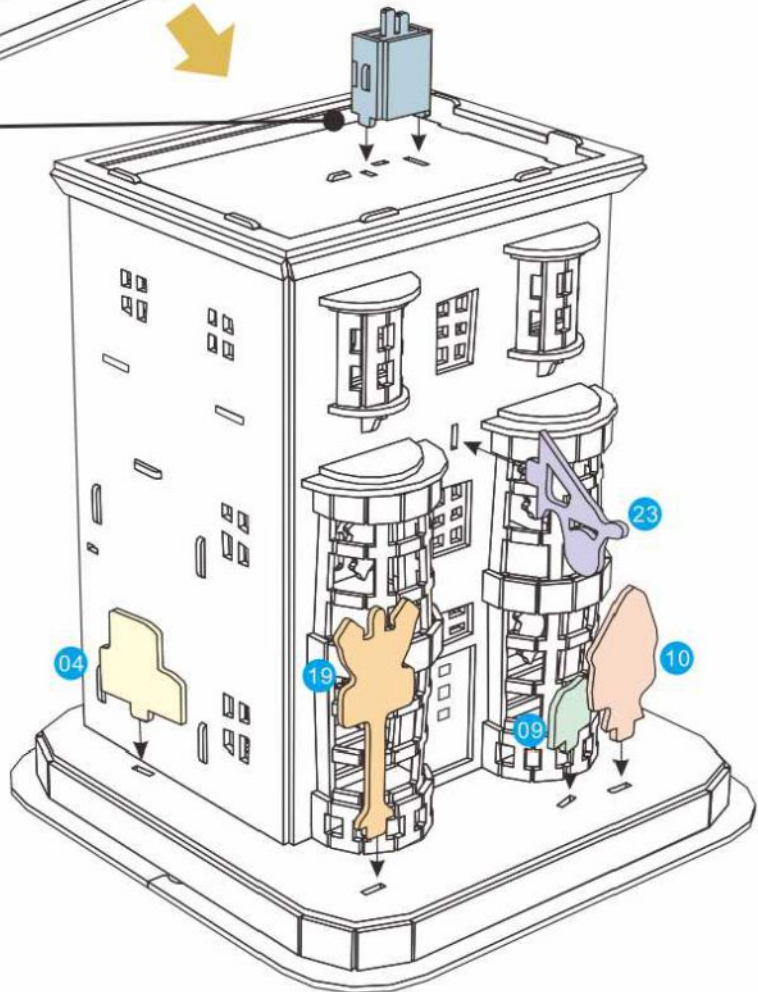
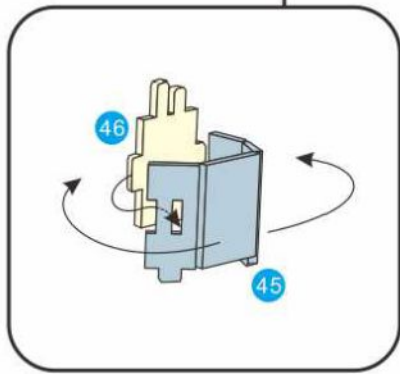
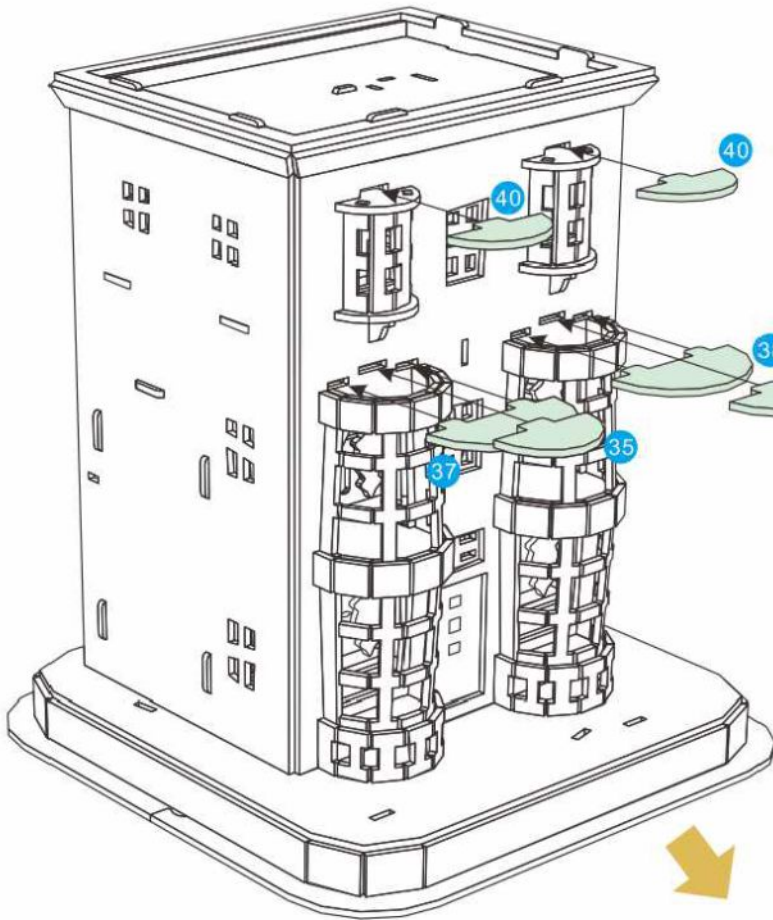

Weasleys' Wizard Wheezes™

A

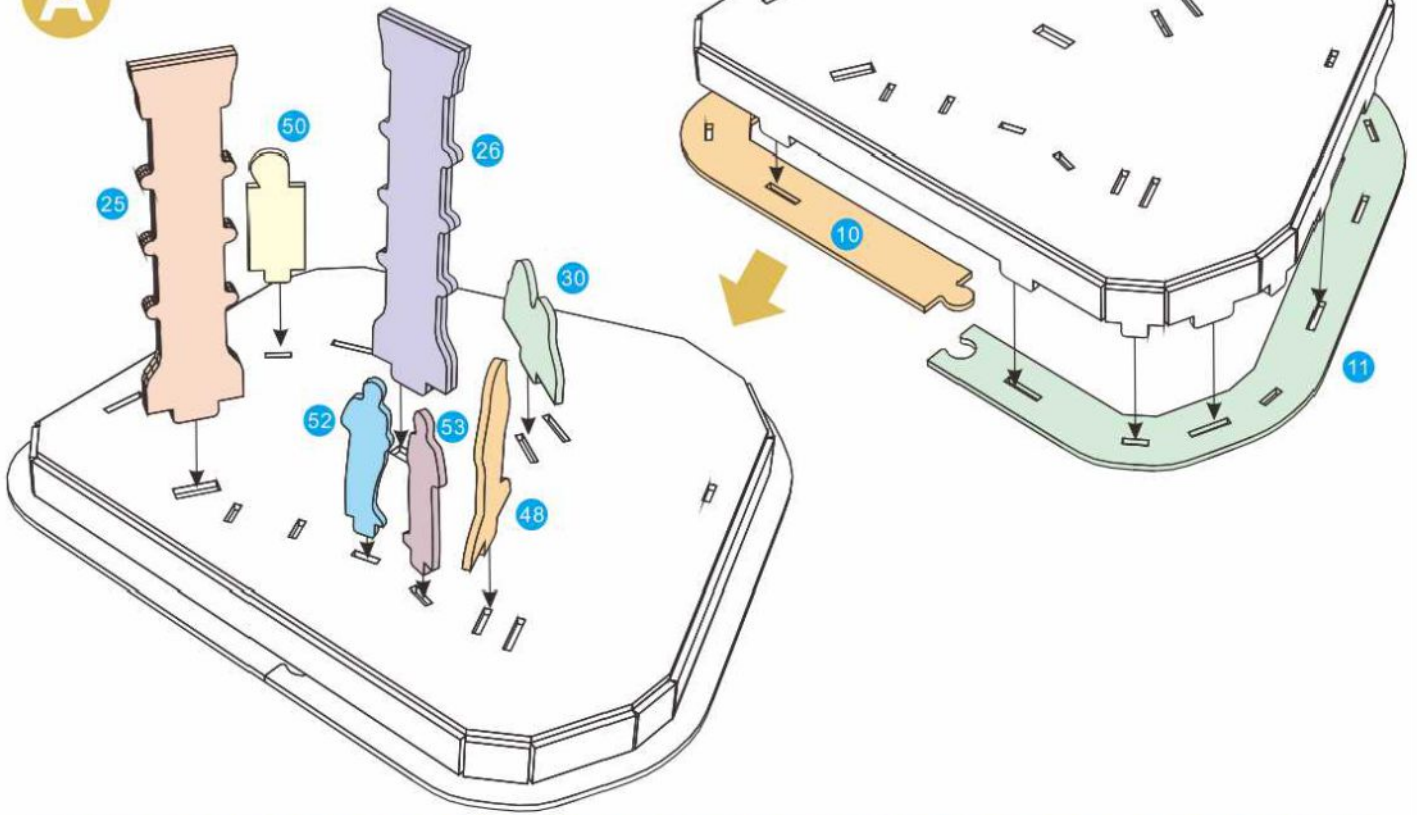

B

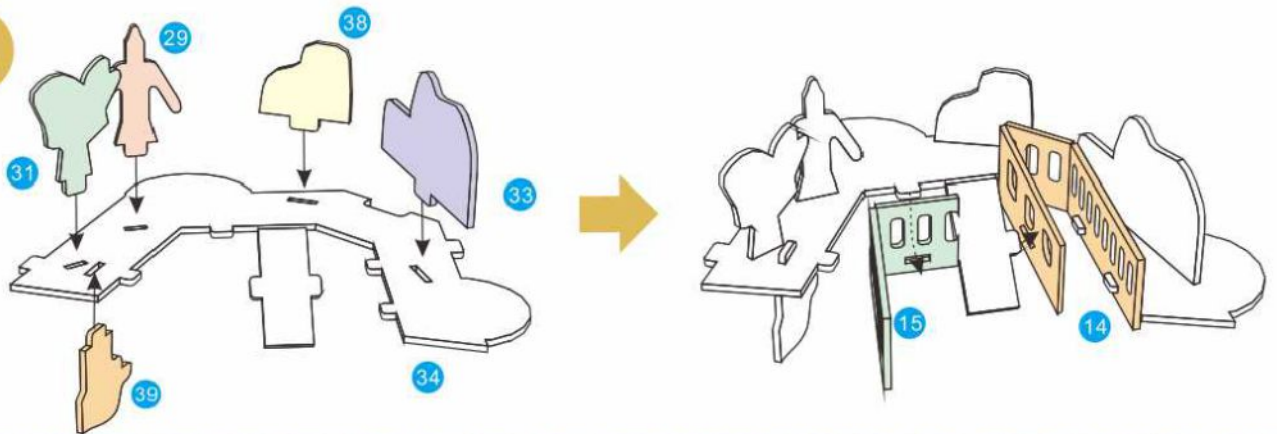

C

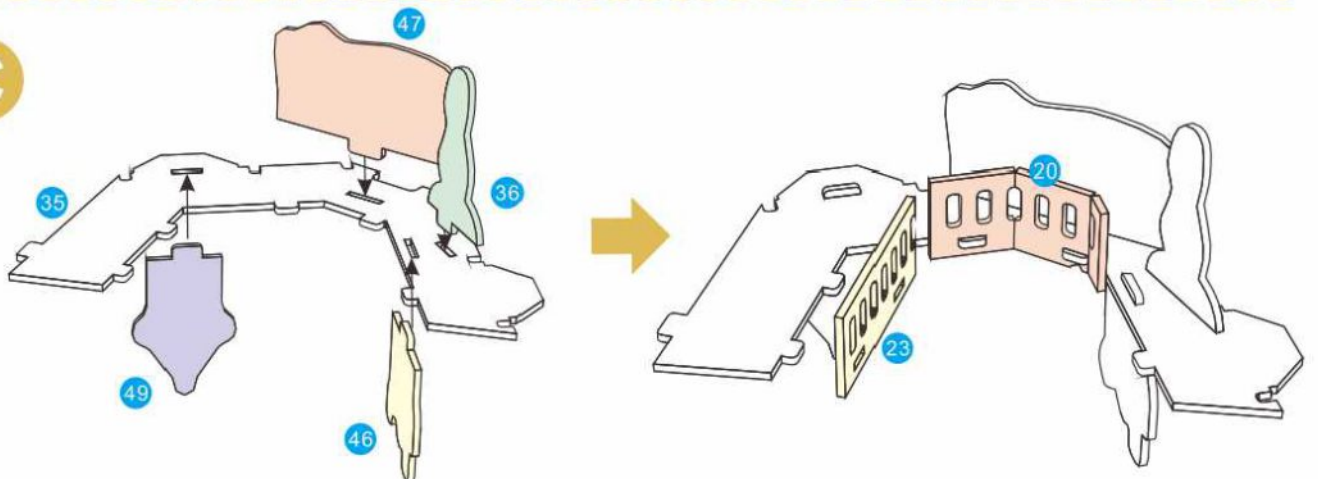

D

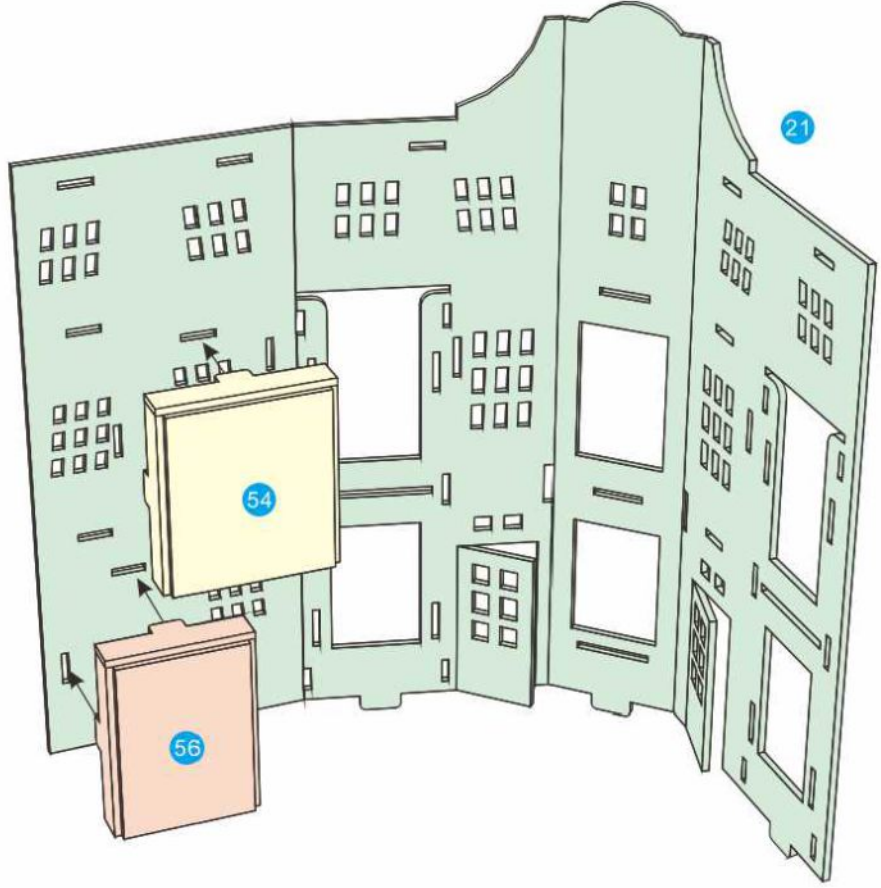

E

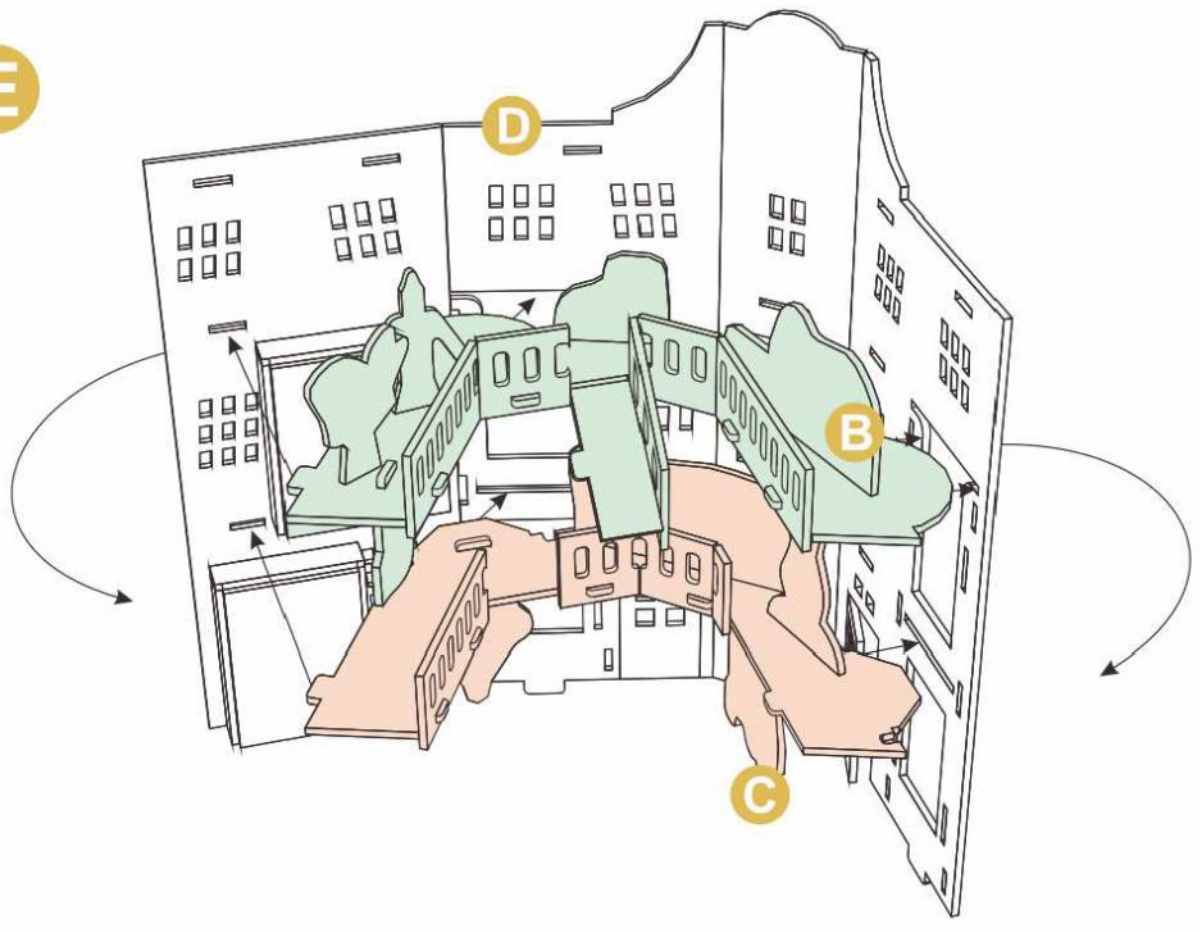

F

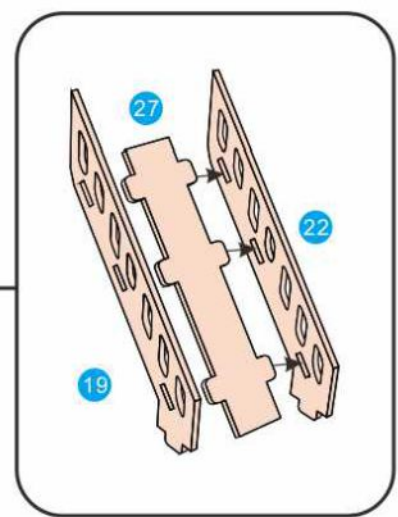
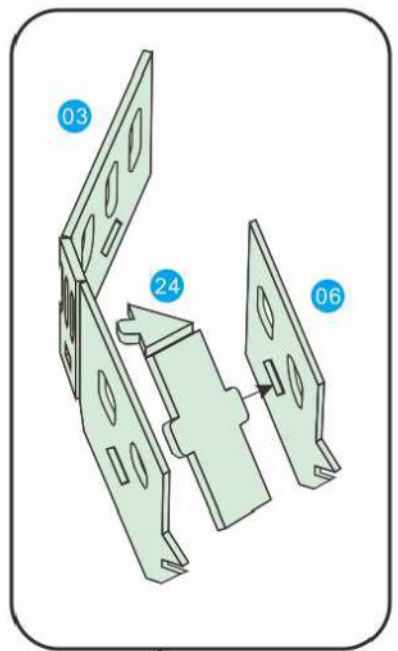
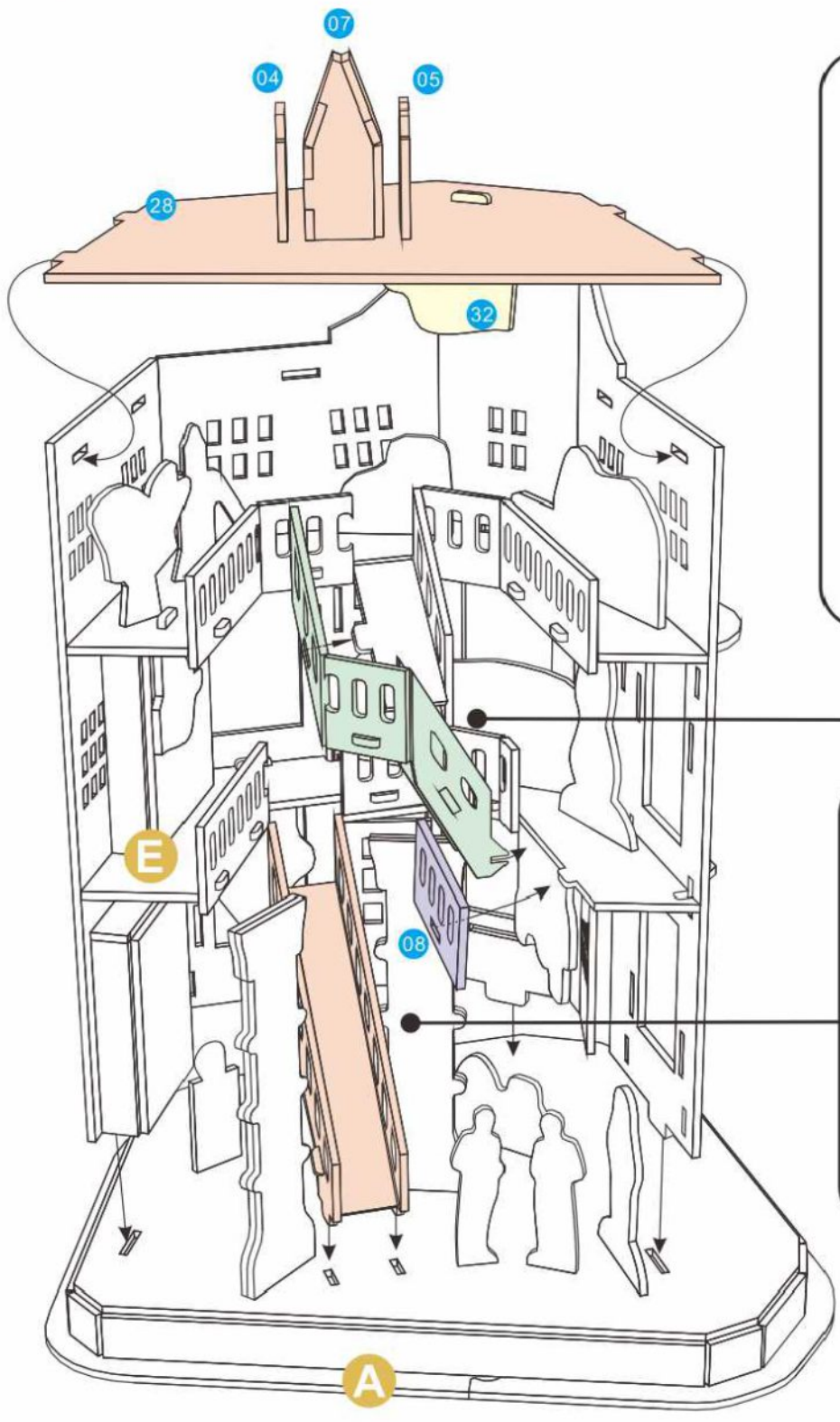

G

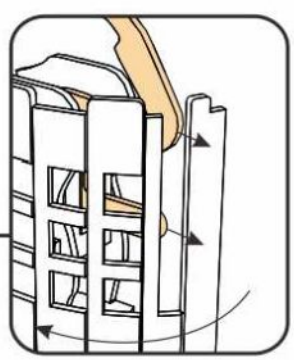
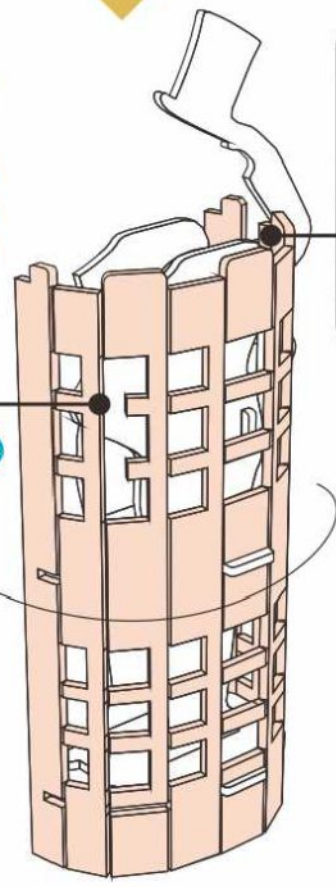
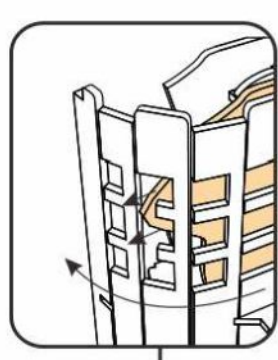
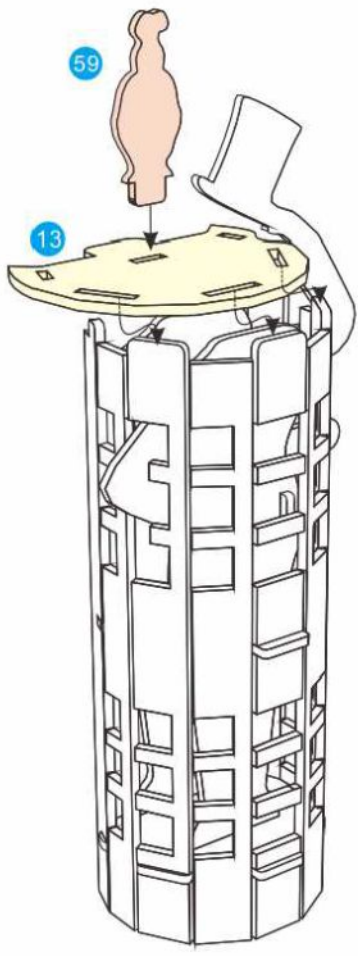
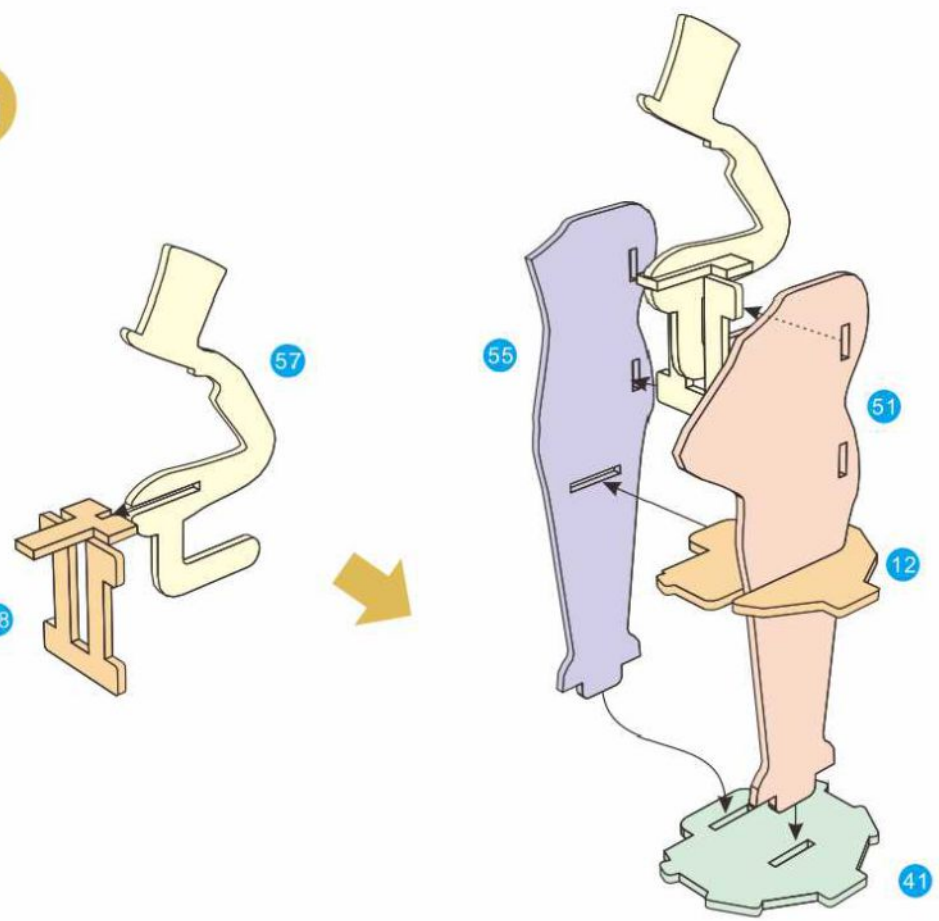

H

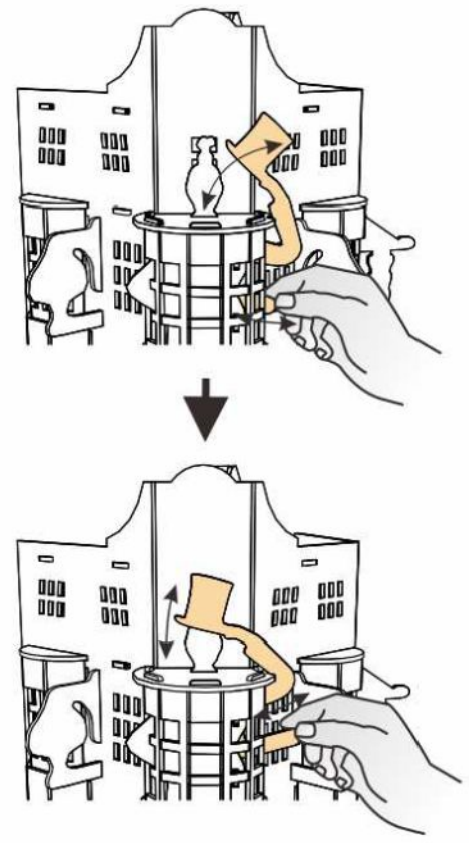
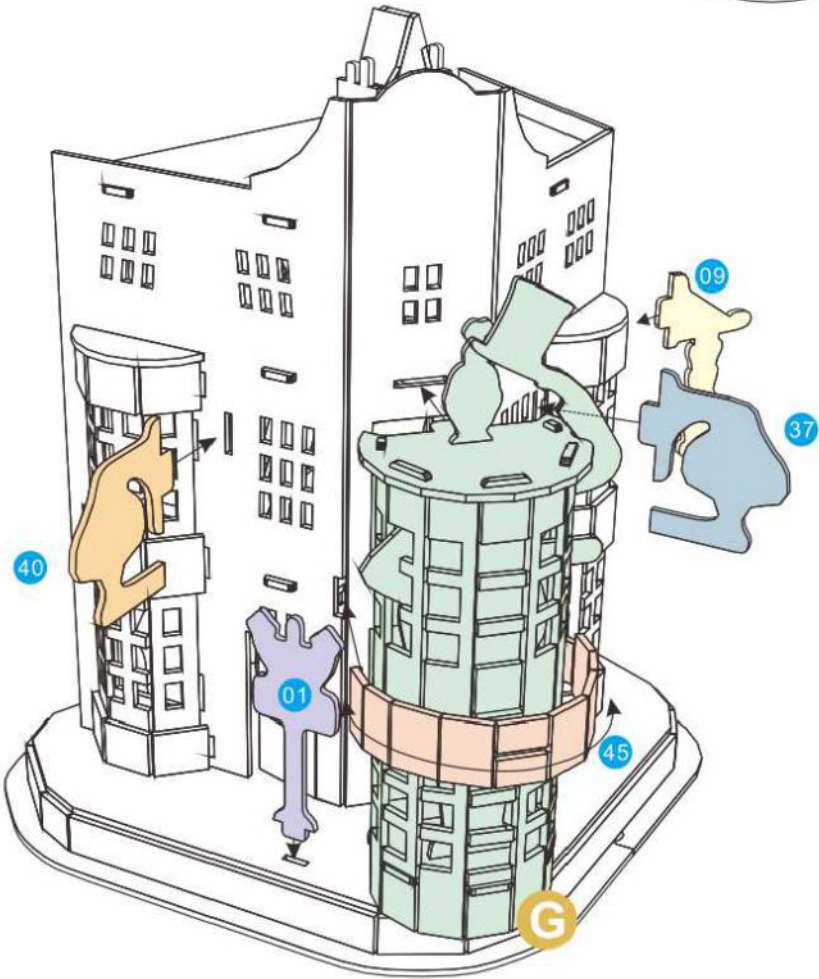
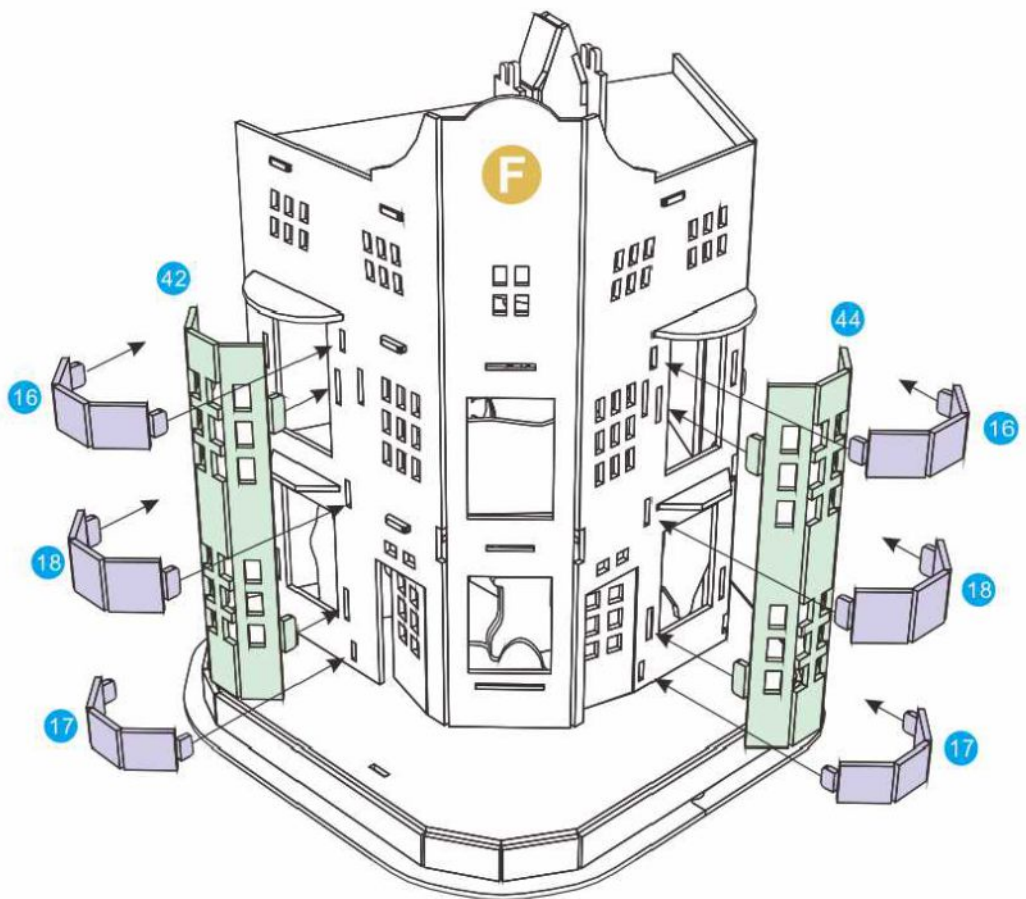

Quality Quidditch Supplies™

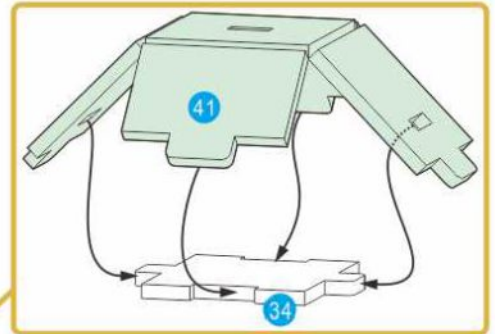
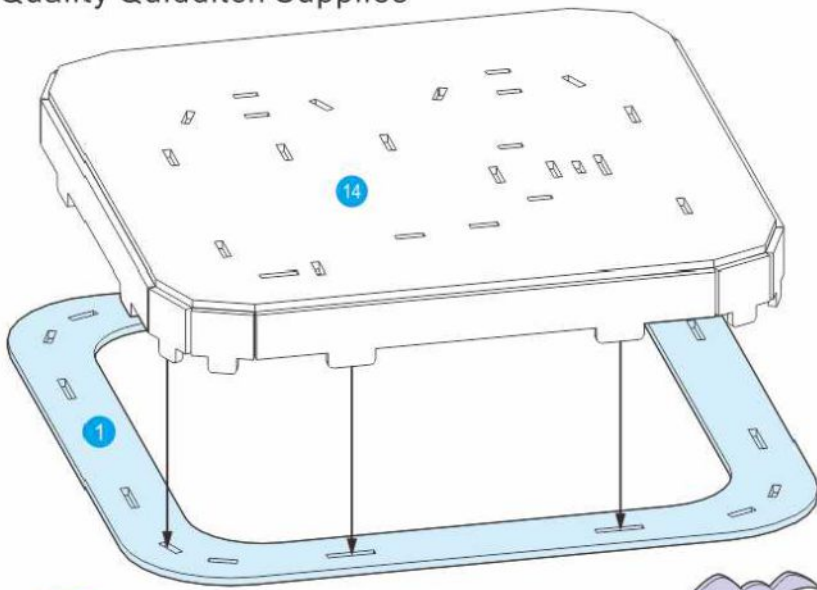

A

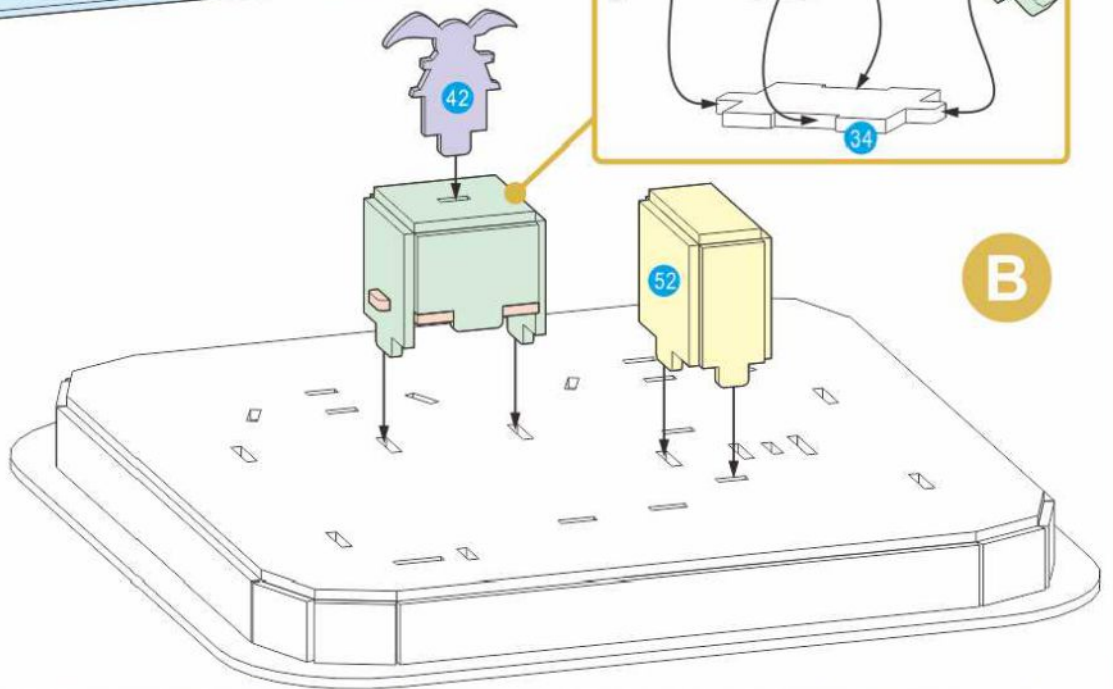

B

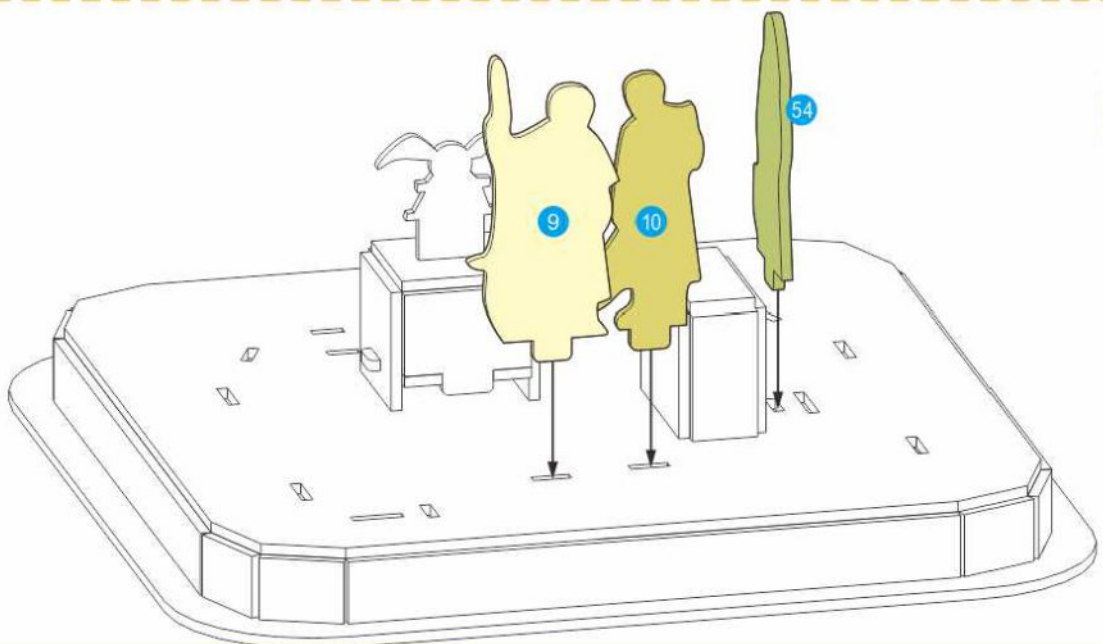

C

D

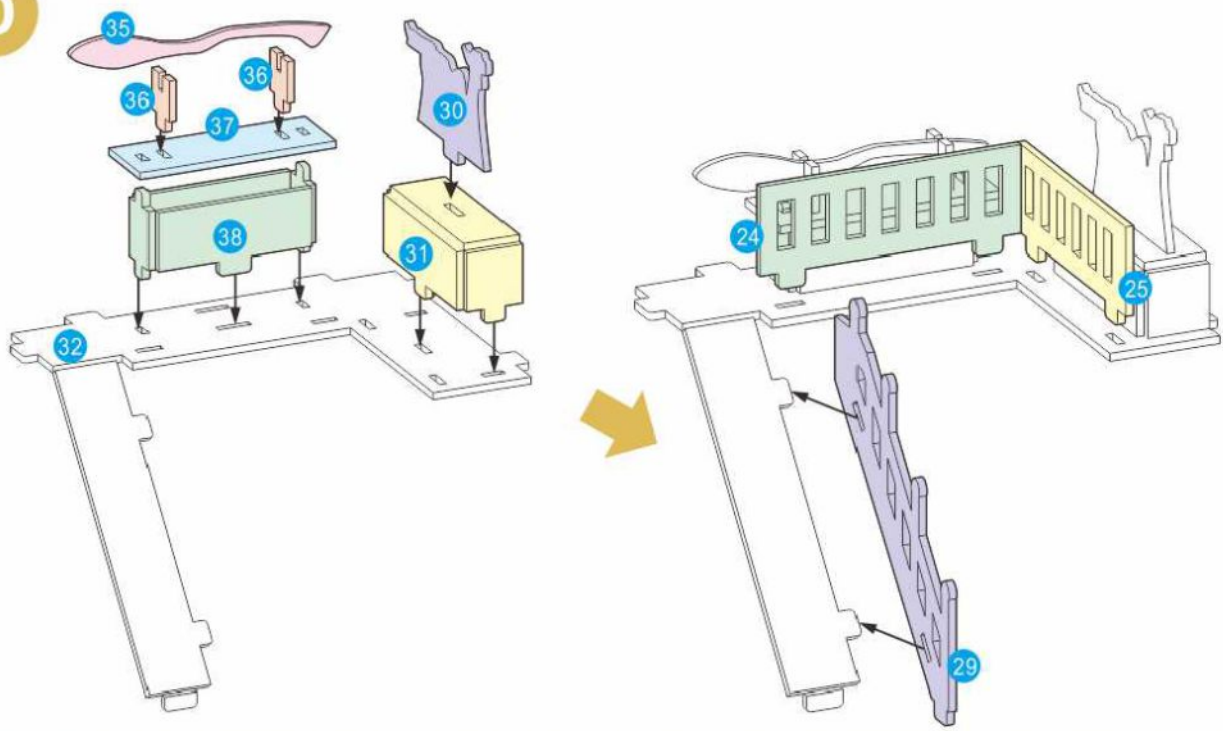

E

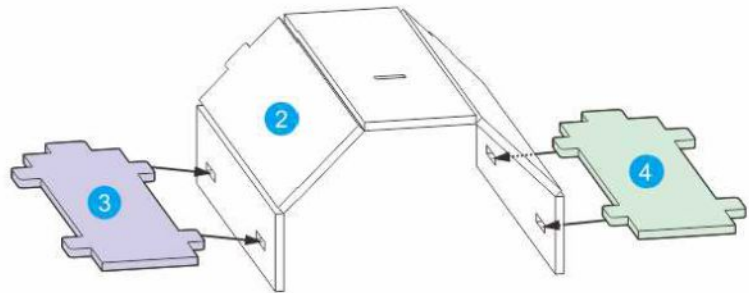

F

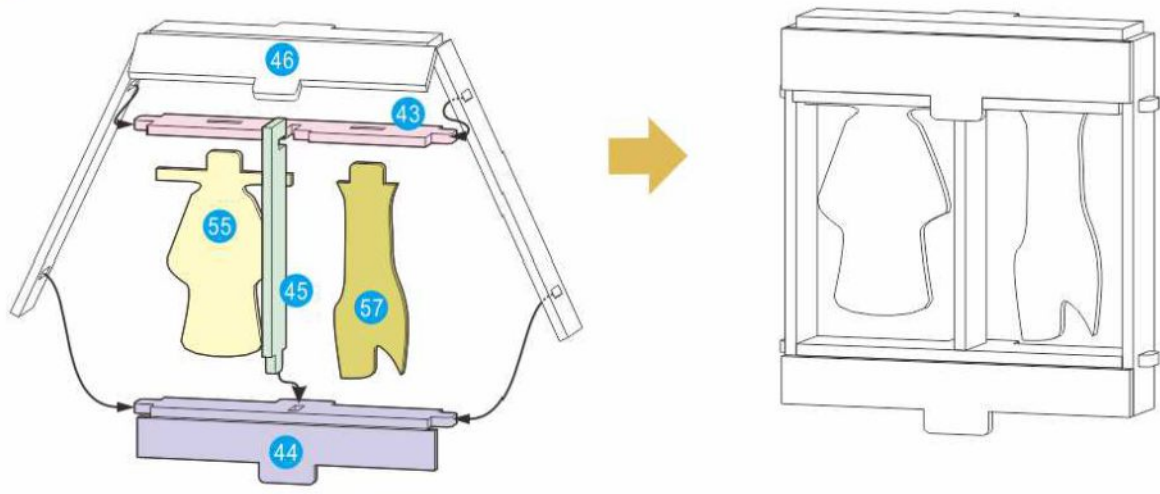

G

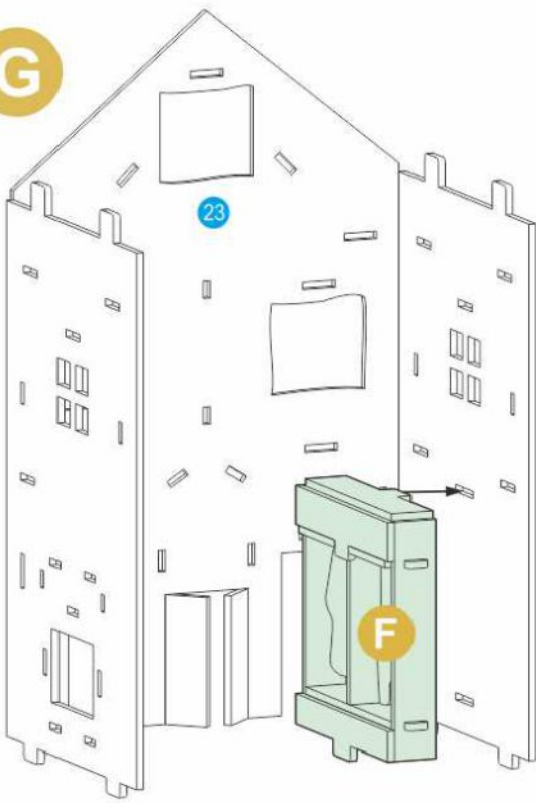

H

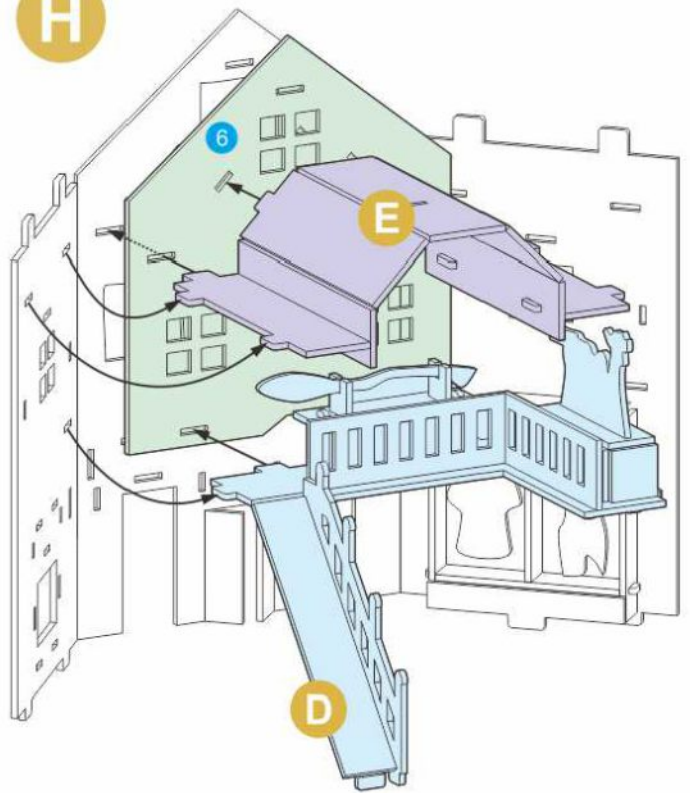

I

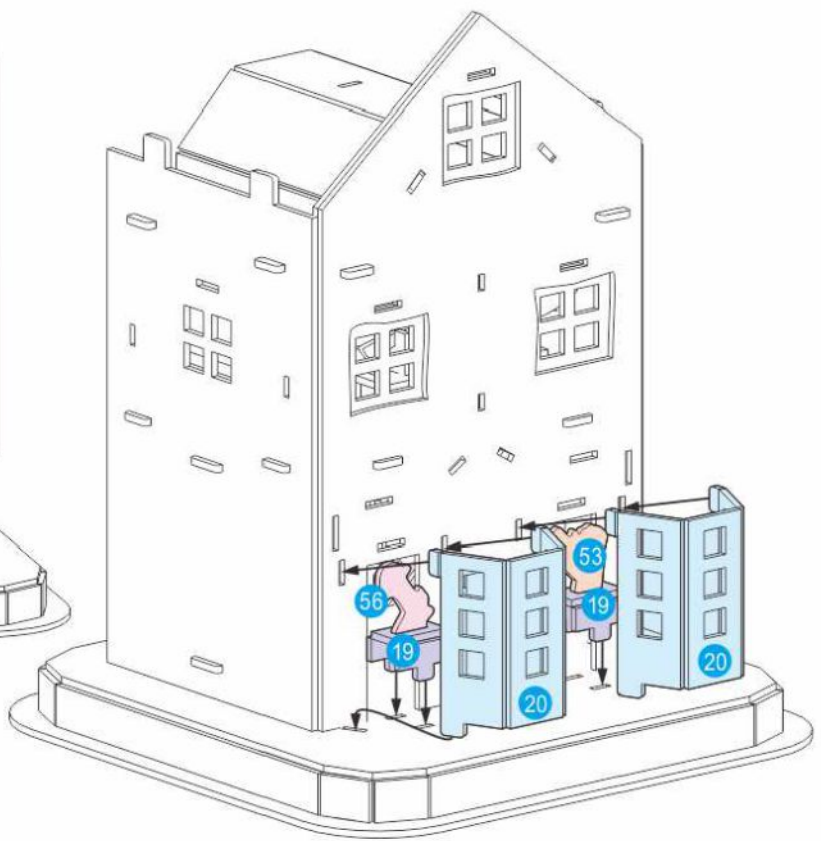
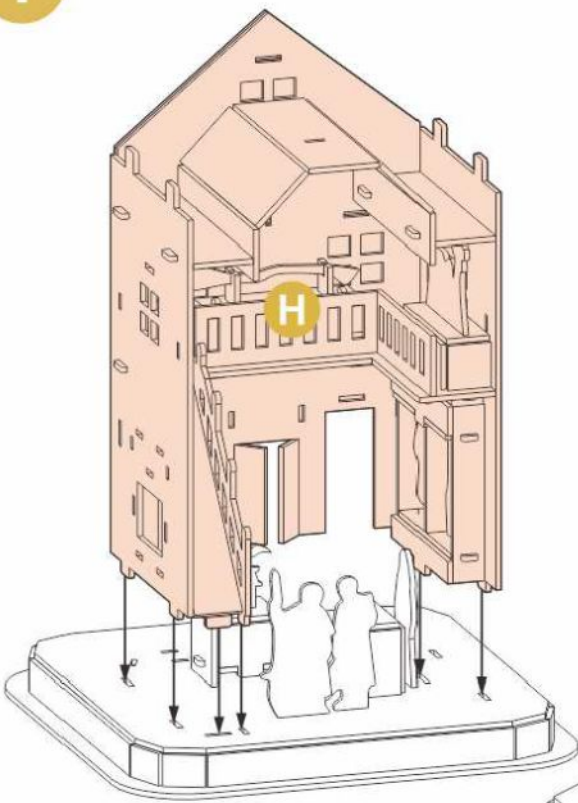

J

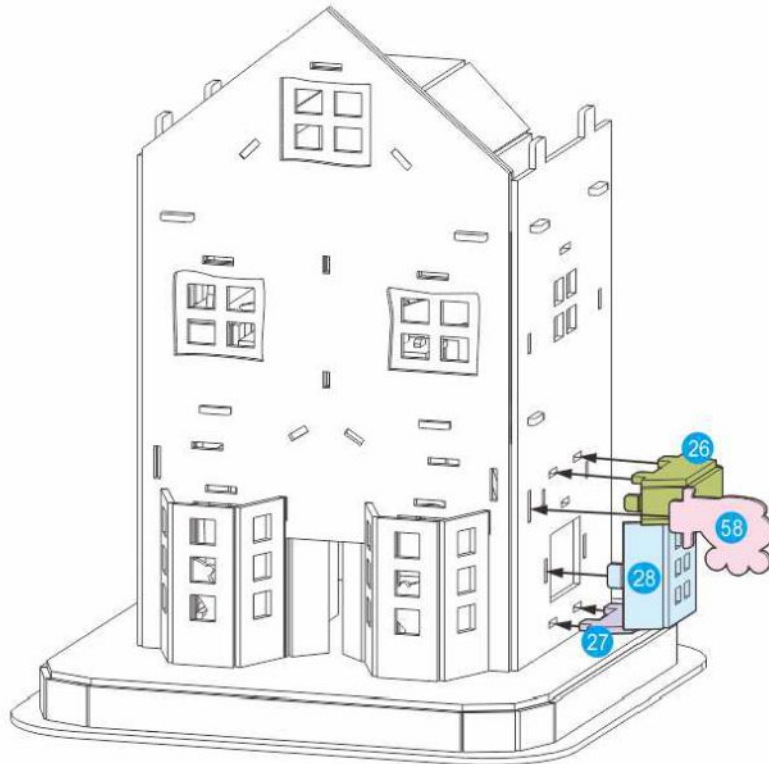

K

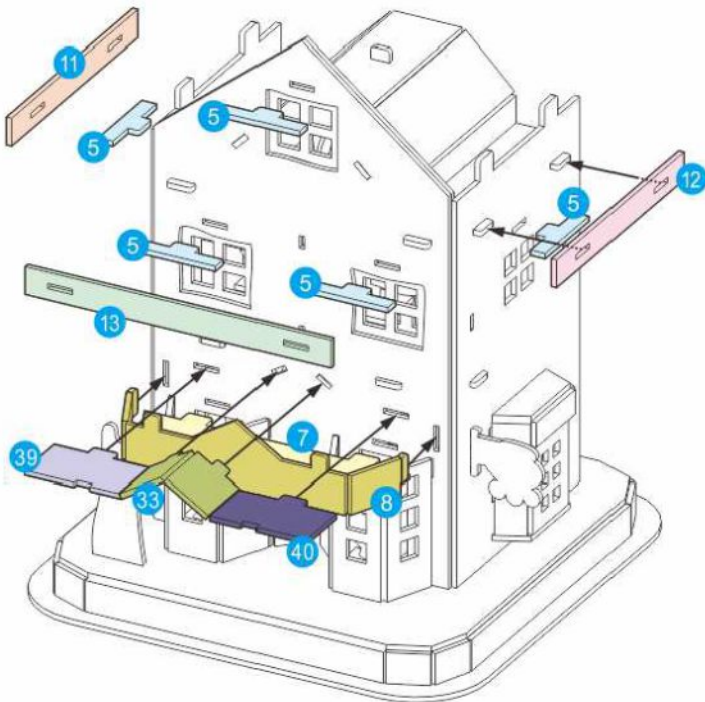

L

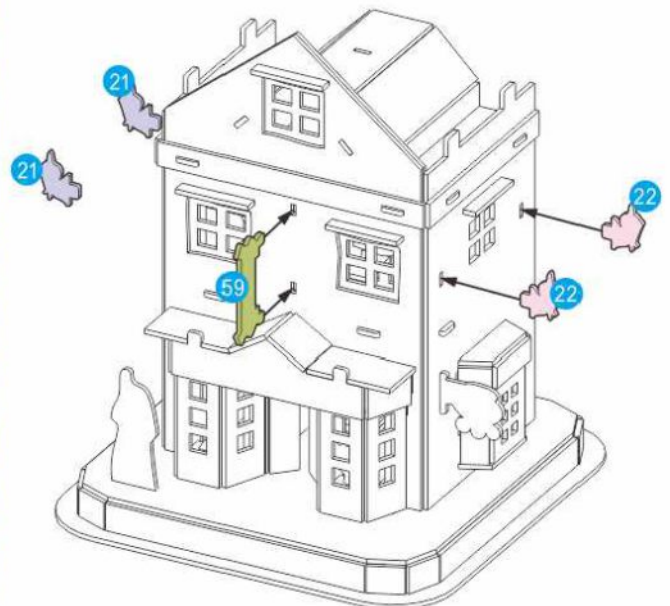

M

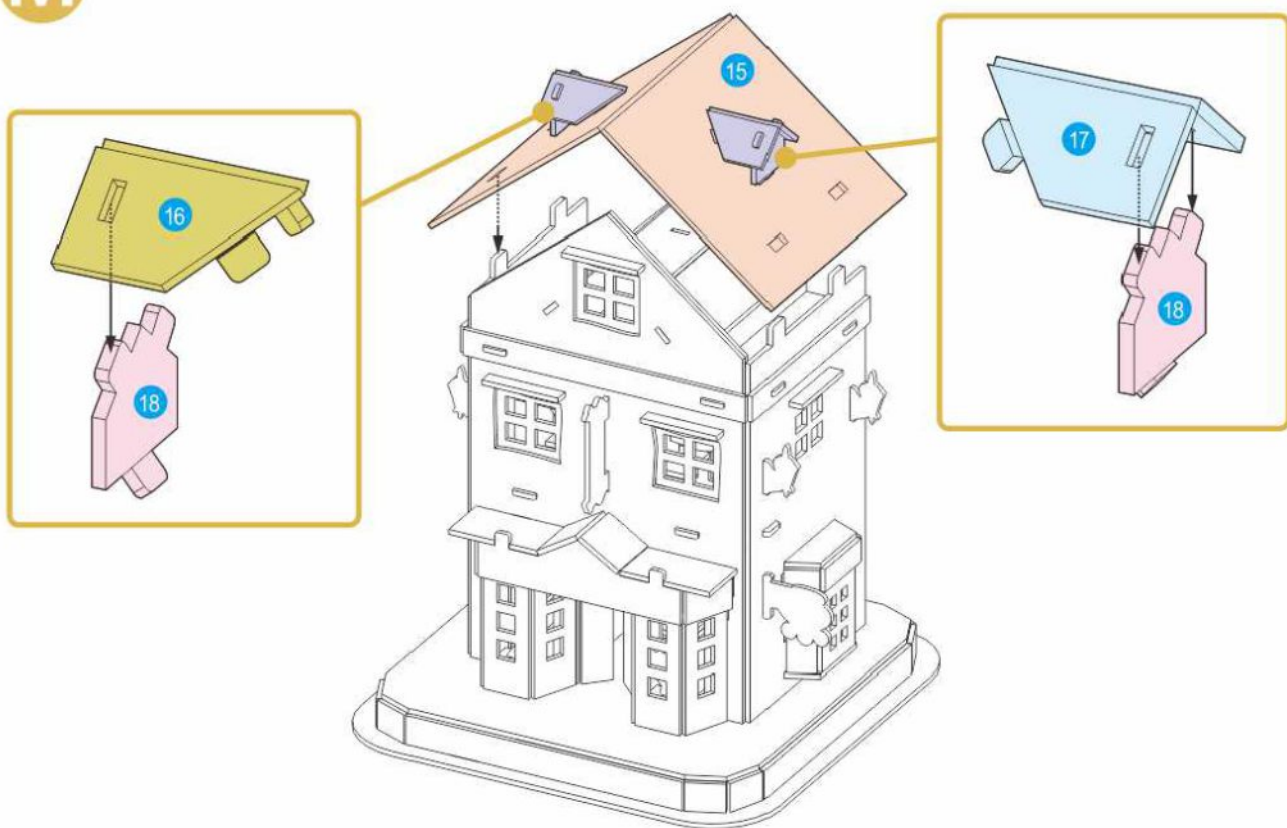

N

