

# XERUN USER MANUAL

Sensored Brushless Motor  
XERUN 3652/3660 G2

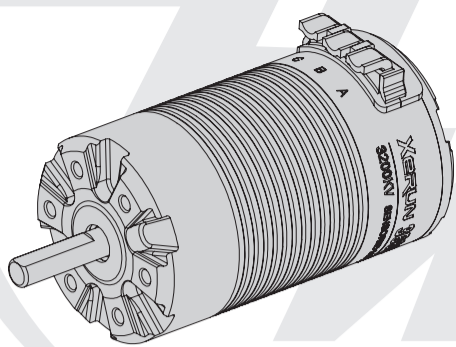

20161215



Thank you for purchasing the XERUN 3652/3660 G2, HOBBYWING's high performance sensored brushless motor! Brushless power systems can be very dangerous, any improper use may cause personal injury and damage to the product and related devices. We strongly recommend reading through this user manual before use. Because we have no control over the use, installation, or maintenance of this product, no liability may be assumed for any damages or losses resulting from the use of this product. We do not assume responsibility for any losses caused by unauthorized modifications to our product.

## 01 Warnings



- Never leave this product unsupervised when it is powered on.
- Ensure all wires and connections are well insulated before connecting the motor to related devices, as short circuit will damage your motor.
- Please strictly follow the A-A, B-B and C-C wiring order when connecting an ESC to the motor.
- Never allow this product to come in contact with water, oil, fuel or other electro-conductive liquids. If this happens, stop the use of your product immediately and let it dry carefully.
- Read through the manuals of all power devices and chassis and ensure the power configuration is rational before using this unit.
- Never hit full throttle before installing the pinion, as high speed rotation may cause damage to the motor in circumstances of no load.
- Ensure all devices are well connected, in order to prevent poor connection that may cause your vehicle to lose control or other unpredictable issues such as damage to the device.
- Stop using the motor when its shell temperature exceeds 100 C/212 F; otherwise the rotor may be demagnetized and cause irreversible damage to your motor.

## 02 Features

- Innovative 4-pole-8-magnet "staggered pole" rotor (Hobbywing-patented) with low cogging effect and torque pulsation greatly improves control feel around corners.
- Built-in chip for making the motor be easily identified by HOBBYWING ESCs. When pairing it with a HW 1/8th sensored ESC (i.e. XR8 SCT/Plus), the motor can work in the "sensored" mode at all times with great output linearity after the identification. The Turbo timing is allowed to be activated for higher output.
- Magnetic ring mounted on the rotor protects the motor from signal interference and guarantees its super stability in the "sensored" mode.
- With the mechanical timing adjustable from 20 degrees to 40 degrees, users are able to have different output power.
- Turbine design implemented by the rotor accelerates the internal air circulation and reduces heat.
- Rebuild-able design (partially rebuild-able) and screw-less motor case for easy routine maintenance effectively prolong the motor life and raise the motor efficiency.
- CNC machined aluminum housing, high purity copper windings, advanced rotor structure, high-quality alloy steel output shaft, high-precision bearings for high durability and smoothness.
- New-style "U" solder tabs at the bottom of the motor for easy soldering and wiring.

## 03 Specifications

PN	Model	KV (No-load)	LiPo	Resistance	No-load Current	Motor Diameter & Length	Shaft Diameter & Length	Poles	Weight	Applications
30401050	XERUN-3652SD-3100KV-D3.175-G2	3100	2-3S	0.0087Ω	2.9A	Φ=36mm (1.417in) L=52.5mm (2.067in)	Φ=3.175mm(0.125in) L=15mm(0.591)	4	192g (6.77oz)	1/10 <sup>th</sup> Light-duty SCT Truck Monster Truck
30401052	XERUN-3652SD-3800KV-D3.175-G2	3800	2-3S	0.0059Ω	3.9A				192g (6.77oz)	
30401053	XERUN-3652SD-4300KV-D3.175-G2	4300	2S	0.0052Ω	4.2A				187g (6.60oz)	
30401054	XERUN-3652SD-5100KV-D3.175-G2	5100	2S	0.0035Ω	4.7A				192g (6.77oz)	
30401055	XERUN-3652SD-6100KV-D3.175-G2	6100	2S	0.0029Ω	5.9A				186g (6.56oz)	
30401056	XERUN-3652SD-3100KV-D5.0-G2	3100	2-3S	0.0087Ω	2.9A				192g (6.77oz)	
30401058	XERUN-3652SD-3800KV-D5.0-G2	3800	2-3S	0.0059Ω	3.9A				192g (6.77oz)	
30401059	XERUN-3652SD-4300KV-D5.0-G2	4300	2S	0.0052Ω	4.2A				187g (6.60oz)	
30401060	XERUN-3652SD-5100KV-D5.0-G2	5100	2S	0.0035Ω	4.7A				192g (6.77oz)	
30401061	XERUN-3652SD-6100KV-D5.0-G2	6100	2S	0.0029Ω	5.9A				186g (6.56oz)	
30401150	XERUN-3660SD-3200KV-D5.0-G2	3200	2-3S	0.0065Ω	3.7A	Φ=36(1.417in) L=62(2.44in)	Φ=5mm(0.197in) L=17mm(0.669in)	218g (7.69oz)	1/10 <sup>th</sup> Heavy-duty SCT Truck Monster Truck	
30401151	XERUN-3660SD-3600KV-D5.0-G2	3600	2-3S	0.0056Ω	4.1A			214g (7.55oz)		
30401152	XERUN-3660SD-4300KV-D5.0-G2	4300	2S	0.0038Ω	4.7A			218g (7.69oz)		

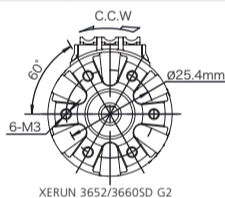

XERUN 3652/3660SD G2

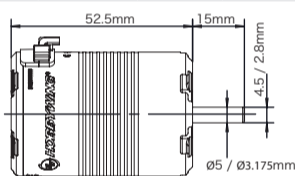

XERUN 3652SD G2

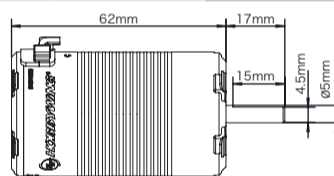

XERUN 3660SD G2

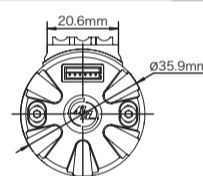

XERUN 3652/3660SD G2

## 04 Installation & Connection

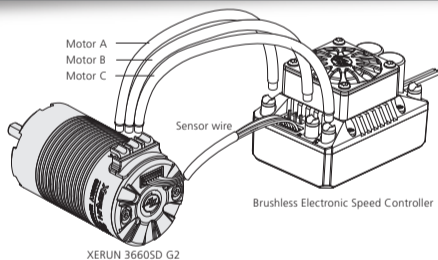

XERUN 3660SD G2

### 1. How to Mount the Motor into a RC vehicle

M3 mounting screws (6\*M3) are needed here, as the mounting holes are 5mm in depth, so we don't recommend using the M3 screws with the length exceeds 8mm to mount the motor into your vehicle.

### 2. How to Connect the Motor to an ESC

There are three power wires coming from the ESC must be soldered to the motor. They are usually color coded as Blue for Wire A, Yellow for Wire B and Orange for Wire C. When connecting the power wires between the ESC and motor, please make sure that you match ESC Wire A to Motor Phase A, ESC Wire B to Motor Phase B and ESC Wire C to Motor Phase C (this is very important).

- When using a Sensored ESC, make sure the sensor cable is clean and undamaged first and then connect the sensor cable to both the ESC and the motor in the correct direction.

- When using a Sensorless ESC, swap any two wires if the motor runs in reverse.

### 3. Recheck the Installation & Connections

Recheck the installation and all the connections before turning on the power.

## 05 Timing Adjustment

- (With the motor direction set to CCW), take the graduation/value after "CCW" on the motor case as the starting point when adjusting the timing. (With the reversed triangle pointing at a value/graduation,) the smaller/bigger the value, the smaller/bigger the timing. The timing is 40 degrees (as shown in picture 1) when the motor direction is set to CCW.
- (With the motor direction set to CW), take the graduation/value after "CW" on the motor case as the starting point when adjusting the timing. (With the reversed triangle pointing at a value/graduation,) the smaller/bigger the value, the smaller/bigger the timing. The timing is 20 degrees (as shown in picture 1) when the motor direction is set to CW.
- The motor timing is 30 degrees by default (as shown in picture 2). The motor timing should be within 30 to 40 degrees if you want to activate the Turbo timing. And the timing can be within 20 to 40 degrees if you have no intention to activate the Turbo timing.

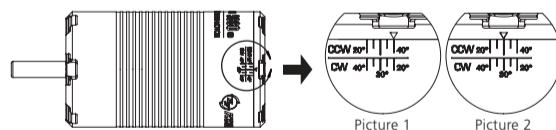

## 06 FDR/Gear Ratio Selection

It's important to select the FDR/gear ratio properly, as improper FDR/gear ratio may cause you great loss. Therefore, please choose the gear ratio by referring to the following points!

### 1. Operating Temperature of the Motor

The motor temperature should be lower than 100°C/212°F during the operation. Temperatures above 100°C will weaken the magnet and may partly melt the coils and eventually damage the ESC (due to strong current). Therefore, the most effective way to prevent overheat is to select the right gear ratio.

### 2. Principle of Gear Ratio Selection

To avoid potential risks such as ESC/motor damage or malfunction caused by overheat, please start with a very small pinion first and check the ESC & motor temperatures regularly throughout the run. This is the only way to guarantee that your motor won't overheat. If the motor and ESC temperatures remain stable and low in the running, then you can slowly increase the pinion size while monitoring temperatures to determine the safe gearing for your vehicle, climate and track condition. Because these elements may change, so please keep monitoring the ESC & motor temperatures to protect your electronics from damage.

## 07 Assembly/Disassembly

For prolonging the motor life and raising its efficiency, we recommend checking and cleaning the motor regularly. About the frequency, it depends on the times you use the motor and the track condition. Please refer to the following diagrams to assemble your motor and dismantle it in the reverse order if necessary.

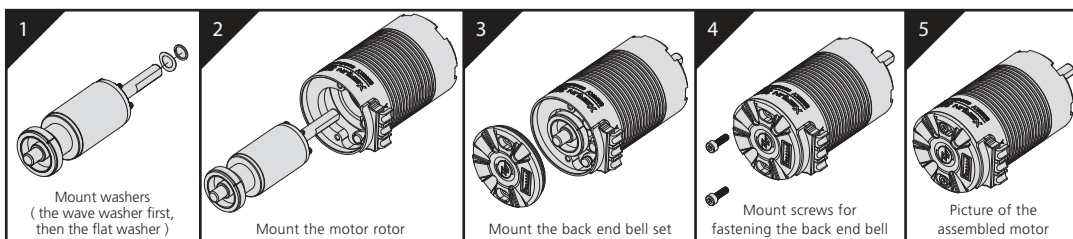

### Parts List:

