

FS-MG4

USER MANUAL

FLYSKY

**Digital Proportional Radio
Control System**

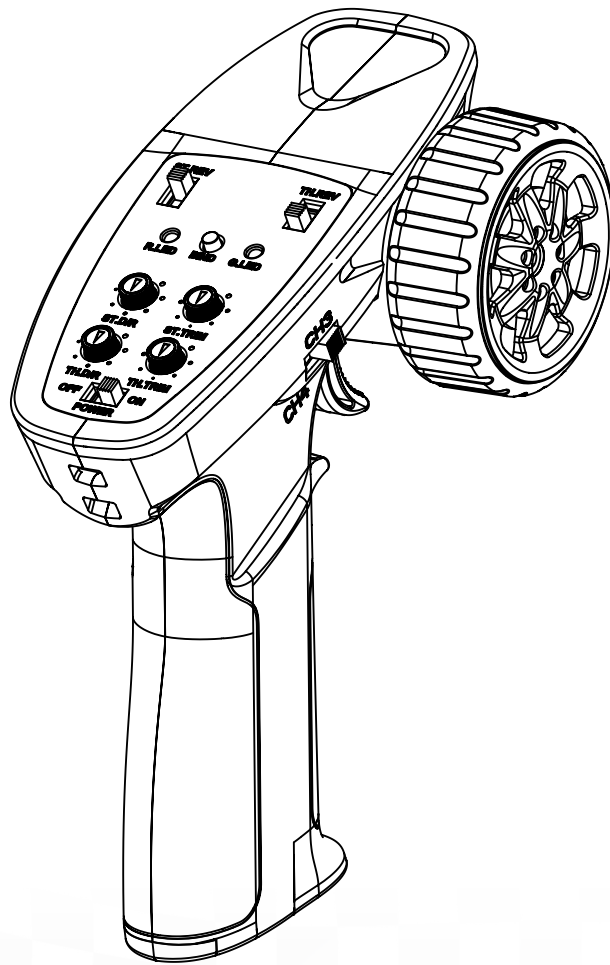

Copyright ©2021 Flysky Technology co., ltd

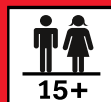

! WARNING:
This product is only for 15 years
old or above



Thank you for purchasing our product, an ideal radio system for beginners or experienced users.

In order to ensure your safety, and the safety of others, read this manual carefully before using this product. If you encounter any problem during use, refer to this manual first. If the problem persists, contact your local dealer or visit our service and support website :

www.flysky-cn.com



Contents

1.Safety	1
1.1 Safety Symbols.....	1
1.2 Safety Guide	1
Mandatory	1
2.Introduction	2
2.1 Transmitter overview.....	2
2.2 Receiver overview (Take FS-R4B as an example)	3
3.Getting Started	4
3.1 Transmitter Battery Installation	4
4.Instructions	5
4.1 Power On	5
4.2 LED	5
4.3 Binding.....	5
4.4 Stick Calibration	6
4.5 Power Off	6
5.System Functions	7
5.1 Channel Description	7
5.2 Channel Reverse	7
5.3 Trims	7
5.4 D/R.....	7
5.5 Mode switching	8
5.6 Failsafe	8
5.7 Beginner Mode	8
6. Product Specifications	9
6.1 Transmitter specification(FS-MG4).....	9
6.2 Receiver Specification	9
7. Package Contents	11
8. Certification	12
8.1 DoC Declaration	12
8.2 CE Warning	12
8.3 Appendix 1 FCC Statement	12
9. Environmentally friendly disposal	13

1. Safety

1.1 Safety Symbols

Pay close attention to the following symbols and their meanings. Failure to follow these warnings could cause damage, injury or death.

 Danger	<ul style="list-style-type: none">• Not following these instructions may lead to serious injuries or death.
 Warning	<ul style="list-style-type: none">• Not following these instructions may lead to major injuries.
 Attention	<ul style="list-style-type: none">• Not following these instructions may lead to minor injuries.

1.2 Safety Guide



Prohibited



Mandatory



- **Do not use the product at night or in bad weather like rain or thunderstorm. It can cause erratic operation or loss of control.**
- **Do not use the product when visibility is limited.**
- **Do not use the product on rain or snow days. Any exposure to moisture (water or snow) may cause erratic operation or loss of control.**
- **Interference may cause loss of control. To ensure the safety of you and others, do not operate in the following places:**
 - Near any site where other radio control activity may occur
 - Near power lines or communication broadcasting antennas
 - Near people or roads
 - On any body of water when passenger boats are present
- **Do not use this product when you are tired, uncomfortable, or under the influence of alcohol or drugs. Doing so may cause serious injury to yourself or others.**
- **The 2.4GHz radio band is limited to line of sight. Always keep your model in sight as a large object can block the RF signal and lead to loss of control.**
- **Do not touch any part of the model that may generate heat during operation, or immediately after use. The engine, motor or speed control, may be very hot and can cause serious burns.**



- **Misuse of this product may lead to serious injury or death. To ensure the safety of you and your equipment, read this manual and follow the instructions.**
- **Make sure the product is properly installed in your model. Failure to do so may result in serious injury.**
- **Make sure to disconnect the receiver battery before turning off the transmitter. Failure to do so may lead to unintended operation and cause an accident.**
- **Ensure that all motors operate in the correct direction. If not, adjust the direction first.**
- **Make sure the model stays within the systems maximum range to prevent loss of control.**

2.Introduction

The FS-MG4 is a simple 4 channel transmitter using the latest AFHDS 2.4GHz ATN frequency hopping technology from Flysky. The transmitter is lightweight and compact in design, comfortable and ergonomic. It has a beginner mode and is easy for beginner players to use.

2.1 Transmitter overview

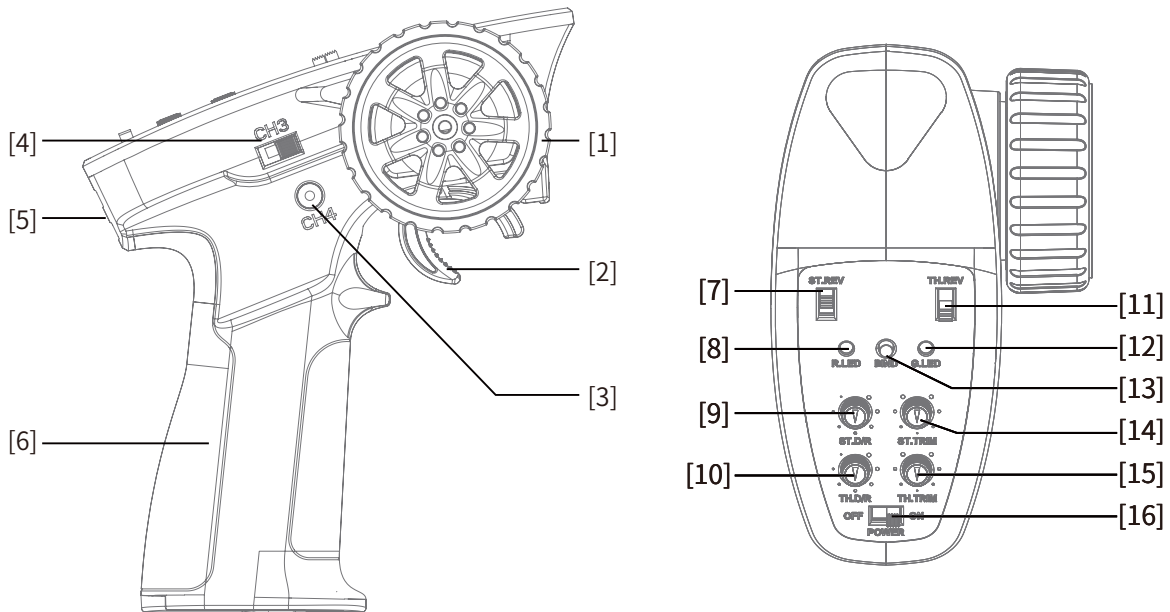

[1]	Traversing handwheel, 35 degrees on each side (CH1)	[9]	ST.D/R
[2]	Throttle button, 25 degrees in front and 12.5 degrees at rear (CH2)	[10]	TH.D/R
[3]	Push button switch (CH4) [Push button function is flip type]	[11]	TH.REV
[4]	Three-position toggle switch (CH3)	[12]	G.LED
[5]	Lanyard hole	[13]	BIND Button
[6]	Handle, 4*AAA battery compartment	[14]	ST.TRIM
[7]	ST.REV	[15]	TH.TRIM
[8]	R.LED	[16]	Power Switch

2.2 Receiver overview (Take FS-R4B as an example)

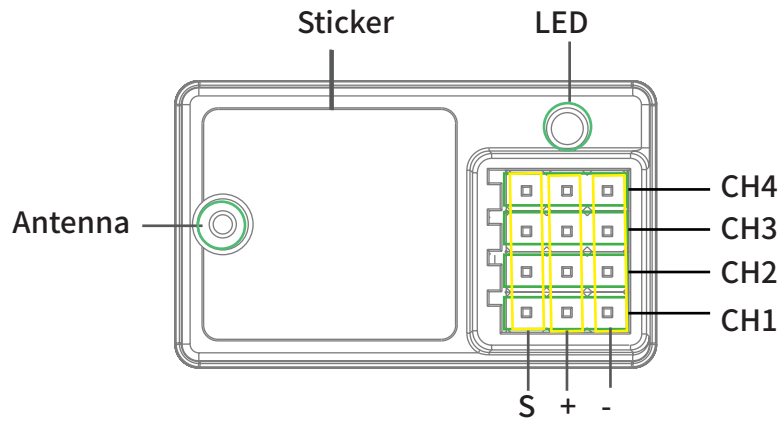







Note

- To ensure the best signal quality make sure that the antenna is mounted perpendicular to the model body in an upright position.

3. Getting Started

Before operation, install the battery and connect the system as instructed below.

3.1 Transmitter Battery Installation

 Danger	• Only use specified battery.
 Danger	• Do not open, disassemble, or attempt to repair the battery.
 Danger	• Do not crush/puncture the battery, or short the external contacts.
 Danger	• Do not expose to excessive heat or liquids.
 Danger	• Do not drop the battery or expose to strong shocks or vibrations.
 Danger	• Always store the battery in a cool, dry place.
 Danger	• Do not use the battery if damaged.

Battery Type:AAA

Battery Installation:

1. Open the battery compartment cover.
2. Insert 4 fully-charged AAA batteries into the compartment. Make sure that the battery makes good contact with the battery compartment's contacts.
3. Replace battery compartment cover.

Low battery alarm: When the battery is lower than 4.2v, the G.LED on the panel will flash slowly.

Note: When installing the batteries, be careful to handle the positive and negative poles. (As shown in the picture on the right)

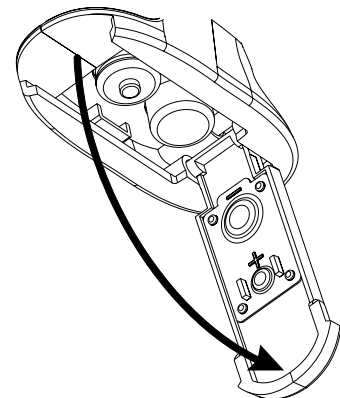

4. Instructions

After setting up, follow the instructions below to operate the system.

4.1 Power On

Follow the steps below to turn on the transmitter:

1. Check to make sure that that battery is fully charged and installed correctly.
2. Toggle the switch to the [ON] position. When active the R.LED will be lit.
3. Connect the receiver to power.

- For safety always power on the transmitter before the receiver.

 Note	• Operate with caution in order to avoid damage or injury.
---	---

 Note	• Make sure that the throttle is at its lowest position and the switches are set to their up position.
---	---

4.2 LED

1. R.LED: Red power indicator;
2. G.LED: Green status indicator;
3. Low battery alarm: When the battery is lower than 4.2v, the G.LED on the panel will flash slowly.

4.3 Binding

The transmitter and receiver have already been bound at the factory.

However if the receiver needs to be replaced or additional receivers bound follow these steps:

1. Turn on the transmitter while holding the bind button to enter bind mode. G.LED will start flashing quickly.
 - Once in bind mode release the bind button.
2. The receiver will enter bind mode atomically when powered on.
3. Once binding is successful the receiver' s LED will flash slowly and the transmitter' s LED will remain solid after being rebooted.

Note: When binding, put the transmitter into bind mode first, then the receiver.

• applicable to the FS-MG4 transmitter and the FR-R4B receiver. Different receivers have different bind procedures. For more information visit the FLYSKY website for manuals and other related information.

• Product information is updated regularly, please visit our website for more information.

4.4 Stick Calibration

This function is used to set the neutral position for throttle and wheel.

Every transmitter is calibrated before leaving the factory, however if recalibration is required, please follow these steps:

1. Turn and hold the wheel as far clockwise as it will turn, hold the throttle all the way forward, then turn on the transmitter in calibration mode.
 - The R.LED and G.LED will flash twice.
2. Calibrate wheel: Turn the wheel completely clockwise, then completely counterclockwise.
 - When calibration is completed the R.LED will be off.
3. Trigger calibration: Pull the trigger back then forward as far as it will go.
 - When calibration is completed the G.LED will be off.
4. Once calibration is complete press the bind key to save and exit.

4.5 Power Off

Follow the steps below to turn off the system:

1. Disconnect the receiver power.
2. Toggle the transmitter's power switch to the off position.



Danger

- **Make sure to disconnect the receiver power before turning off the transmitter. Failure to do so may lead to damage or serious injury.**

5. System Functions

This section focuses on the functions and how to use them.

5.1 Channel Description

The transmitter outputs a total of 4 channels, which are allocated as follows:

- CH1: Steering Wheel
- CH2: Throttle Trigger
- CH3: Three-position Switch
- CH4: Reset Button

Note: By default the output of CH4 is 1000us, after which pressing the button will toggle between 1000 and 2000us.

5.2 Channel Reverse

This function is used to adjust the action direction of the servo or motor.

The ST.REV / TH.REV knobs are the reverse buttons for CH1 and CH2. If the knob is up it indicates reverse, and the down indicates normal.

5.3 Trims

The ST.TRIM is the trims for CH1 (steering), and can be multiplexed as Trims of CH3 ;

The TH.TRIM is the trims for CH2 (throttle), and can be multiplexed as Trims of CH4 ;

For multiplexing switching mode, see [5.5 Mode Switching].

Adjustment range: -120us- + 120us;

ST.TRIM/TH.TRIM: counterclockwise adjustment to increase the trim value. The maximum value is 120 us.

ST.TRIM- / TH.TRIM-: clockwise adjustment to decrease the trim value. The minimum value is -120 us.

5.4 D/R

The ST.D/R is the trims for CH1 (steering), and can be multiplexed as Trims of CH3 ;

The TH.D/R is the trims for CH2 (throttle), and can be multiplexed as Trims of CH4 ;

For multiplexing switching mode, see [5.5 Mode Switching].

Adjustment range: 0-120%;

ST.D/R: counterclockwise adjustment to increase the servo amount. The maximum value is 120%.

ST.D/R: clockwise adjustment to decrease the servo amount. The minimum value is 0%.

TH.D/R: counterclockwise adjustment to increase the servo amount. The maximum value is 120%.

TH.D/R: clockwise adjustment to decrease the servo amount. The minimum value is 0%.

5.5 Mode switching

This function is for reusing the ST.TRIM and ST.D / R buttons for different channels (see [5.3 Trims], [5.4 D/R]).

Function setting:

Under normal power-on condition, press the BIND button twice (within 1S) to switch between mode 1 and mode 2. By default, mode 1 is used.

Mode 1: R.LED is always on. G.LED is off. ST.TRIM is for CH1 trim. ST.D/R is for CH1 servo adjustment. TH.TRIM is for CH2 throttle trim. TH.D/R is for CH2 throttle servo adjustment.

Mode 2: R.LED and G.LED are flashing alternately. ST.TRIM is for CH3 trim. ST.D/R is for CH3 servo adjustment. TH.TRIM is for CH4 trim. TH.D/R is for CH4 servo adjustment.

5.6 Failsafe

This function dictates what the receiver will do in the event that it loses signal from the transmitter, this includes servo position etc.

Setup:

When the transmitter is switched on in normal communication state, keep the channel to be set at the position of the failsafe setup, and press and hold the BIND button for 3S. The G.LED flashes for 2S, indicating that the setting is successful. That is, when the receiver cannot receive the signal, it will output the set failsafe value.

Note: The fail-safe function has no default set at the factory and as such must be set manually. If no failsafe setting has been set, then the receiver will not output anything when signal is lost.

5.7 Beginner Mode

Beginner mode is designed for people new to the hobby.

In this mode the throttle will be limited to 50 percent, The channel range defaults to 1250~1500~1750us.

Setup:

To switch between beginner and normal modes, first press and hold the channel 4 button and Turn the handwheel to the bottom counterclockwise, then turn on the transmitter.

Note: By default, the system is set to normal mode. The GLED will flash slowly for 3 seconds during power on if the system is set to beginner mode.

6. Product Specifications

This section contains FS-MG4 transmitter and FS-R4B /FS-R4D/FS-R4Preceiver specifications.

6.1 Transmitter specification(FS-MG4)

Product Model	FS-MG4
Channels	4
Model Type	Car, Boat
RF	2.4GHz ISM
RF Power	<20dBm
2.4GHz Protocol	ANT
Distance	>150m (ground)
Channel Resolution	1024
Battery	6V DC 1.5AAA*4
Charging Interface	NO
Life time	According to battery type
Low Voltage Warning	<4.2V
Antenna Type	Built-in single antenna
Data Interface	No
Temperature Range	-10°C—+60°C
Humidity Range	20—95%
Online Update	No
Color	Black
size	118*73*145mm
weight	130g
Certification	CE, FCC ID:N4ZMG400

6.2 Receiver Specification

FS-R4B:

Product Model	FS-R4B
PWM Channels	4
RF	2.4GHz ISM
2.4GHz Protocol	ANT
Distance	>150m (ground)
Antenna Type	single antenna
Power	3.5-8.4V
RSSI	No
Data Interface	PWM
Temperature Range	-10°C—+60°C
Humidity Range	20—95%
Online Update	No
weight	5g
size	30.2*18.0*13.0mm
Certification	CE, FCC

FS-R4D:

Product Model	FS-R4D
PWM Channels	4
RF	2.4GHz ISM
2.4GHz Protocol	ANT
Distance	>150m (ground)
Antenna Type	single antenna
Power	3.5-8.4V
RSSI	No
Data Interface	PWM
Temperature Range	-10°C—+60°C
Humidity Range	20—95%
Online Update	No
weight	3.4g
size	34*18.4*11.5mm
Certification	CE, FCC

FS-R4P:

Product Model	FS-R4P
PWM Channels	4
RF	2.4GHz ISM
2.4GHz Protocol	ANT
Distance	>150m (ground)
Antenna Type	Built-in single antenna
Power	3.5-8.4V
RSSI	No
Data Interface	PWM
Temperature Range	-10°C—+60°C
Humidity Range	20—95%
Online Update	No
weight	6g
size	22.6*20.6*25.5mm
Certification	CE, FCC

7. Package Contents

Transmitter*1 (FS-MG4)

Receiver*1 (FS-R4B)

8. Certification

8.1 DoC Declaration

Hereby, [Flysky Technology co., ltd] declares that the Radio Equipment [FS-MG4] is in compliance with RED 2014/53/EU.

The full text of the EU DoC is available at the following internet address: www.flysky-cn.com.

8.2 CE Warning

The antenna(s) used for this transmitter must be installed to provide a separation distance of at least 20 cm from all persons and must not be co-located or operating in conjunction with any other transmitter. End-users and installers must be provided with antenna installation instructions and transmitter operating conditions for satisfying RF exposure compliance.

8.3 Appendix 1 FCC Statement

This equipment has been tested and found to comply with the limits for a Class B digital device pursuant to part 15 of the FCC rules. These limits are designed to provide reasonable protection against harmful interference in a residential installation. This equipment generates, uses and can radiate radio frequency energy and, if not installed and used in accordance with the instructions, may cause harmful interference to radio communications. However, there is no guarantee that interference will not occur in a particular installation. If this equipment does cause harmful interference to radio or television reception, which can be determined by turning the equipment off and on, the user is encouraged to try to correct the interference by one or more of the following measures:

- Reorient or relocate the receiving antenna.
- Increase the separation between the equipment and receiver.
- Connect the equipment into an outlet on a circuit different from that to which the receiver is connected.
- Consult the dealer or an experienced radio/TV technician for help.

To assure continued compliance, any changes or modifications not expressly approved by the party responsible for compliance could void the user's authority to operate this equipment.

This equipment complies with Part 15 of the FCC Rules. Operation is subject to the following two conditions:

- (1) This device may not cause harmful interference, and (2) This device must accept any interference received, including interference that may cause undesired operation.

Caution!

The manufacturer is not responsible for any radio or TV interference caused by unauthorized modifications to this equipment. Such modifications could void the user authority to operate the equipment.

1. The antenna(s) used for this transmitter must be installed to provide a separation distance of at least 20 cm from all persons and must not be co-located or operating in conjunction with any other transmitter. End-users and installers must be provided with antenna installation instructions and transmitter operating conditions for satisfying RF exposure compliance.
2. Move all your channels to the desired position.
3. Select [All channels] and then [Yes] in the confirmation box.

9. Environmentally friendly disposal

Old electrical appliances must not be disposed of together with the residual waste, but have to be disposed of separately. The disposal at the communal collecting point via private persons is for free. The owner of old appliances is responsible to bring the appliances to these collecting points or to similar collection points. With this little personal effort, you contribute to recycle valuable raw materials and the treatment of toxic substances.



CAUTION

RISK OF EXPLOSION IF BATTERY IS REPLACED BY AN INCORRECT TYPE.
DISPOSE OF USED BATTERIES ACCORDING TO THE INSTRUCTIONS

FLYSKY

www.flysky-cn.com

Copyright ©2021 Flysky Technology co., ltd

Release date: 2021-04-22



CE, FCC ID: N4ZMG400