

# FS-MG7

## USER MANUAL

### Automatic Frequency Hopping Digital System

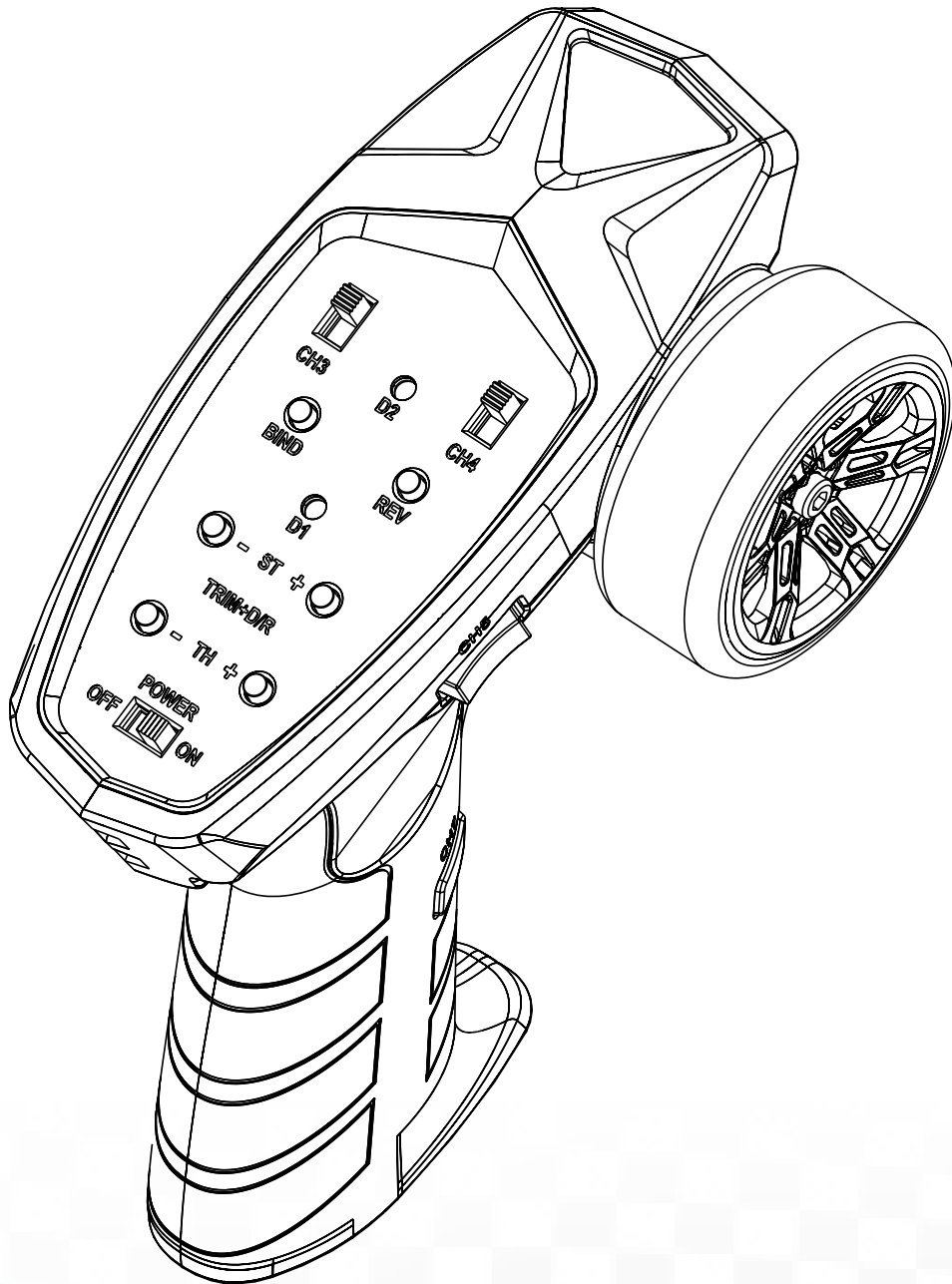

微信公众号



Bilibili



Website



Facebook



15+



**WARNING:**

This product is only for 15 years old or above



Thank you for purchasing our products.

Read the manual carefully to ensure your personal safety as well as the safety of your equipment.

If you encounter any problems during using, please refer to this manual first. If the problem is still not resolved, please contact the local dealer directly or contact the customer service staff via the website below:

<http://www.flysky-cn.com>

# Contents



<b>1.Safety .....</b>	<b>1</b>
1.1 Safety Symbols .....	1
1.2 Safety Guide .....	1
<b>2.Introduction.....</b>	<b>2</b>
2.1 Transmitter Overview .....	2
2.2 Receiver Overview .....	3
2.2.1 The LED Status of the Receiver .....	3
2.2.2 Interface .....	3
2.2.3 Antenna .....	3
<b>3.Getting Started.....</b>	<b>4</b>
3.1 Transmitter Antenna.....	4
3.2 Receiver and Servo Installation .....	4
3.3 Installing Transmitter Battery .....	5
<b>4. Operation Guide .....</b>	<b>6</b>
4.1 Power-on .....	6
4.2 The LED Status of the Transmitter.....	6
4.3 Binding .....	7
4.4 One-way And Two-way Switching.....	7
4.5 Stick Calibration.....	8
4.6 Ambient Light.....	8
4.7 Power Off .....	8
<b>5.System Functions .....</b>	<b>9</b>
5.1 Channel Description .....	9
5.2 Channel Switching.....	9
5.3 Channel Reverse .....	10
5.4 Trim Setting.....	10
5.5 D/R Setting .....	10
5.6 Switching Model .....	11
5.7 2-in-1 Mode .....	11
5.8 Beginner Mode.....	11
5.9 Failsafe.....	12
5.10 Reset Data .....	12
5.11 Idle Alarm .....	12
5.12 Sleep Mode.....	13
5.13 Offline Prompt.....	13
5.14 Transmitter Voltage Alarm .....	13
5.15 Receiver Voltage Alarm.....	13

5.16 Factory Reset.....	13
<b>6. FS-R7D Function Instructions .....</b>	<b>14</b>
6.1 Attentions .....	14
6.2 Binding Instruction .....	14
6.3 Car Light Control.....	14
6.4 Firmware Update .....	15
6.5 Failsafe.....	15
<b>7. Customized Definition .....</b>	<b>16</b>
7.1 Steering Wheel Angle Adjustment Instruction.....	16
<b>8. Specifications.....</b>	<b>18</b>
8.1 Transmitter Specifications .....	18
8.2 Receiver Specifications .....	19
<b>9. Package Contents .....</b>	<b>20</b>
<b>10. Certifications.....</b>	<b>21</b>
10.1 DoC Declaration .....	21
10.2 CE Warning .....	21
10.3 FCC Statement .....	21
10.4 Environmentally friendly disposal .....	22

# 1. Safety

## 1.1 Safety Symbols

Pay close attention to the following symbols and their meanings. Failure to follow these warnings could cause damage, injury or death.

 <b>Danger</b>	<ul style="list-style-type: none"><li>• <b>Not following these instructions may lead to serious injuries or death.</b></li></ul>
 <b>Warning</b>	<ul style="list-style-type: none"><li>• <b>Not following these instructions may lead to major injuries.</b></li></ul>
 <b>Attention</b>	<ul style="list-style-type: none"><li>• <b>Not following these instructions may lead to minor injuries.</b></li></ul>

## 1.2 Safety Guide



**Prohibited**



**Mandatory**



- **Do not use the product at night or in bad weather like rain or thunderstorm. It can cause erratic operation or loss of control.**
- **Do not use the product when visibility is limited.**
- **Do not use the product on rain or snow days. Any exposure to moisture (water or snow) may cause erratic operation or loss of control.**
- **Interference may cause loss of control. To ensure the safety of you and others, do not operate in the following places:**
  - Near any site where other radio control activity may occur
  - Near power lines or communication broadcasting antennas
  - Near people or roads
  - On any body of water when passenger boats are present
- **Do not use this product when you are tired, uncomfortable, or under the influence of alcohol or drugs. Doing so may cause serious injury to yourself or others.**
- **The 2.4GHz radio band is limited to line of sight. Always keep your model in sight as a large object can block the RF signal and lead to loss of control.**



- **Misuse of this product may lead to serious injury or death. To ensure the safety of you and your equipment, read this manual and follow the instructions.**
- **Make sure the product is properly installed in your model. Failure to do so may result in serious injury.**
- **Make sure to disconnect the receiver battery before turning off the transmitter. Failure to do so may lead to unintended operation and cause an accident.**
- **Ensure that all motors operate in the correct direction. If not, adjust the direction first.**
- **Make sure the model stays within the systems maximum range to prevent loss of control.**



微信公众号



Bilibili



Website



Facebook

## 2.Introduction

The FS-MG7 is a 7-channel transmitter which is compatible with the 2.4GHz ANT Automatic Frequency Hopping Digital System, featuring compact design, comfortable to the hand, ergonomic. In addition, the ESC parameters can be set at the transmitter side. The transmitter also has a beginner mode for beginners.

### 2.1 Transmitter Overview

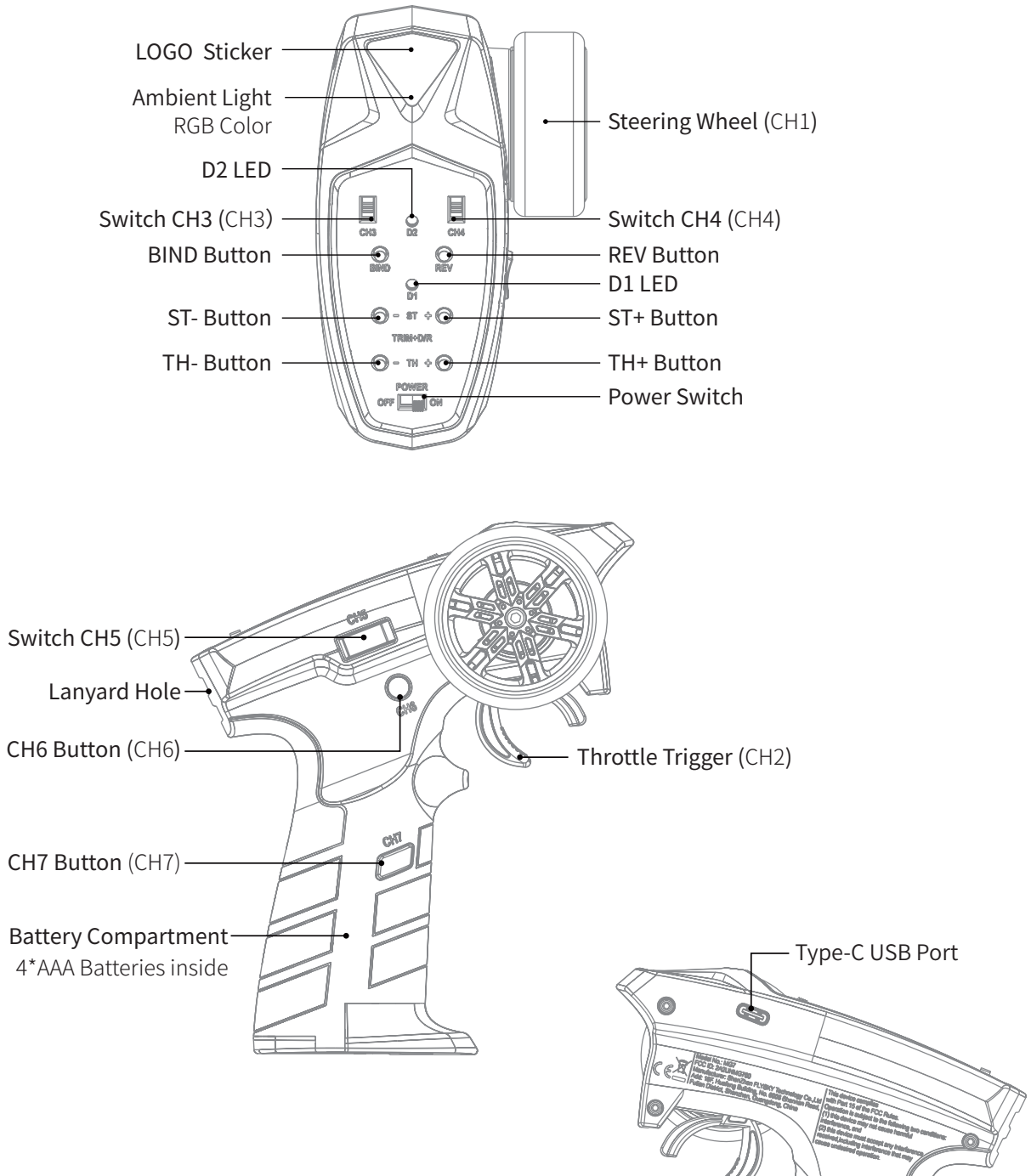

## 2.2 Receiver Overview

Take FS-R7D receiver as an example.

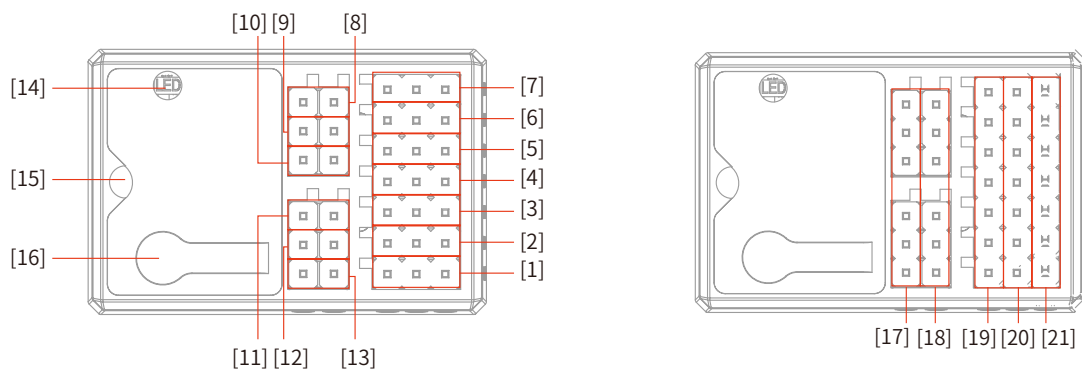

[1]	CH1 (PPM)	[12]	Right turn signal light interface
[2]	CH2	[13]	Left turn signal light interface
[3]	CH3	[14]	LED
[4]	CH4	[15]	Antenna
[5]	CH5	[16]	Bind button
[6]	CH6	[17]	+ (Power anode for light interface)
[7]	CH7	[18]	- (Power cathode for light interface)
[8]	Flash(Strobe) light interface	[19]	S (Signal pin )
[9]	Backup light interface	[20]	+ (Power anode for channel interface)
[10]	Tail light interface	[21]	- (Power cathode for channel interface)
[11]	Headlight interface		

### 2.2.1 The LED Status of the Receiver

The LED status indicates the power supply state of the receiver and its working state.

Off: The receiver is not powered on.

Light on in red: The receiver is connected to the power supply. It works normally.

Fast flashing: The receiver is in the bind mode.

In three- flash-one-off mode: It is waiting for firmware updating or in firmware updating progress.



Slow flashing: The LED flashes slowly when the transmitter is powered off, unbound, or no signal.

### 2.2.2 Interface

All the channel interfaces are 2.54mm\*3 standard pins, and all light interfaces are 2.54mm\*2 standard pins, they are used for connecting the receiver to each terminal part of the model.

### 2.2.3 Antenna

It is an external antenna.

	<p><b>Caution</b></p> <ul style="list-style-type: none"> <li>Do not pull the antenna of the receiver. Do not tie the antenna and the servo cable together.</li> </ul>
	<p><b>Attention</b></p> <ul style="list-style-type: none"> <li>Do not put the antenna close to the metal materials, because this will affect the signal strength of the receiver. Keep the receiver's antenna at least 1cm away from conductive materials such as carbon or metal.</li> </ul>



微信公众号



Bilibili



Website



Facebook

### 3. Getting Started

Prior to operations, please install the battery and connect devices according to the sequence and guide as described in this chapter.

#### 3.1 Transmitter Antenna

The transmitter has a built-in antenna. When the transmitter starts to work, the antenna automatically operate, without additional operations.

#### 3.2 Receiver and Servo Installation

Make sure that the receiver is mounted in an appropriate location within the model, to ensure a stable signal, maximum range and to mitigate external interference, follow these guidelines:

Pay attention to the following when installing the receiver:

1. Make sure the receiver is not installed near motors or other sources of electrical noise.
2. Keep the receivers antenna away from conductive materials such as carbon or metal. To ensure normal function make sure there is a gap of at least 1cm between the antenna and the conductive material.





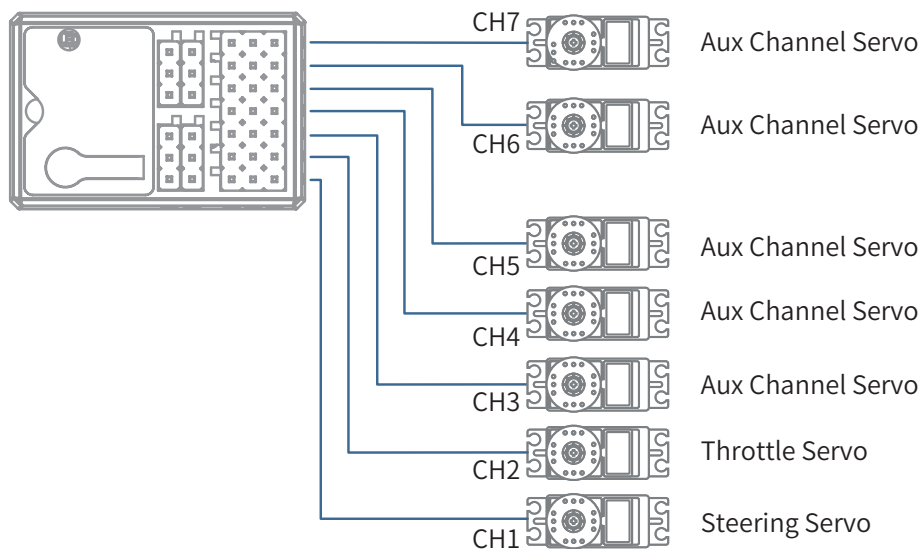

 Caution	• To prevent damage do not power on the receiver during installation.
---	---

Connect the servos to the receiver according to the digram below.





### 3.3 Installing Transmitter Battery

 <b>Danger</b>	• Only use specified battery (X4 AAA batteries).
 <b>Danger</b>	• Do not open, disassemble, or attempt to repair the battery.
 <b>Danger</b>	• Do not crush/puncture the battery, or short the external contacts.
 <b>Danger</b>	• Do not expose to excessive heat or liquids.
 <b>Danger</b>	• Do not drop the battery or expose to strong shocks or vibrations.
 <b>Danger</b>	• Always store the battery in a cool, dry place.
 <b>Danger</b>	• Do not use the battery if damaged.

Battery Type: AAA

Follow the steps below to install the batteries:

1. Open the battery compartment cover.
2. Insert 4 AAA batteries with the correct polarity. Make sure it is connected with the correct polarity to avoid damage.
3. Replace battery compartment cover.

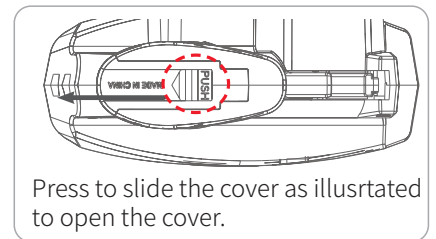

微信公众号



Bilibili



Website



Facebook

## 4. Operation Guide

After setting up, follow the instructions below to use the product.

### 4.1 Power-on

Follow the steps below to turn on the transmitter:

1. Check to make sure that the batteries are fully charged and installed correctly.
2. Toggle the Power Switch to the ON position.

Note: For safety always power on the transmitter before the receiver.

	<b>Attention</b>	• <b>Operate with caution in order to avoid damage or injury.</b>
---	------------------	---

### 4.2 The LED Status of the Transmitter

The D1 LED of this transmitter is used to indicate the status of the transmitter, and the D2 LED is used to indicate the status of the receiver which is in two-way binding with the transmitter, as shown in the following table:

LED	LED Status	Transmitter Status	Note
D1	Flash in green, orange and red repeatedly for 2S	Standby mode (The transmitter is in normal mode after powering on without toggling any control)	
	Slow flash once in red	Switch to CH1	Switch channels (1 to 3~7), used to adjust the positive and negative direction, Trim, and travel of CH3-CH7 channels.
	Slow flash three times in red	Switch to CH3	
	Slow flash four times in red	Switch to CH4	
	Slow flash five times in red	Switch to CH5	
	Slow flash six times in red	Switch to CH6	
	Slow flash seven times in red	Switch to CH7	
	Solid on in green	High voltage	
	Solid on in orange	Medium voltage	
	Slow flash in red	Low voltage	
	Slow flash in green for 3S	2-in-1 mode switching	2-in-1 mode
	Slow flash in green for 3S	2-in-1 mode after powering on	
	Two-flash-one-off in green for 3S	Switching beginner mode	Beginner mode
	Two-flash-one-off in green for 3S	Beginner mode after powering on	
	Fast flash in red	In binding	Binding (or Calibration, refer to funtion description)
	Solid on in red	Binding is successful (or in calibration mode)	
	Fast flash in red & green alternately for 2S	From one-way mode to two-way mode	One-way mode or two-way mode switching
	Fast flash in red & green alternately for 2S	From two-way mode to one-way mode	
	Fast flash in red & green alternately for 3S	In one-way after powering on	
	Three-flash-one-off in red	Receiver is not bound or disconnected	TX and RX disconnect
Red gradual light	In Idle state	Idle alarm	
Orange gradual light	In Sleep state	Sleep mode	
Fast flash in red for 3S	Factory reset	Factory reset	



D2	Slow flash in red	Standard receiver voltage: Low	Voltage state of the receiver connected
	Slow flash in red	2-in-1 receiver with voltage level: Ultra-low	
	Solid on in green	2-in-1 receiver voltage level: High	
	Solid on in orange	2-in-1 receiver voltage level: Medium	
	Solid on in red	2-in-1 receiver voltage level: Low	

### 4.3 Binding

The transmitter and receiver have been pre-bound before delivery. If you are going to rebind, follow the steps below to rebind. The transmitter supports two-way binding and one-way binding. The receiver will return information after the two-way binding is finished.

1. Turn on the transmitter while pressing the BIND button, the transmitter will enter bind mode, at the time, the D1 LED flash fast in red.
2. Put the receiver to enter bind mode.
3. The binding process is completed when the LED of the receiver stops flashing and is solid on (The transmitter will exit the bind mode automatically).
4. Check to make sure the transmitter and receiver are working correctly, if there are any issues or unexpected operation arise, follow the steps above to bind again.

Notes:

1. If the transmitter enters bind mode with one-way mode, the LED of the receiver will be in slow flashing state. After the receiver LED becomes slow flashing, then restart the transmitter. At this time, the receiver LED is solid on, indicating the binding is successful.
2. The binding steps may vary according to the receiver model. Visit the Flysky official website to check the manual of the receiver or other relevant information.

### 4.4 One-way And Two-way Switching

The transmitter supports two communication modes: one-way and two-way. Please select the appropriate communication mode as required (two-way by default).

To switch from two-way to one-way, do as follows:

- Press the REV button, turn the steering wheel of the transmitter clockwise to the maximum travel, and power it on. At this time, the D1 LED flashes red and green alternately, and the buzzer sounds twice shortly in Tone 1 cyclically. It indicates that the transmitter has switched to one-way.

When the transmitter is powered on in one-way mode, the D1 LED will flash red and green alternately for 3S, and the buzzer will sound once shortly in Tone 2.

When switching from one-way to two-way, adopt the same steps as above.

When the transmitter is powered on in two-way mode, the D1 LED flashes green, orange and red alternately for 2S.

Notes:

1. After the switching between one-way and two-way, you need to re-bind the receiver.
2. In the 2-in-1 mode, the switching between one-way and two-way is not allowed.



微信公众号



Bilibili



Website



Facebook

## 4.5 Stick Calibration

Calibrate the maximum and minimum travel of the steering wheel and throttle trigger. The factory calibration is completed. If you need to recalibrate the transmitter, follow the steps below:

1. Turn the transmitter steering wheel clockwise to the maximum travel, push the throttle trigger forward to the maximum travel, and power it on. That is, enter the stick calibration mode. At this time, the D1 LED is solid on in red and the buzzer sounds once shortly with Tone 1 cyclically.
2. Steering wheel calibration: Turn the steering wheel to the maximum and minimum travel in clockwise and counterclockwise respectively, then return to the neutral position.
3. Throttle trigger calibration: Push the throttle trigger forward and backward to the maximum and minimum travel, respectively, then return to the neutral position.
4. Press the BIND button to save and exit the calibration mode.
  - If the calibration is successful, you can press the BIND button to exit the calibration mode, and the buzzer can sound once shortly with Tone 2 cyclically.
  - If the calibration fails, pressing the BIND button is invalid. That is, it is unable to exit the calibration mode.

## 4.6 Ambient Light

The ambient light may be in any of the following states: off, blue solid on, blue gradual light, dazzling gradual light, throttle trigger position indication state, and transmitter voltage indication state. By default, it is off. The switching step is as follows:

- Press and hold the CH7 button of the transmitter for 2S to switch the state. To switch once, press it once. You can perform this operation cyclically.

Notes:

1. For the throttle trigger position indication state, the ambient light is blue when the throttle trigger is in the neutral position, and the light turns from blue to red while in other positions. Perform the stick calibration first prior to using ambient light.
2. For the transmitter voltage indication state, the ambient light color is the same as the D1 LED color of the LED indicating transmitter voltage, refer to 4.2 The LED Status of the Transmitter.

## 4.7 Power Off

Follow the steps below to turn off the system:

1. Disconnect the receiver power.
2. Toggle the transmitter's Power Switch to the OFF position.



**Danger**

- **Make sure to disconnect the receiver power before turning off the transmitter. Failure to do so may lead to damage or serious injury.**



## 5. System Functions

This section focuses on the functions and how to use them.

### 5.1 Channel Description

The transmitter outputs a total of 7 channels, the function assignment and settings are as follows.

Channel	Assigned Control	Function(Normal mode)	Function (2-in-1 mode)
CH1	Steering Wheel	Steering, to control the left/right steering. Turn the steering wheel in clockwise or counterclockwise to control the left/right steering and light signals.	Same as Normal mode
CH2	Thottle Trigger	Thottle, to make the model car forward and backward. Push or pull the throttle trigger to control the model car forward or backward, as well as light signals.	Same as Normal mode
CH3	Switch CH3	Switch the model car speed level. Toggle the control to switch.	Same as Normal mode
CH4	Switch CH4	Switch the model car speed level. Toggle the control to switch.	Switch the ESC battery type
CH5	Switch CH5	Enable/disable the winch function, or switch the model car speed level. Toggle the control to enable/disable the winch function, or switch the speed.	Set the operate mode of ESC
CH6	CH6 Button	Switch the model car speed level. Toggle the control to switch.	Control light signals
CH7	CH7 Button	Four-wheel steering switching channel It is used to set the wheels that control the model car steering, i.e., front wheel steering, front and rear wheels reversal steering, front and rear wheels in the same steering, and rear wheel steering. You can press the control to switch. It is suitable for partial crawler types with steering on both front and rear wheels. Switch one state per press of the control. By default, it is front wheel steering.  Note: When switching, the buzzer's states are indicated by the number of beeps with Tone 1: front wheel steering (beep once), front and rear wheels reversal steering (beep twice), front and rear wheels in the same steering (beep 3 times), and rear wheel steering (beep 4 times).	Switch the drag brake strength of ESC

Note: For details function in 2-in-1 mode, refer to 5.7 2-in-1 mode.

### 5.2 Channel Switching

To switch among CH1 and CH3 to CH7. Follow the step below:

- In case of power-on, press the BIND button twice quickly within 1S. The number of flashes of D1 LED indicates the switch to a specific channel. See 4.2 The LED Status of the Transmitter.

Note: Allowed to switch cyclically.



微信公众号



Bilibili



Website



Facebook

## 5.3 Channel Reverse

To reverse the output direction of the channel.

For 2-in-1 mode, it can adjust the direction of CH1 and CH2 only. For non-2-in-1 mode, it can adjust the direction of CH1-CH7.

- When the steering wheel is at the maximum or minimum travel, press the REV button to adjust CH1 and CH3-CH7 reverse steering. Press once to switch once. By default, it adjusts the steering of CH1. To adjust the steering of CH3-CH7, switch to the corresponding channel firstly. When only CH7 is set to rear wheel steering mode, CH7 can be reversed by pressing the REV button under CH1. When the reverse steering action takes effect, the buzzer will beep once shortly in Tone 1.
- When the throttle trigger is at maximum or minimum travel and the steering wheel is in the neutral position, press the REV button to reverse CH2. To switch once, press once. When the channel reverse steering action takes effect, the buzzer will beep once shortly in Tone 2.

## 5.4 Trim Setting

This function is used to adjust the channel trim.

For 2-in-1 mode, only CH1-CH4 trim can be adjusted. For non-2-in-1 mode, CH1-CH7 trim can be adjusted.

- When the steering wheel is in the neutral position, press the ST+/- button to adjust CH1 and CH3-CH7 trim. By default, the CH1 trim is adjusted. To adjust CH3-CH7, first switch to the corresponding channel. When CH7 is set to rear wheel steering only, CH7 trim can be adjusted by pressing the ST+/- button in CH1.
- When the throttle trigger is in the neutral position, press the TH+/- button to adjust the CH2 trim.

ST+/TH+: Press to increase the trim value. ST-/TH-: Press to decrease the trim value. The trim range: -120 us~120 us. The step is 4us. By default, it is 0.

When the trim setting action takes effect, the buzzer will beep once shortly in Tone 1. You can press and hold it for quick adjustment. The buzzer will beep twice shortly when the trim is over Neutral. The buzzer will sound once for seconds when it reaches the end.

## 5.5 D/R Setting

This function is used to adjust the travel range value of the channel.

For 2-in-1 mode, only CH1-CH4 travel range value can be adjusted. For non-2-in-1 mode, CH1-CH7 travel range value can be adjusted.

- When the steering wheel is located in the maximum travel or minimum travel, press the ST+/- button to adjust CH1 and CH3-CH7 travel range value. By default, the CH1 travel range value is adjusted. To adjust CH3-CH7, first switch to the corresponding channel. When CH7 is set to rear wheel steering only, CH7 travel range value can be adjusted by pressing the ST+/- button in CH1.
- When the throttle trigger is at the maximum or minimum travel, press the TH+/- button to adjust CH2 travel range value.

ST+/TH+: Increase the travel value. ST-/TH-: Decrease the travel value. Travel range: 0-120%, by default, it is 100%, the step is 5%.

When the servo setting action takes effect, the buzzer will beep once shortly in Tone 2. You can press and hold it for quick adjustment. The buzzer will sound for seconds when it reaches the end.



## 5.6 Switching Model

The transmitter supports five sets of models.

- Press and hold the CH6 and CH7 buttons of the transmitter and power it on. That is, it enters the mode of switching model. When the switching is successful, the buzzer will sound at different times in prompt tones. See the following table.

Model	Buzzer (Sound in Tone 2)
Model1	Sound once shortly
Model2	Sound twice shortly
Model3	Sound three times shortly
Model4	Sound four times shortly
Model5	Sound five times shortly

Notes:

- After the model is switched successfully, the RF module changes into two-way mode, and the transmitter enters standby mode.
- Allowed to switch cyclically.

## 5.7 2-in-1 Mode

The transmitter supports two modes in two-way communications: 2-in-1 mode and normal mode. By default, it is normal mode.

- Press and hold the BIND and CH6 buttons of the transmitter, and power it on. At this time, the D1 LED flashes slowly for 3S, and the buzzer beeps twice in Tone 2, and the transmitter will be in 2-in-1 mode or normal mode. You can power it off and save the settings. In case of power-on, if the D1 LED flashes slowly in green for 3S and the buzzer beeps twice in Tone 2, this is 2-in-1 mode; if the D1 LED flashes green, orange and red quickly for 2S, this is normal mode.

In 2-in-1 mode, the function settings are as follows:

- Control the model car lights by pressing the CH6 button. It is reversed once when you press once.
- Set the ESC operation mode through the CH5 switch: Forward/backward/brake mode or forward/backward mode. By default, it is forward/backward/brake mode. It is switched once when you toggle the CH5 switch once. When the mode is switched to forward/backward, the buzzer will beep once in Tone 1. Otherwise, it beeps twice.
- Toggle the CH4 switch to switch the ESC battery type: Li-ion and Ni-MH. By default, it is Li-ion. It is switched once when you toggle the CH4 switch once. When switching to Li-ion battery, the buzzer will beep twice in Tone 2. Otherwise, it beeps once.
- Switch the ESC drag brake strength by pressing CH7 button: 0%, 50%, 75% and 100%. By default, it is 0%. The drag brake strength is switched once when you press it once. When the strength is switched to 0%, the buzzer beeps once in Tone 1. When the strength is switched to 50%, the buzzer beeps twice. When the strength is switched to 75%, the buzzer beeps for three times. When the strength is switched to 100%, the buzzer beeps for four times.

## 5.8 Beginner Mode

This transmitter supports the beginner mode.

- Press and hold the CH6 button of the transmitter, turn the steering wheel to the maximum travel in counterclockwise, and power it on, the transmitter will be the beginner mode or the normal mode. If the switching



微信公众号



Bilibili



Website



Facebook

is successful, The D1 LED works in two-flash-one-off mode in green for 3S cyclically and the buzzer will sound once shortly with Tone 2.

In case of power-on, you can judge the mode of the transmitter according to the D1 LED status and buzzer sound: If the D1 LED works in two-flash-one-off mode in green for 3S cyclically and the buzzer sounds once shortly with Tone 2, it is the beginner mode; if the D1 LED quickly flashes green, orange and red for 2S, it is the normal mode.

Notes:

1. After switching to the beginner mode, the throttle D/R is a half of normal mode.
2. The setting will be save when the transmitter turns off.

## 5.9 Failsafe

It is used for the safety of the model and the operator when the receiver cannot receive signals from the transmitter normally (out-of-control).

By default, it is not set. In this case, the receiver channel has no output.

- In the normal power-on state, set the control corresponding to the channel to be configured with failsafe to the preset position. Then, press and hold the Bind button for 3S to set the channel value of the current output to the failsafe value. When the setting is successful, the buzzer will sound once for seconds with Tone 1.

Notes:

1. If the transmitter binds with a 2-in-1 ESC receiver, the receiver will automatically enter the brake mode after out-of-control.
2. Restore to the default setting in case of re-binding.

## 5.10 Reset Data

To reset the function data of the model using currently to default value.

- Press and hold the BIND and CH7 buttons of the transmitter, and power it on, to reset the data. When the setting is successful, the buzzer will sound once for seconds with Tone 2.

Note: These will not be reset, such as the failsafe setting, binding information, 2-in-1 mode and one-way/two-way data.

## 5.11 Idle Alarm

The transmitter will go into idle alarm state when there is no operation over 10 minutes.

- When the transmitter is in idle alarm state, the D1 LED will be in red gradual light state, and the buzzer will sound twice quickly in cycle with Tone 1 and Tone 2 for prompt. Operations of any control on the transmitter will cancel the alarm, as a result of the exit of the idle alarm state.





---

---

## 5.12 Sleep Mode

When a 2-in-1 receiver has connected and the transmitter has been in idle alarm state over 2 minutes, it will enter the sleep mode.

- In this mode, the D1 LED will be in orange gradual light state, the buzzer and RF will turn off. The transmitter is not responsive in case of operations of any control. To exit the sleep mode, power off the transmitter and restart it.

## 5.13 Offline Prompt

When the transmitter is in two-way mode, once it detects the bound receiver has turned off, or disconnected over 2S, the D1 LED will work in three-flash-one-off mode for prompt.

## 5.14 Transmitter Voltage Alarm

It is used to indicate the transmitter voltage state. It gives an alarm when the voltage is medium or low.

- Transmitter Voltage  $> 5\text{ V}$ : The D1 LED is solid on in green.  $4.2\text{ V} < \text{Transmitter Voltage} < 5\text{ V}$ : The D1 LED is solid on in orange. Transmitter Voltage  $< 4.2\text{ V}$ : The D1 LED flashes slowly in red and the buzzer beeps once shortly in Tone 1 cyclically.

## 5.15 Receiver Voltage Alarm

It is used to indicate the voltage state of the connected receiver and alarm.

- For standard receivers, when the voltage is lower than  $4.2\text{ V}$ , the D2 LED flashes slowly in red and the buzzer beeps once in Tone 1 cyclically.
- For 2-in-1 receivers, when the voltage is high, the D2 LED is solid on in green; when the voltage is medium, the D2 LED is solid on in orange; when the voltage is low, the D2 LED is solid on in red and the buzzer beeps twice shortly in Tone 1 cyclically; when the voltage is ultra-low, the D2 LED flashes slowly in red and the buzzer beeps for three times shortly in Tone 1 cyclically.

## 5.16 Factory Reset

This function is used to restore the transmitter to the factory default state.

- Press and hold REV and CH7 buttons of the transmitter and power it on. That is, restore to the factory default state. When the setting is successful, the D1 LED quickly flashes in red for 3S and the buzzer sounds twice for seconds with Tone 2.



微信公众号



Bilibili



Website



Facebook

## 6. FS-R7D Function Instructions

This section instruct how to use FS-R7D receiver and the attentions.

FS-R7D is a light group 7-channel receiver in compliance with the ANT protocol with a single external antenna, two-way transfer-back function. It can output PWM signals and light control signals, featuring the compact design. It can adapte to a variety of car models.

Note: Refer to 2.2 receiver overview for the information of the receiver's interfaces.

### 6.1 Attentions

- Make sure the product is installed and calibrated correctly, failure to do so may result in serious injury.
- Make sure the receiver's battery is disconnected before turning off the transmitter, failure to do so can result out of control. Unreasonable setting of the Failsafe may cause accidents.
- Make sure the receiver is mounted away from motors, electronic speed controllers or any device that emits excessive electrical noise.
- Keep the receiver's antenna at least 1cm away from conductive materials such as carbon or metal.
- Do not power on the receiver during the setup process to prevent loss of control.

### 6.2 Binding Instruction

If needs to rebind the receiver and the transmitter, refer to 4.3 Binding for details.

### 6.3 Car Light Control

The lights are mainly controlled through CH1 and CH2, i.e. the working status of the lights is controlled by hand wheel and trigger.

The details are as follows:

Name	Working Mode	Trigger Condition	Remarks
Left Turn Light	Slow flash	Left turn	
Right Turn Light	Slow flash	Right turn	
Headlight	Solid ON	Steering wheel clockwise fast rotation for three times	After setting the channel reverse, it is counterclockwise.
Strobe Light	Fast Flash	Steering wheel counterclockwise fast rotation for three times	After setting the channel reverse, it is clockwise.
Tail Light	Solid ON	Brake	
Backup Light	Solid ON	Back up	

Notes:

1. After the receiver is powered on, all lights perform self-test immediately. After the lights are on for 1 second, they are off.
2. By default, the headlights and strobe lights are off.
3. Steering CH1 and throttle CH2 can automatically identify the neutral position.



---

---

## 6.4 Firmware Update

The firmware of this receiver is updated through the FlyskyAssistant (Only version 3.0 or later is supported. The firmware of FlyskyAssistant is available on the Flysky official website).

This receiver can be updated via the following two ways:

1. After the binding between the transmitter and the receiver (the LED of the receiver is solid on), connect the transmitter to the computer, then open the FlyskyAssistant on the computer to update the firmware.
2. Connect the transmitter to the computer. Then put the receiver to enter the forced update mode by referring to the following way (The LED of the receiver works in three-flash-one-off mode repeatedly). Afterwards, open the FlyskyAssistant on the computer to update the firmware.
  - Power on the receiver first, then press and hold the BIND button for more than ten seconds, when the LED of the receiver works in three-flash-one-off mode repeatedly, then release the BIND button.

## 6.5 Failsafe

This receiver supports two failsafe modes: ON and OFF. You can set it at transmitter side. Please refer to Failsafe in the previous description.



微信公众号



Bilibili



Website



Facebook

## 7. Customized Definition

### 7.1 Steering Wheel Angle Adjustment Instruction

Follow the steps below to adjust the angle of the steering wheel.

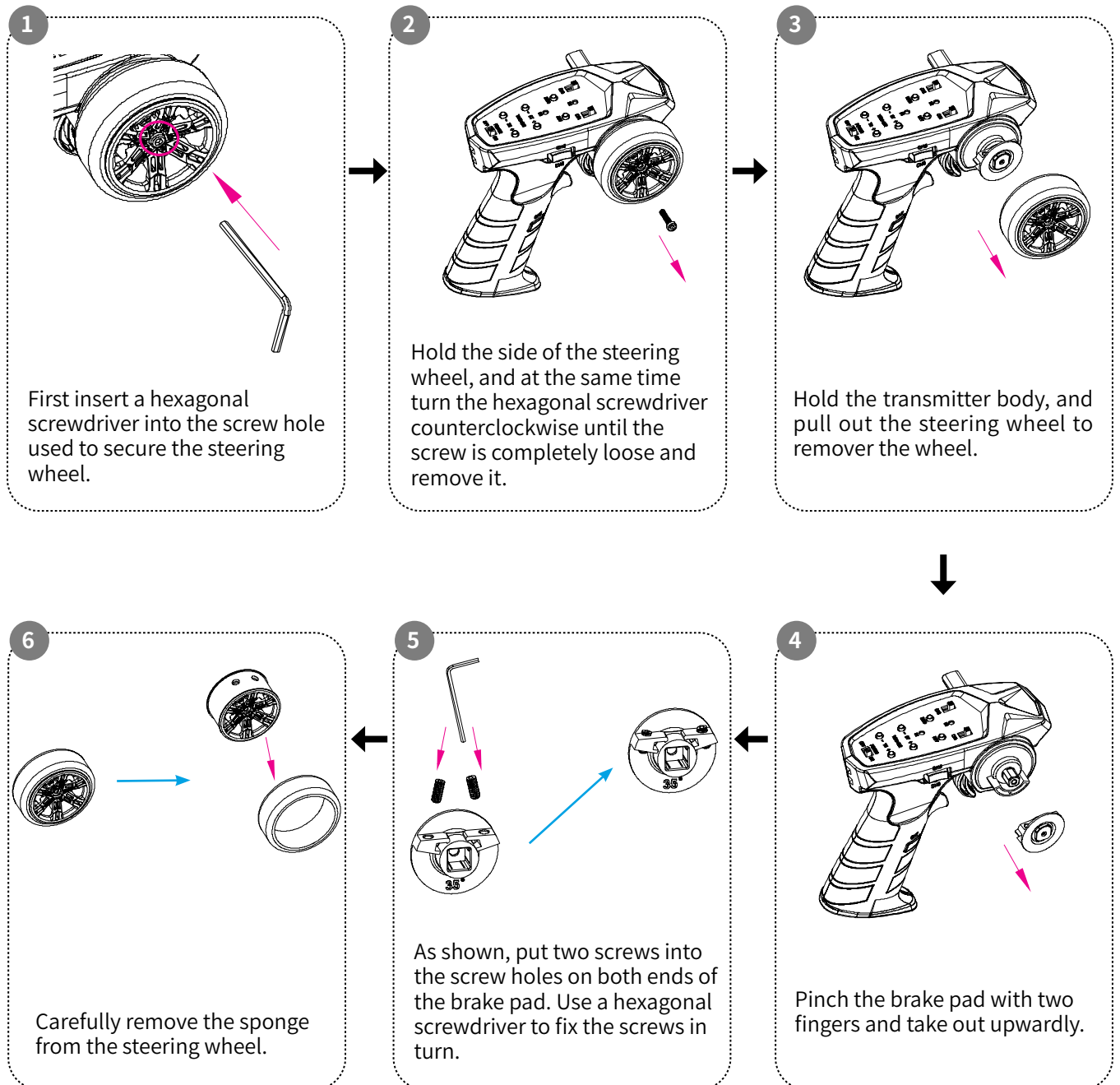

7

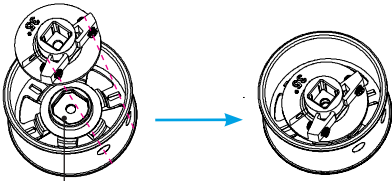

The slot of steering wheel

Align screws screwed in the brake pad with the screw holes on the steering wheel. At the same time, press the brake pad into the slot of the steering wheel firmly until the brake pad is fixed.

8

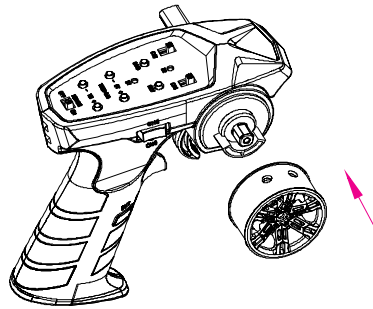

Align the steering wheel to steering wheel roller, then press the steering wheel to fix it.

9

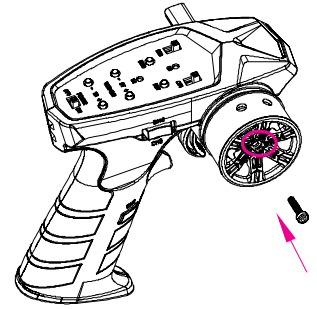

Insert the screw into the screw hole used to secure the steering wheel, then align the hexagonal screwdriver with the hexagonal hole in the head of the screw, hold the side of the steering wheel and turn the screwdriver clockwise until the screw is secured.



12

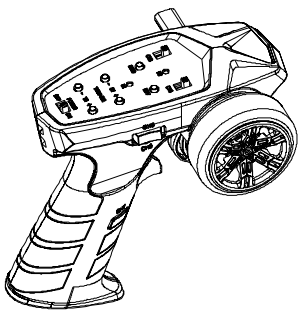

The installation is complete. After finishing the stick calibration, the transmitter can be used normally.

11

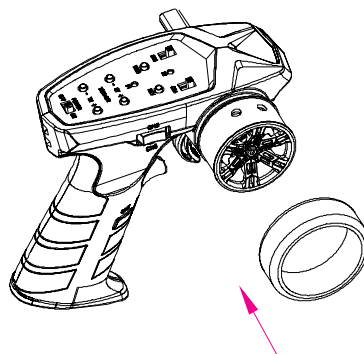

Reinstall the steering wheel sponge.

10

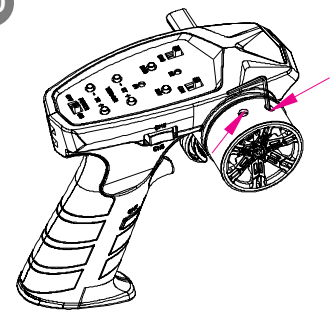

Insert the hexagonal screwdriver into the two adjustment holes at the top of the steering wheel and adjust the rotation angle of the steering wheel as needed.

- The tighter the screw, the smaller the rotation angle. The looser the screw, the larger the rotation angle.



微信公众号



Bilibili



Website



Facebook

## 8. Specifications

This section contains FS-MG7 transmitter and FS-R7D receiver specifications.

### 8.1 Transmitter Specifications

Product Model	FS-MG7
Compatible Receivers	FS-R7D, receivers with ANT protocol
Compatible Models	Cars or boats
Number of Channels	7
RF	2.4GHz ISM
Maximum Power	< 20dBm (e.i.r.p.) (EU)
2.4GHz Protocol	ANT
Distance	>150m (Ground distance without interference)
Resolution	4096
Input Power	4~9V DC/AAA*4
Working Current	83mA/6V
Low Voltage Alarm	< 4.2V
Antenna	Single built-in antenna
Online Update	No
Temperature Range	-10°C ~ +60°C
Humidity Range	20% ~ 95%
Color	Black
Dimensions	120.5*72.6*145.2mm
Weight	134g
Certifications	CE, FCC ID: 2A2UNMG700



## 8.2 Receiver Specifications

Product Model	FS-R7D
Compatible Transmitters	FS-MG7
Compatible Models	Cars
PWM Channels	7
Number of Lights	6
RF	2.4GHz ISM
2.4GHz Protocol	ANT
Input Power	3.5 ~ 9V /DC
Working Current	< 90mA/5V
Maximum Power	< 20dBm (e.i.r.p.) (EU)
Distance	>300m (Ground distance without interference)
Antenna	Single external antenna(Coaxial)
Data Output	PWM/PPM
Resolution	4096
Temperature Range	-10°C ~ +60°C
Humidity Range	20% ~ 95%
Online Update	Yes
Dimensions	35*23.3*13.3mm
Weight	8g
WaterProof	PPX4
Certifications	CE, FCC ID: 2A2UNR7D00



微信公众号



Bilibili



Website



Facebook

## 9. Package Contents

This section contains FS-MG7 transmitter package contents.

Number	Name	Quantity
1	FS-MG7 Transmitter	1
2	FS-R7D Receiver	1
3	Quick Start Guide	1
4	Screws ( Using for the steering wheel angle adjustment)	2





---

---

## 10. Certifications

### 10.1 DoC Declaration

Hereby, we declare that the Radio Equipment [FS-MG7] is in compliance with RED 2014/53/EU.

The full text of the EU DoC is available at the following internet address: [www.flyskytech.com/info\\_detail/10.html](http://www.flyskytech.com/info_detail/10.html)

### 10.2 CE Warning

The antenna(s) used for this transmitter must be installed to provide a separation distance of at least 20 cm from all persons and must not be co-located or operating in conjunction with any other transmitter. End-users and installers must be provided with antenna installation instructions and transmitter operating conditions for satisfying RF exposure compliance.

### 10.3 FCC Statement

This equipment has been tested and found to comply with the limits for a Class B digital device pursuant to part 15 of the FCC rules. These limits are designed to provide reasonable protection against harmful interference in a residential installation. This equipment generates, uses and can radiate radio frequency energy and, if not installed and used in accordance with the instructions, may cause harmful interference to radio communications. However, there is no guarantee that interference will not occur in a particular installation. If this equipment does cause harmful interference to radio or television reception, which can be determined by turning the equipment off and on, the user is encouraged to try to correct the interference by one or more of the following measures:

- Reorient or relocate the receiving antenna.
- Increase the separation between the equipment and receiver.
- Connect the equipment into an outlet on a circuit different from that to which the receiver is connected.
- Consult the dealer or an experienced radio/TV technician for help.

To assure continued compliance, any changes or modifications not expressly approved by the party responsible for compliance could void the user's authority to operate this equipment. (Example use only shielded interface cables when connecting to computer or peripheral devices).

This equipment complies with Part 15 of the FCC Rules. Operation is subject to the following two conditions:

- (1) This device may not cause harmful interference, and
- (2) This device must accept any interference received, including interference that may cause undesired operation.

#### Caution!

The manufacturer is not responsible for any radio or TV interference caused by unauthorized modifications to this equipment. Such modifications could void the user authority to operate the equipment.

1. Move all your channels to the desired position.
2. Select [All channels] and then [Yes] in the confirmation box.



微信公众号



Bilibili



Website



Facebook

## 10.4 Environmentally friendly disposal

Old electrical appliances must not be disposed of together with the residual waste, but have to be disposed of separately. The disposal at the communal collecting point via private persons is for free. The owner of old appliances is responsible to bring the appliances to these collecting points or to similar collection points. With this little personal effort, you contribute to recycle valuable raw materials and the treatment of toxic substances.

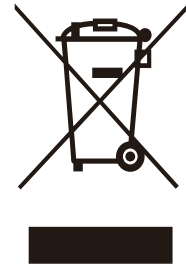

### CAUTION

RISK OF EXPLOSION IF BATTERY IS REPLACED BY AN INCORRECT TYPE.  
DISPOSE OF USED BATTERIES ACCORDING TO THE INSTRUCTIONS

Figures and illustrations in this manual are provided for reference only and may differ from actual product appearance. Product design and specifications may be changed without notice.



# FLYSKY



微信公众号



Bilibili



Website



Facebook



CE, FCC ID: 2A2UNMG700

[www.flysky-cn.com](http://www.flysky-cn.com)

Copyright ©2022 Flysky Technology co., Ltd.

Release date: 2022-11-21

Manufacturer: ShenZhen FLYSKY Technology Co., Ltd.  
Address: 16F, Huafeng Building, No. 6006 Shennan Road, Futian District, Shenzhen, Guangdong, China