

TREX 600XN

INSTRUCTION MANUAL

使用說明書

RH60N06XT
RH60N07XT



Nitro at Its Finest!
完美演繹動感美學

| Contents | |
|-----------------|---|
| 1 | INTRODUCTION 前言 |
| 1~2 | SAFETY NOTES 安全注意事項 |
| 3 | EQUIPMENT REQUIRED FOR ASSEMBLY 自備設備 |
| 3 | PACKAGE ILLUSTRATION 包裝說明 |
| 4 | MODEL STANDARD EQUIPMENT DIFFERENCE 標準配備版本說明 |
| 5 | SAFETY CHECK BEFORE FLYING 飛行前安全檢查重要事項 |
| 6~22 | ASSEMBLY SECTION 組裝說明 |
| 23~24 | EQUIPMENT INSTALLATION 各項設備配圖 |
| 24 | CANOPY ASSEMBLY 機頭罩安裝 |
| 25 | ELECTRIC EQUIPMENT ILLUSTRATION 電子設備建議配圖標示 |
| 25~26 | MICROBEAST PLUS FLYBARLESS MANUAL 無平衡翼系統使用說明 |
| 27 | SERVO SETTING AND ADJUSTMENT 伺服器設定調整 |
| 27 | ADJUSTMENTS FOR GYRO AND TAIL NEUTRAL SETTING 陀螺儀與尾翼中立點設定調整 |
| 28 | PITCH AND THROTTLE SETTING 主旋翼螺距與油門設定 |
| 28 | GOVERNOR INSTRUCTION MANUAL 定速器安裝使用說明 |
| 30~31 | 2 IN 1 VOLTAGE REGULATOR INSTRUCTION MANUAL 2合1降壓器安裝使用說明 |
| 31~35 | FLIGHT ADJUSTMENT AND SETTING 飛行動作調整與設定 |
| 36 | TROUBLESHOOTING 飛行中狀況排除 |

Thank you for purchasing Align products. Please read the manual carefully before installing and be sure to retain the manual for future reference. All pictures shown are for illustration purpose only. Actual product may vary due to product enhancement. Specifications, contents of parts and availability are subject to change, ALIGN RC is not responsible for inadvertent errors in these publications.



承蒙閣下選用亞拓遙控世界系列產品，謹表謝意。

使用前，請務必詳閱本說明書，相信一定能夠給您帶來相當大的幫助，也請您妥善保管這本說明書，以做為日後參考。本公司將不對此印刷物之異動負責，也無法主動通知消費者任何更新或異動。所有圖片僅用於展示目的。產品可能因改良而有些不同。本說明書內記載的材質、規格或零件包裝之內容物如有異動，請依亞拓官網公告為主。

Thank you for buying ALIGN Products. The T-REX 600XN Helicopter is designed as an easy to use, full featured Helicopter R/C model capable of all forms of rotary flight. Please read the manual carefully before assembling the model, and follow all precautions and recommendations located within the manual. Be sure to retain the manual for future reference, routine maintenance, and tuning. The T-REX 600XN is a new product developed by ALIGN. It features the best design available on the R/C helicopters market to date, providing flying stability for beginners, full aerobatic capability for advanced fliers, and unsurpassed reliability for customer support.

感謝您選購亞拓產品。為了讓您容易方便的使用 T-REX 600XN 直昇機，請您詳細的閱讀完這本說明書之後再進行組裝以及操作這台直昇機。同時請您妥善的保存這本說明書，作為日後進行調整以及維修的參考。T-REX 600XN 是由亞拓自行研發的新產品，不論您是需求飛行穩定性的初學者或是追求性能的飛行愛好者，T-REX 600XN 將是您最佳的選擇。

WARNING LABEL LEGEND 標誌代表涵義

| | |
|--|--|
|  | Do not attempt under any circumstances. 在任何禁止的環境下，請勿嘗試操作。 |
|  | Mishandling due to failure to follow these instructions may result in damage or injury. 因為疏忽這些操作說明，而使用錯誤可能造成財產損失或嚴重傷害。 |
|  | Mishandling due to failure to follow these instructions may result in danger. 因為疏忽這些操作說明，而使用錯誤可能造成危險。 |

IMPORTANT NOTES 重要聲明

R/C helicopters, including the T-REX 600XN are not toys. R/C helicopter utilize various high-tech products and technologies to provide superior performance. Improper use of this product can result in serious injury or even death. Please read this manual carefully before using and make sure to be conscious of your own personal safety and the safety of others and your environment when operating all ALIGN products. Manufacturer and seller assume no liability for the operation or the use of this product. This product is intended for use only by adults with experience flying remote control helicopters at a legal flying field. After the sale of this product we cannot maintain any control over its operation or usage.

As the user of this product, you are solely responsible for operating it in a manner that does not endanger yourself and others or result in damage to the product or the property of others.

T-REX 600XN 遙控直昇機並非玩具，它還結合了許多高科技產品所設計出來的休閒用品，所以商品的使用不當或不熟悉都可能造成嚴重傷害甚至死亡，使用之前請務必詳讀本說明書，勿輕忽並注意自身安全。注意！任何遙控直昇機的使用，製造商和經銷商是無法對使用者於零件使用的損耗異常或組裝不當所發生之意外負任何責任，本產品是提供給有操作過模型直昇機經驗的成人或有相當技術的人員在旁指導於當地合法遙控飛行場飛行，以確保安全無虞下操作使用，產品售出後本公司將不負任何操作和使用控制上的任何性能與安全責任。

作為本產品的使用者，您，是唯一對於您自己操作的環境及行為負全部的責任之人。

We recommend that you obtain the assistance of an experienced pilot before attempting to fly our products for the first time. A local expert is the best way to properly assemble, setup, and fly your model for the first time. The T-REX 600N requires a certain degree of skill to operate, and is a consumer item. Any damage or dissatisfaction as a result of accidents or modifications are not covered by any warranty and cannot be returned for repair or replacement. Please contact our distributors for free technical consultation and parts at discounted rates when you experience problems during operation or maintenance. As Align Corporation Limited has no control over use, setup, final assembly, modification or misuse, no liability shall be assumed nor accepted for any resulting damage or injury. By the act of use, setup or assembly, the user accepts all resulting liability.

模型商品屬於高風險操作技術且為消耗性之商品，如經拆裝使用後，會造成不等情況零件損耗，任何使用情況所造成商品不良或不滿意，將無法於保固條件內更換新品或退貨，如遇有使用操作維修問題，本公司全省分公司或代理商將提供技術指導、特價零件供應服務。對使用者的不當使用、設定、組裝、修改、或操作不良所造成的破損或傷害，本公司無法控制及負責。任何使用、設定、組裝、修改、或操作不良所造成的破損、意外或傷害，使用者應承擔全部責任。

SAFETY NOTES 安全注意事項



· Fly only in safe areas, away from other people. Do not operate R/C aircraft within the vicinity of homes or crowds of people. R/C aircraft are prone to accidents, failures, and crashes due to a variety of reasons including, lack of maintenance, pilot error, and radio interference. Pilots are responsible for their actions and damage or injury occurring during the operation or as a result of R/C aircraft models.

· Prior to every flight, carefully check rotorhead spindle shaft screws and tail blade grip screws, linkage balls and screws, ensure they are firmly secured.

· 遙控模型飛機、直昇機屬高危險性商品，飛行時務必遠離人群，人為組裝不當或機件損壞、電子控制設備不良，以及操作上的不熟悉、都有可能導致飛行失控損傷等不可預期的意外，請飛行者務必注意飛行安全，並瞭解自負疏忽所造成任何意外之責任。

· 每趟飛行前仔細檢查，主旋翼夾座橫軸螺絲、尾旋翼夾座螺絲，以及機身各部位球頭、螺絲，確實上膠樂才能升空飛行。

**LOCATE AN APPROPRIATE LOCATION 遠離障礙物及人群**

R/C helicopters fly at high speed, thus posing a certain degree of potential danger. Choose a legal flying field consisting of flat, smooth ground without obstacles. Do not fly near buildings, high voltage cables, or trees to ensure the safety of yourself, others and your model. For the first practice, please choose a legal flying field. Do not fly your model in inclement weather, such as rain, wind, snow or darkness.

真昇機飛行時具有一定的速度，相對的也潛在著危險性，場地的選擇也相對的重要，請嚴守當地法規到合法遙控飛行場地飛行。務必選擇在空曠合法遠程飛行場地，並必須注意周圍沒有行人、高樓、建築物、高壓電線、樹木等等，避免操控的不當造成自己與他人財產的損壞。請勿在下雨、打雷等惡劣天氣下操作，以確保本身及機體的安全。

**NOTE ON LITHIUM POLYMER BATTERIES 鋰聚電池注意事項**

Lithium Polymer batteries are significantly more volatile than alkaline or Ni-Cd/Ni-MH batteries used in RC applications. All manufacturer's instructions and warnings must be followed closely. Mishandling of Li-Po batteries can result in fire. Always follow the manufacturer's instructions when disposing of Lithium Polymer batteries.

鋰聚電池跟一般在RC使用的鹼性電池、鎳鎘電池、鎳氫電池比較起來是相對危險的。請嚴格遵守避擊電池說明書之使用注意事項，不恰當使用鋰聚電池，可能造成火災並損及生命財產安全，切勿大意！

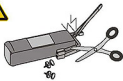
**PREVENT MOISTURE 遠離潮濕環境**

R/C models are composed of many precision electrical components. It is critical to keep the model and associated equipment away from moisture and other contaminants. The introduction or exposure to water or moisture in any form can cause the model to malfunction resulting in loss of use, or a crash. Do not operate or expose to rain or moisture.

真昇機內部也是由許多精密的電子零組件組成，所以必須絕對的防止潮濕或水氣，避免在浴室或雨天時使用，防止水氣進入機身內部而導致機件及電子零件故障而引發不可預期的意外！

**PROPER OPERATION 勿不當使用本產品**

Please use the replacement of parts on the manual to ensure the safety of instructors. This product is for R/C model, so do not use for other purpose.

請勿自行改造加工，任何的升級改裝或維修，請使用亞拓產品目錄中的零件，以確保結構的安全。請審閱於產品限外操作，請勿過載使用，並勿用於安全、法令外其它非法用途。

**OBTAIN THE ASSISTANCE OF AN EXPERIENCED PILOT 避免獨自操控**

Before turning on your model and transmitter, check to make sure no one else is operating on the same frequency. Frequency interference can cause your model, or other models to crash. The guidance provided by an experienced pilot will be invaluable for the assembly, tuning, trimming, and actual first flight or unforeseen danger may happen. (Recommend you to practice with computer-based flight simulator.)

至飛行場飛行前，需確認是否有相同頻率的同好正進行飛行，因為開關相同頻率的發射器將導致自己與他人立即墜于墜等意外危險。遙控飛機操控技巧在學飛初期有者一定的難度，最需避免獨自操作飛行，需有經驗的人士在旁指導，才可以操控飛行，否則將可能造成不可預期的意外發生。（建議電腦模擬器及老手指導是入門必經的選擇）

**SAFE OPERATION 安全操作**

Make sure to always be aware to keep your eyes and body away from blades rotation. Do not attempt to grab or make contact with the helicopter while the main blades are in motion. During take-off, landing, and flight, be sure to keep the helicopter away from all obstacles. Operators must stand at least 10 meters away from the helicopter. Never take your eyes off the model or leave it unattended while it is turned on, and immediately turn off the model and transmitter when you have landed the model. Operate this unit within your ability, do not fly under tired condition, improper operation may cause in danger, and always to avoid injury caused by loose parts due to improper assembly or any unforeseen dangers.

請隨時注意，無論在任何時候，都不能將旋轉中的旋翼對者眼睛，嚴禁用手抓取運行中的真昇機，當主旋翼轉動後，或起飛/試飛時，務必遠離障礙物，站立位置必需距離10公尺以上，不可在視線範圍外進行飛行，降落後也請馬上關掉真昇機和遙控器電源。操作這台真昇機需要一定操控技術及能力，避免因為為組裝不當造成零件鬆落，而引發不可預期的財物及人員損傷，並請盡量自身情況，過於疲勞、精神不佳或不當操作，都可能引誘不可預期的意外發生。

**ALWAYS BE AWARE OF THE ROTATING BLADES 遠離旋轉中零件**

During the operation of the helicopter, the main rotor and tail rotor will be spinning at a high rate of speed. The blades are capable of inflicting serious bodily injury and damage to the environment. Be conscious of your actions, and careful to keep your face, eyes, hands, and loose clothing away from the blades. Always fly the model a safe distance from yourself and others, as well as surrounding objects.

真昇機主旋翼與尾旋翼旋轉時會以高轉速下進行，在高轉速下的旋翼會造成自己與他人在身體上或環境上的嚴重損傷，請勿觸摸旋轉中的主旋翼與尾旋翼，並保持安全距離以避免造成危險及損壞。

**KEEP AWAY FROM HEAT 遠離熱源**

R/C models are made of various forms of plastic. Plastic is very susceptible to damage or deformation due to extreme heat and cold climate. Make sure not to store the model near any source of heat such as an oven, or heater. It is best to store the model indoors, in a climate-controlled, room temperature environment.

遙控飛機多半是以 Pa 纖維或聚乙烯、電子商品為主要材質，因此要盡量遠離熱源、日曬，以避免因高溫而變形甚至熔毀損壞的可能。



RADIO TRANSMITTER AND ELECTRONIC EQUIPMENT REQUIRED FOR ASSEMBLY 自備遙控及電子設備



Transmitter (7-channel or more, Helicopter system)

發射機(七動以上直昇機模式遙控器)



Receiver(7-channel or more)

接收機(七動以上)



or



Remote Receiver

衛星天線



Microbeast PLUS Flybarless System x 1

微平旋翼系統 x 1



Engine Starter

引擎啟動器



Fuel Pump

加油器



Engine Fuel

引擎燃油



2S1P 7.4V LI-Po 1900-

2600mAh Battery

2S1P 7.4V LI-Po 1900-2600mAh 電池

ADDITIONAL TOOLS REQUIRED FOR ASSEMBLY 自備工具

[H70118]

Swashplate Leveler

十字盤校正器

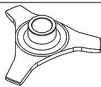

[HET80001]

AP800 Digital Pitch Gauge

AP800 數位傾角尺



[HETMT901]

Multi-function Tester

多功能檢測計



Philips Screw Driver

十字螺絲起子

φ 3.0/φ 1.8mm



Cutter Knife

刀子



Hexagon Screw Driver

六角螺絲起子

3mm/2.5mm/

2mm/1.5mm



Needle Nose Pliers

尖嘴鉗



Oil

潤滑油



CA Glue

瞬間膠



Grease

潤滑油



PACKAGE ILLUSTRATION

包裝說明

600 Carbon Fiber Blade X 1set

600 碳纖維主皮翼 X 1組

B6M
2 In 1 Voltage
Regulator combo x 1

二合一降壓器 Combo x 1

600NT12

Governor Sensor X 1

定速感知器 X 1

Optional Equipment

選購品

50 Muffler

50 高效加速管

Quick Finder

零件快速碼



Optional Equipment

選購品

ALIGN 55 Engine

ALIGN 55引擎

600NH18 600NB13
600NB10 600NH17
600NB11 700HG3
600NB2 600NT9
700NB8 60HT6A
600NB14 600NT12
600NB15 600NZ

DS830M High Voltage Brushless Servo x 3

DS830M 高壓無刷伺服器 x 3

DS835M High Voltage Brushless Servo x 1

DS835M 高壓無刷伺服器 x 1

DS530 Digital Servo x 1

DS530 數位伺服器 x 1

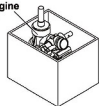

The T-REX 600XN Combo includes additional electronics and other equipment. The Instruction Manual will refer to the T-REX 600XN Super Combo. You may purchase any additional items or spare parts referenced in the instruction manual.

T-REX 600XN 系列商品除標準配備會因您購買的商品版本而有些微不同，在組裝、設定上都是一致的，在此我們以 Super Combo 作為操作範例，您也可依照書面上的商品圖訊來增選其他選購商品。



| T-REX 600XN COMBO STANDARD EQUIPMENT | | | T-REX 600XN SUPER COMBO 標準配備 | | | [RH60N06XT] |
|---|---|--|---|---|--|-------------|
|  600NC5 |  600 Carbon Fiber Blades x 1set 600 碳纖維旋翼 |  600NH17 |  600NH18 |  600NB2 |  600NB10 | |
|  600NB11 |  600NB8 |  600NB13 |  600NB14 |  600NB15 |  700HG3 | |
|  60HT6A |  60NT9 |  600NT12 |  600NZ |  Beast Governor Sensor x 1 定速器感應器 x 1 |  B6M 2 In 1 Voltage Regulator x 1 二合一降壓器 x 1 | |
|  DS830M High Voltage Brushless Servo x 3 DS830M 高壓無刷伺服器 x 3 |  DS835M High Voltage Brushless Servo x 1 DS835M 高壓無刷伺服器 x 1 |  DS530 Digital Servo x 1 DS530 數位伺服器 x 1 |  ALIGN 55 Engine ALIGN 55引擎 |  50 Muffler 50 高效加速管 | | |

| T-REX 600XN COMBO STANDARD EQUIPMENT | | | T-REX 600XN COMBO 標準配備 | | | [RH60N07XT] |
|--|--|---|--|---|---|--|
|  600NC5 |  600 Carbon Fiber Blades x 1set 600 碳纖維旋翼 |  600NH17 |  600NH18 |  600NB2 |  600NB10 |  600NB11 |
|  600NB8 |  600NB13 |  600NB14 |  600NB15 |  700HG3 |  60HT6A |  60NT9 |
|  600NT12 |  600NZ |  Beast Governor Sensor x 1 定速器感應器 x 1 |  B6M 2 In 1 Voltage Regulator x 1 二合一降壓器 x 1 |  DS830M High Voltage Brushless Servo x 3 DS830M 高壓無刷伺服器 x 3 |  DS835M High Voltage Brushless Servo x 1 DS835M 高壓無刷伺服器 x 1 |  DS530 Digital Servo x 1 DS530 數位伺服器 x 1 |

CAREFULLY INSPECT BEFORE REAL FLIGHT 請嚴格執行飛行前之檢查義務

- Before flying, please check to make sure no one else is operating on the same frequency for the safety.
- Before flight, please check if the batteries of transmitter and receiver are enough for the flight.
- Before turn on the transmitter, please check if the throttle stick is in the lowest position. IDLE switch is OFF.
- When turn off the unit, please follow the power on/off procedure. Power ON- Please turn on the transmitter first, and then turn on receiver. Power OFF- Please turn off the receiver first and then turn off the transmitter. Improper procedure may cause out of control, so please to have this correct habit.
- Before operation, check every movement is smooth and directions are correct. Carefully inspect servos for interference and broken gear.
- Check for missing or loose screws and nuts. See if there is any cracked and incomplete assembly of parts. Carefully check main rotor blades and rotor holders. Broken and premature failures of parts possibly cause a dangerous situation.
- Check all ball links to avoid excess play and replace as needed. Failure to do so will result in poor flight stability.
- Check if the battery and power plug are fastened. Vibration and violent flight may cause the plug loose and result in out of control.

- 每次飛行前應先確認所使用的頻率是否會干擾他人，以確保自身與他人的安全。
- 每次飛行前請確定您發射器與接收器電池是在足夠飛行的狀態。
- 開機前請確認油门搖桿是否位於最低點，熄火降落開關，定速開關 (IDLE) 是否於關閉位置。
- 開機時必須遵守電源開關機器的程序，開機時應先開啟發射器後，再開啟接收器電源；關機時應先關閉接收器後，再關閉發射器電源。不正確的開關程序可能會造成失控的現象，影響自身與他人的安全，請養成正確的習慣。
- 開機前請先確定直昇機的各個動作是否順暢，及方向是否正確，並檢查伺服器的動作是否有干涉或磨損的情形，使用故障的伺服器將導致不可預期的危險。
- 飛行前請確認沒有缺少或鬆動的螺絲與螺帽，確認沒有組裝不完整或損毀的零件，仔細檢查主旋翼是否有損壞，特別是接近主旋翼座的部位。損壞或組裝不完整的零件不僅影響飛行，更會造成不可預期的危險。注意：每次飛行前的安全檢查、保養、及更換損耗零件，請確實嚴格執行以確保安全。
- 檢查所有的選擇頭是否有鬆脫的情形，過鬆的選擇頭應先更新，否則將造成直昇機無法操控的危險。
- 確認電池及電源接頭是否固定牢靠，飛行中的震動或激烈的飛行，可能造成電源接頭鬆脫而造成失控的危險。

When you see the marks as below, please use relative glue or grease to ensure flying safety.

標有以下符號之組裝步驟，請配合上膠或上油，以確保鎖附零件使用之可靠度。

- CA : Apply small amount of CA Glue to fix.

鎖附膠：使用適量鎖附膠固定

- R48 : Apply small amount of Anaerobic Retainer to fix.

鎖氣膠：使用適量鎖氣膠固定

- T43 : Apply small amount of Thread Lock to fix.

螺絲膠：使用適量螺絲膠

- OIL : Add small amount of OIL.

潤滑油：添加適量潤滑油

- Grease : Add small amount of Grease.

潤滑油：添加適量潤滑油

When assembling ball links, make sure the "A" character faces outside.

各項塑膠製連桿頭扣接時，"A"字請朝外。



Keep plastic parts away from heat.

塑膠零件避免靠近熱源。



CA Glue
鎖附膠



Anaerobic Retainer
鎖氣膠



Thread Lock
螺絲膠



Grease
潤滑油



OIL
潤滑油

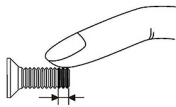

T43 Glue width : approx. 1mm
T43 上膠寬度約 1mm

1. Anaerobic Retainer (R48) is green penetrating threadlocker and is used to fix the metal tube before assembly at temperatures up to +180°C.
2. Thread Lock(T43) is blue low strength threadlocker and is applied to the small screw(threads) or metal parts before assembly to prevent loosening. Ensure to apply only a small amount and wipe surplus off. When disassembling, recommend to heat the metal joint about 15 Seconds.
3. Grease is kind of lubricant additive which is applied to the one-way bearings or thrust bearing.

Based on parts physical attributes, please apply small amount of the relative glue or grease accordingly to prevent any parts damage or loosening or unexpected danger happened.

1. 鎖氣膠 (R48) 為綠色高強度快速固化的鎖氣膠，適合於金屬管狀固定用，可耐高溫至 180°C。
2. 螺絲膠 (T43) 為藍色低強度螺絲膠，適合小型螺絲；使用於金屬內外件或膠合螺絲時，請務必適量使用，必要時請用手去除多餘膠量，欲拆卸時可於金屬接合部位加熱約 15 秒。
3. 潤滑油 (Grease) 為膏狀潤滑油，適用於單向軸承或止推軸承。

以上各類功能膠(油)請依零件屬性需求自行準確量取附其用量，以達到最佳組裝狀態，避免因使用不當造成零件損壞或不可預期的意外發生。

600NH17



Bearing
軸承(φ8xφ14x4mm) x 4



Socket Collar Screw
圓頭內六角軸套螺絲(M3x6mm)X4

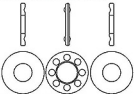

Thrust Bearing
止推軸承(φ8xφ14x4.5mm) x 2



Spindle Bearing Spacer
鎖軸軸承墊片(φ10xφ13.8x0.4mm) x 2



Thrust bearing and washer for radial bearing are wear items; therefore, it is recommended to inspect after every 20 flights and replaced as necessary. For flights with high headspeed, the inspection interval should be reduced to ensure flight safety.

止推軸承及橫軸軸承屬於飛行消耗品，建議每20趟定期檢查及更換，高主旋翼轉速飛行時，請縮短定期檢查之週數，以確保飛行安全。

Apply a small amount of T43 thread lock when fixing a metal part.
螺絲鎖附於金屬件時使用適量T43(螺絲膠)。



Original manufacturer packages contains product already assembled, please confirm every screw is firmly secured with T43. Do not use T43 on any plastic part.

原裝零件出廠包裝如果是組裝品，請需再確認各螺絲是否鎖緊上膠。請注意T43不可塗在任何的塑膠材質上。

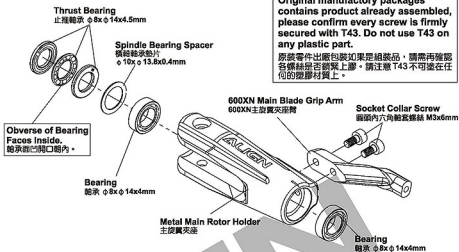

Apply Grease on Thrust Bearing.
止推軸承塗上潤滑油

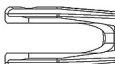
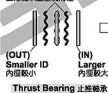

600NH17



Feathering Shaft Sleeve
橫軸支撐套(φ8xφ10x31mm) x 1



Damper Rubber
橫軸墊圈(φ8xφ12.9x6.5mm) x 2



Spacer
橫軸墊圈(φ8xφ11x1.3mm) x 2



Socket Screw
圓頭內六角螺絲(M5x10mm)x2



Washer
橫軸墊圈(φ8xφ12x1mm)x2

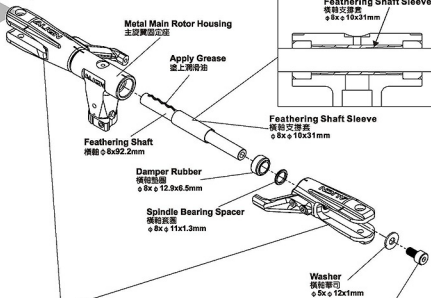

ALIGN Logo on The Top
字樣朝上

600NH17



Bearing
軸承(φ3xφ7x3mm) x 4



Washer
華司(φ3xφ4.8x0.3mm) x 2



Socket Screw
圓頭內六角螺絲(M2x5mm) x 4



Bearing
軸承(φ2xφ5x2.3mm) x 4



Collar
摺彎軸承襯套(φ3xφ4.8x1.5mm) x 2



Socket Screw
圓頭內六角螺絲(M3x12mm) x 2

Apply a small amount of T43 thread lock when fixing a metal part.
螺絲鎖附於金屬件請使用適量 T-43 (螺絲膠)。

600NH18



700N Linkage Ball B (M3x4)
700N 球頭 B(M3x4)(φ5x12mm) x 6



Long Linkage Ball (M3x4)
導板長球頭(M3x4)(φ5x28mm) x 1

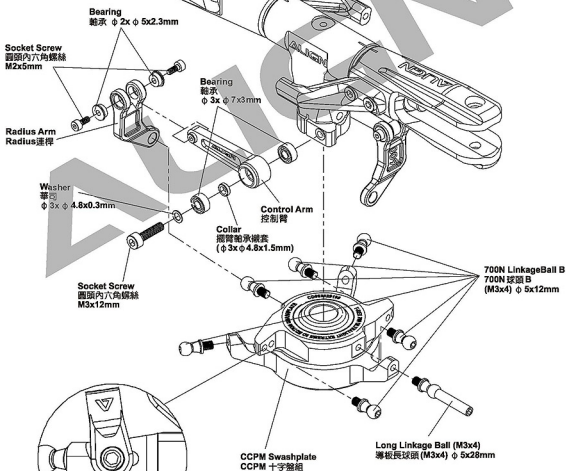

600NH17A



Already assembled by Factory. Before flying, please check if the screws are fixed with glue.
廠裝組裝完成品，每一次飛行前請先確認螺絲是否已上膠不會鬆動。

Apply a small amount of T43 thread lock when fixing a metal part.
螺絲鎖附於金屬件請使用適量T43(鎖絲膠)。



Linkage Rod(A)
連桿 A (M3x35mm) x 2



Linkage Ball B(M3x4)
球頭 B(M3x4)(ϕ 5x10.5mm) x 2



Socket Collar Screw
圓頭內六角鉸緊螺絲 (M3x19mm) x 2



M3 Nut
M3 防鬆螺帽 x 2



Collar
連桿套 x 4



Elevator Ball Link
升降桿連桿套 x 4

Linkage Ball B (M3x4)
球頭 B(M3x4)
 ϕ 5x10.5mm

Elevator Ball Link
升降桿連桿套

Linkage Rod(A)
連桿 A M3x35mm

Collar
連桿套

Socket Collar Screw
圓頭內六角鉸緊螺絲
M3x19mm

M3 Nut
M3 防鬆螺帽

Socket Collar Screw
圓頭內六角鉸緊螺絲
M3x19mm

600XN Main Rotor Holder Arm
Linkage Rod(A)
Approx. 53mm x 2
600XN 主旋翼夾座臂
連桿 (A) 約 53mm x 2

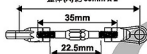

Main Shaft
主軸 ϕ 6x ϕ 10x188.3mm



For installation, make sure the "Check Point" is face upward, then use plier or wrench grasp the center of hexagonal rod to adjust its suitable length, turns clockwise to decrease the length, turns counter clockwise to increase the linkage length.

組裝時請將連桿中間溝槽辨識標頭上，請使用尖嘴鉗或扳手調整連桿中間六角柱部位調整適當長度，同時針轉動為縮短連桿長度；逆轉針轉動則為調長連桿長度。

Left-hand
逆轉

Check Point
溝槽辨識

Right-hand
正轉



You may adjust the length of ball link when tracking is off while in flight.

若飛行中有變態情形，可適當調整連桿頭長短改善。

MAIN ROTOR GRIP ARM AND LINKAGE ROD

SYMMETRICAL PITCH, THE BEST PRECISION

動作對稱距離，精準度更好

Main Rotor Grip Arm and Linkage Rod is at 90-degree angle symmetrically, allow to keep the best precise flight performance.

主旋翼連桿與夾座臂 90度設計，使螺距動作成對稱比例，讓直昇機動作更精準無誤差。

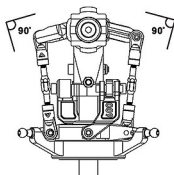

600NB8

Hex Socket Self Tapping Screw
 六角內六角白攻螺絲(T3x7mm)x5



One-way Bearing
 單向軸承(φ12xφ18x16mm)x1



Washer
 單向軸承墊圈(φ11.5xφ18x0.8mm)x1



One-way Bearing Shaft
 單向軸承套(φ9xφ12x34.7mm)x1



Bearing
 軸承(φ12xφ18x4mm) X 1

One-way Bearing Shaft

單向軸承套
 φ9xφ12x34.7mm



Apply Grease
 塗上黃牛油

Bearing

軸承 φ12xφ18x4mm

Hex Socket Self Tapping Screw
 六角內六角白攻螺絲
 T3x7mm

One-way Bearing
 單向軸承
 φ12xφ18x16mm

Already assembled by factory,
 please note to check again.
 已組裝完成，請務必自行再確認。

Main Gear Case
 主齒中心殼

Main Drive Gear
 主齒輪
 170T

Autrotation Tail Drive Gear
 尾驅動主齒
 180T

Washer
 單向軸承墊圈
 φ11.5xφ18x0.8mm

Apply a small amount of T43 thread lock when fixing a metal part.
 螺絲鎖附於金屬件時請使用適量T43(螺絲膠)。

Before tightening the screw, please rotate the bearing and check the concentricity of the bearing in order to have the screw firmly secured, to avoid the bearing stuck or heavy load at one side and cause slip.
 上緊螺絲前請旋轉軸承並檢查同心度是否良好，才能將螺絲平均鎖緊，以避免造成卡死或單向重負載可能產生的打滑。

600NB14A

Socket Screw
 圓頭內六角螺絲(M3x12mm) x 2



M3 Nut
 M3 防鬆螺帽 x 2

700X Hex Mounting Bolt
 700X 六角鉚柱
 M3X36mm

Socket Screw
 圓頭內六角螺絲
 M3x12mm

Starter Coupling
 六角啟動套
 φ5xφ10x18mm

Bearing
 軸承
 φ5xφ13x4mm

Clutch Nut
 聯合齒輪螺帽
 φ14x6mm

Bearing
 軸承 φ5xφ13x4mm

600XN Idler Pulley Gear 26T
 600XN 惰輪齒 26T

600NB15

M4 Set Screw
 M4 止鎖螺絲(M4x4mm) x 2



Bearing
 軸承(φ5xφ13x4mm) x 1



Clutch Nut
 聯合齒輪螺帽(φ14x6mm) x 1



600XN Idler Pulley Gear 18T
 600XN 惰輪齒 18T

Bearing
 軸承 φ5xφ13x4mm

Bearing
 軸承 φ10xφ15x4mm

600XN Clutch Gear
 600XN 聯合齒輪 20T

Governor Sensor
 定速感應磁鐵

Clutch Bell
 聯合齒輪
 φ44.4xφ47x20mm

Bearing
 軸承
 φ5xφ13x4mm

Clutch L liner
 600XN 聯合齒輪
 φ42.4xφ44.4x3mm

Clutch/Start Shaft
 啟動軸
 φ7.5xφ10x68.4mm

600NB14

Bearing
 軸承(φ10xφ15x4mm) x1



Bearing
 軸承(φ5xφ13x4mm) x5



CAUTION
 注意

Original manufactory packages contains product already assembled, please confirm every screw is firmly secured with T43. Do not use T43 on any plastic part.

原裝零件出廠包裝如果是組裝品，請務必確認各螺絲是否都緊上膠。請注意 T43 不可塗在任何的塑膠材質上。

CAUTION
 注意

Make sure to inspect gears after every flight. Clean the Idler Pulley and Clutch Bell Helical Gear surface if necessary and suggest to apply some moly grease every five rounds to ensure working efficiency and keep durability.

每次飛行後請實地視齒輪狀況，必要時請清潔齒輪與聯合齒輪齒面，建議每五圈飛行後重新塗抹二硫化鉬潤滑油，以確保齒輪傳動效率與使用壽命。

Already assembled by factory,
 please note to check again.
 已組裝完成，請務必自行再確認。

Apply a small amount of T43 thread lock when fixing a metal part.
 螺絲鎖附於金屬件請使用透層T43(螺絲鎖)。



Original manufactory packages contains product already assembled, please confirm every screw is firmly secured with T43. Do not use T43 on any plastic part.

原裝零件出廠包裝如果是組裝品，請再確認各螺絲是否鎖緊上膠。請注意 T43 不可塗在任何的塑膠材質上。

To ensure proper sensor detection of rotating speed, adjust the speed governor sensor so that it is approximately 1mm from magnet.

調整定速感知器高度，使感知器與磁鐵距離約 1mm，以確保感知器正確的偵測轉速。

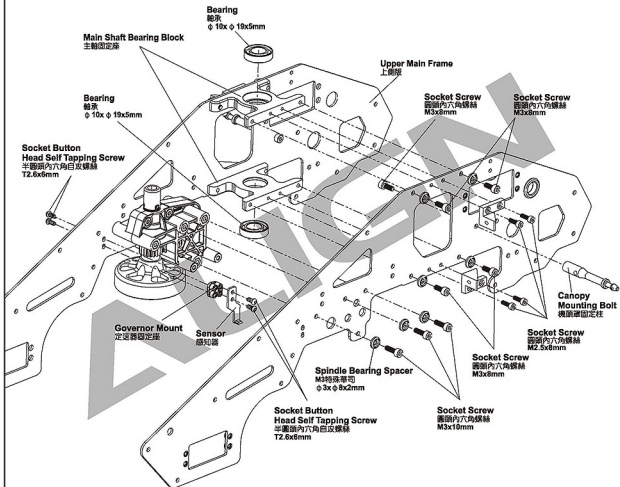
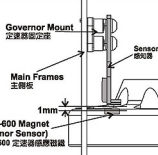

600NB13A



600NB13A



600NB14A



600NB11



600NB13



Socket Button Head Self Tapping Screw
半圓頭內六角自攻螺絲 (T3x6mm) x2

Apply a small amount of T43 thread
lock when fixing a metal part.
鎖絲鎖附於金屬件處使用適量T43(螺絲膠)。

CAUTION
注意

Original manufactory packages
contains product already assembled,
please confirm every screw is firmly
secured with T43. Do not use T43 on
any plastic part.

原廠零件出廠包裝如果是組裝品，請帶再確認
各樣螺絲是否鎖緊上膠。請注意T43不可塗在任
何的塑膠材質上。

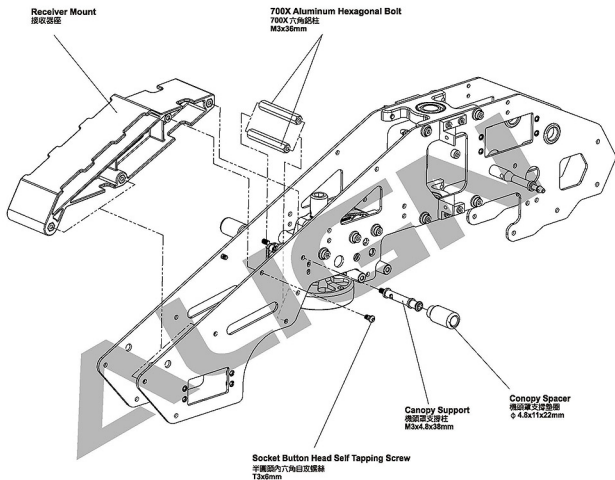

Apply a small amount of T43 thread lock when fixing a metal part.
 鎖絲旋於金屬件時使用適量T43(螺絲膠)。

CAUTION
 注意

Original manufactory packages contains product already assembled, please confirm every screw is firmly secured with T43. Do not use T43 on any plastic part.

原裝零件出廠包裝如果是組裝品，請再確認各螺絲是否鎖緊上膠。請注意T43不可塗在任何的塑膠材質上。

600NB14A



M3 Specialty Washer
 M3 特殊華司 (φ 3x φ 8x2mm) x 2



Socket Screw
 圓頭內六角螺絲 (M3x10mm) x 4

600NB12



Socket Screw
 圓頭內六角螺絲 (M3x12mm) x 4



M3 Washer
 M3 華司 (φ 3x φ 8x1mm) x 4

600NB15



Socket Screw
 圓頭內六角螺絲 (M3x12mm) x 2



Socket Button Head Screw
 半圓頭內六角螺絲 (M4x5mm) x 2



Socket Head Spring Screw
 圓頭內六角彈簧螺絲 (M4x8mm) x 2



Socket Button Head Screw
 半圓頭內六角螺絲 (M3x5mm) x 2

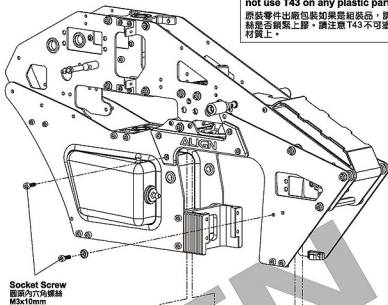

Socket Screw
 圓頭內六角螺絲
 M3x10mm



Socket Screw
 圓頭內六角螺絲
 M3x12mm

M3 Washer
 M3 華司 φ 3x φ 8x1mm

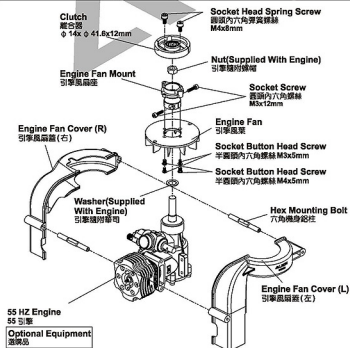

Clutch
 離合器
 φ 14x φ 41.6x12mm

Engine Fan Mount
 引擎風扇座

Engine Fan Cover (R)
 引擎風扇蓋 (右)

Washer (Supplied With Engine)
 引擎附帶華司

55 HZ Engine
 55 引擎

Optional Equipment
 選購品

Socket Head Spring Screw
 圓頭內六角彈簧螺絲
 M4x8mm

Nut (Supplied With Engine)
 引擎附帶螺帽

Socket Screw
 圓頭內六角螺絲
 M3x12mm

Engine Fan
 引擎風扇

Socket Button Head Screw
 半圓頭內六角螺絲 M3x5mm

Socket Button Head Screw
 半圓頭內六角螺絲 M4x5mm

Hex Mounting Bolt
 六角機身螺栓

Engine Fan Cover (L)
 引擎風扇蓋 (左)

Clutch
 離合器
 φ 14x φ 41.6x12mm

Socket Screw
 圓頭內六角螺絲
 M3x12mm

55 HZ Engine
 55 引擎

Optional Equipment
 選購品

Engine Fan
 引擎風扇

Engine Fan Mount
 引擎風扇座

After install the engine into the model, please loosen the fixing screw and adjust the carburetor and the engine are at an angle of 90° (Vertical).

引擎裝入機體後請鬆開固定螺絲將化油器調成與引擎垂直。



Main frame assembly point :

First do not fully tighten the screws of main frames and put two bearings through the main shaft to check if the movements are smooth. The bottom bracket must be firmly touched the level table top(glass surface); please keep the smooth movements on main shaft and level bottom bracket, then slowly tighten the screws. This assembly can improve power and flight performance.

機身側板組立要點：

側板螺絲先不完全鎖緊，放入主軸貫穿二顆軸承確認上下移動必需滑順，主體底框必須與水平桌面(玻璃平面)踏實緊貼；請保持主軸滑順與底框平行桌面後慢慢鎖緊螺絲，正確側板的組裝對動力與飛行性能有顯著幫助。

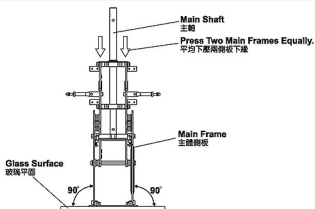

600NB12



700NG1



Apply a small amount of T43 thread lock when fixing a metal part.
螺絲鎖附於金屬件請使用適量 T43 (螺絲膠)。



Original manufacturer packages contains product already assembled, please confirm every screw is firmly secured with T43. Do not use T43 on any plastic part.

原廠零件出廠包裝如果是組裝品，請再確認各螺絲是否鎖緊上膠。請注意 T43 不可塗在任何的塑膠材質上。

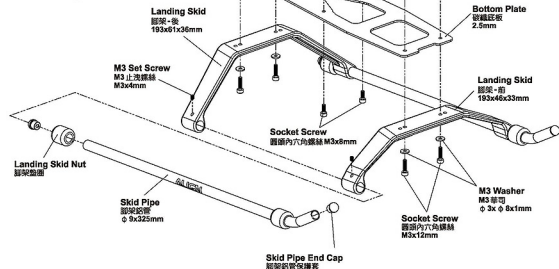

600NZ12



Original manufacturer packages contain product already assembled, please confirm every screw is firmly secured with T43. Do not use T43 on any plastic part.

原廠零件出廠包裝如果是組裝品，請再確認各螺絲是否鎖緊上膠。請注意 T43 不可塗在任何的塑膠材質上。

Apply a small amount of T43 thread lock when fixing a metal part.
螺絲鎖附於金屬件請使用適量 T43 (螺絲膠)。

Linkage Ball C(M2.5x4)
球頭 C(M2.5x4) (φ 5x12mm) x 3

Socket Button Head Screw
半圓頭內六角螺絲 (M2.5x10mm) x 6

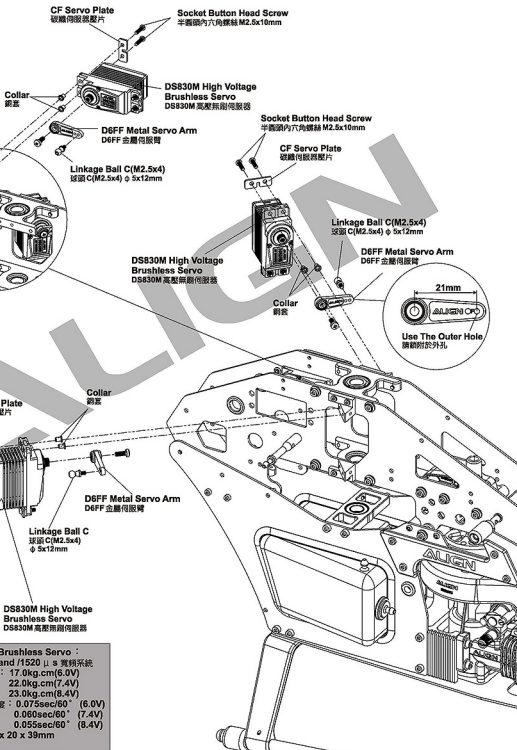

DS830M High Voltage Brushless Servo :
 1. 1520 μs Standard Band / 1520 μs 寬頻系統
 2. Stall Torque/ 輸出扭力 : 17.0kg.cm(6.0V)
 22.0kg.cm(7.4V)
 23.0kg.cm(8.4V)
 3. Motion Speed/ 動作速度 : 0.075sec/60° (6.0V)
 0.060sec/60° (7.4V)
 0.055sec/60° (8.4V)
 4. Dimension/ 尺寸 : 40 x 20 x 39mm
 5. Weight/ 重量 : 80g

Recommend sanding the marked position as below illustration with a waterproof abrasive paper(#800-1000) to avoid the wires of electric parts to be cut.

建議於下圖色塊標示處，使用#800-1000水砂紙打磨，可防止電子設備電線被刮破。

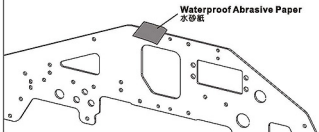

600NZ12

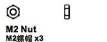

600NZ10



600NB12



Apply a small amount of T43 thread lock when fixing a metal part.
鎖絲膠用於金屬件固定時塗量T43 (鎖絲膠)。

- DS530 Digital Servo :**
 1. 1.1520 μ s Standard Band / 1520 μ s 寬頻系統
 2. Stall Torque/輸出扭力 : 6.5kg.cm(6.0V)
 9.0kg.cm(8.4V)
 3. Motion Speed/動作速度 : 0.085sec/60° (6.0V)
 0.065sec/60° (8.4V)
 4. Dimension/尺寸 : 35.1 x 15.1 x 29mm
 5. Weight/重量 : 29g



Original manufacturer packages contains product already assembled, please confirm every screw is firmly secured with T43. Do not use T43 on any plastic part.
 原裝零件出廠包裝如果是組裝品，請再確認各螺絲是否裝緊上膠，請注意 T43 不可塗在任何的塑膠材質上。

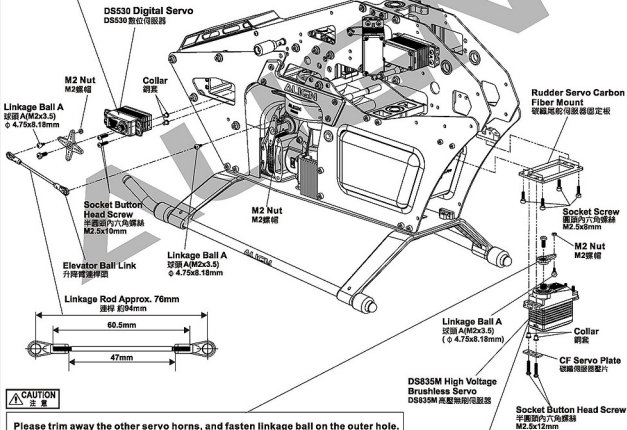

Please trim away the other servo horns, and fasten linkage ball on the outer hole.
 請先將原附十字舵角片切除多餘的另三邊，並將球頭鎖附於最外孔。

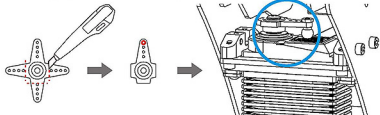

- DS835M High Voltage Brushless Servo :**
 1. 1.1520 μ s Standard Band / 1520 μ s 寬頻系統
 2. Stall Torque/輸出扭力 : 8.0kg.cm(6.0V)
 10.0kg.cm(7.4V)
 12.5kg.cm(8.4V)
 3. Motion Speed/動作速度 : 0.04sec/60° (6.0V)
 0.03sec/60° (7.4V)
 0.028sec/60° (8.4V)
 4. Dimension/尺寸 : 40 x 20 x 391mm
 5. Weight/重量 : 72g

Apply a small amount of T43 thread lock when fixing a metal part.
 鎖緊固定金屬件時使用適量 T43 (鎖絲膠)。

CAUTION
 注意

Original manufactory packages contains product already assembled, please confirm every screw is firmly secured with T43. Do not use T43 on any plastic part.

原裝零件出廠包裝如果是組裝品，請務必確認各螺絲是否鎖緊上膠。請注意 T43 不可塗在任何的塑膠材質上。

FAN COVER FIXING TIP
 風扇罩固定螺絲

Before fixing the engine fan cover, please use a starter to rotate the fan and move the fan cover. This is to make sure there is no interference, and then secure the fan cover with a fixing screw.

鎖緊固定引擎散熱風罩前，請先使用啟動棒轉動風扇，並移動風扇罩，確認在風扇無接觸風罩後才鎖緊風扇罩固定螺絲。

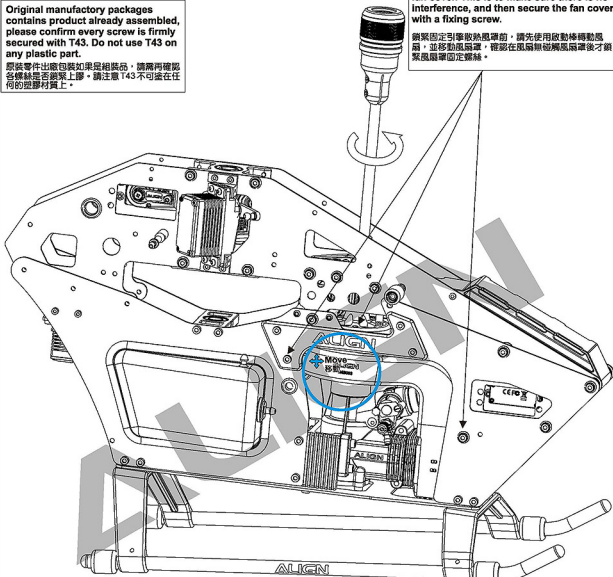

CAUTION
 注意

For engine adjustment and precautions, please refer to the factory manual for more instruction.
 引擎各項調整及注意事項，請參照原廠使用說明書。

FUEL TUBE CLIP B ILLUSTRATION 油管夾片 B 使用說明

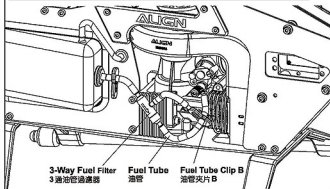

3-Way Fuel Filter 3 油路過濾網
 Fuel Tube 油管
 Fuel Tube Clip B 油管夾片 B

FUEL TUBE CLIP ILLUSTRATION 油管夾片使用方法

Engine Start :
 Unlock to refuel.
 引擎啟動：鎖啟油料供給

Engine Stop :
 Lock to stop refueling.
 引擎熄火：鎖閉油料供給

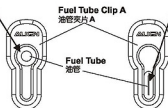

Fuel Tube Clip A 油管夾片 A
 Fuel Tube 油管

600NT9

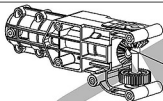
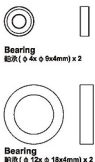
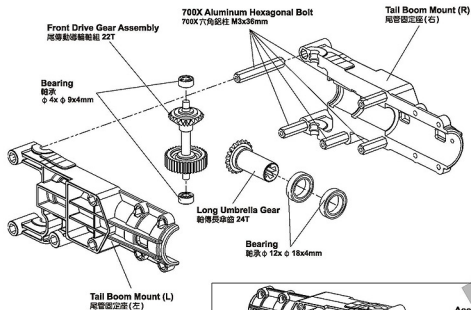

Assembling Umbrella Gear :
Please note to push the gear to the end at a fixed position, to make sure the gears mesh with each other smoothly.
傘齒組裝：注意務必將推到位，以免齒咬合不順暢。

600NT10

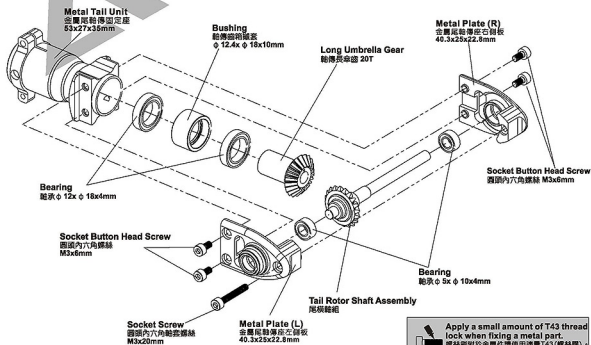

Apply a small amount of T43 thread lock when fixing a metal part.
螺絲鎖附於金屬件請使用適量 T43 (螺絲鎖)。

60NT10

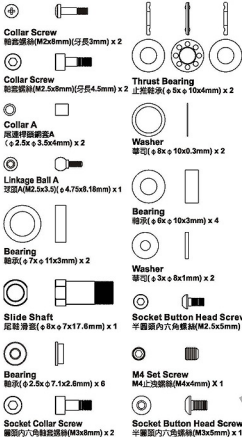

CAUTION 注意

Original manufactory packages contains product already assembled, please confirm every screw is firmly secured with T43. Do not use T43 on any plastic part. 原裝零件包裝包裝如果是組裝品，請確認每顆螺絲是否緊繫上膠。請勿在T43上任何塑膠零件。

60HT6A



CAUTION 注意

The Metal Tail Rotor Holder is assembled at the factory, make sure to apply little thread lock on screws and tighten them back appropriately before starting to fly. Suggest to use torque wrench or torque lock for tightening screws with the torque value 5.0kg.cm.

尾槳夾座出廠為預組裝，螺絲必須在出廠前塗抹適量潤滑油，請務必在飛行前重新鎖緊。若需注意潤滑油後即可，建議請使用扭力或扭力鎖鎖緊，扭力值為5.0kg.cm。

THRUST BEARING 止推軸承

Apply Grease on Thrust Bearing. 止推軸承塗上潤滑油

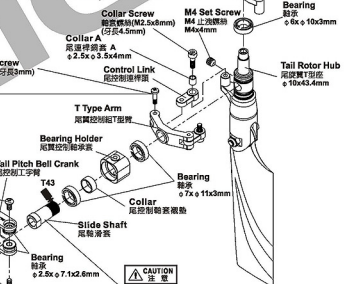

Apply a small amount of T43 thread lock when fixing a metal part. 鎖套螺絲於金屬零件處使用適量T43(螺絲鎖)。

CAUTION 注意

Please tighten M2x8 mmi collar screw firmly but not over tightened. Over tighten the screw will cause the operation of control link to be tight. 請將M2x8mm軸套螺絲緊密用適量力鎖，過度鎖緊會造成尾槳控制連桿轉動不順。

Assembling Umbrella Gear: Please note to push the gear to the end at a fixed position, to make sure the gears mesh with each other smoothly. 傘齒組裝：注意務必將齒推到固定位置，以避免齒咬合不順暢。

CAUTION 注意

Aim tail rotor hub at the concave of the tail rotor shaft and apply thread lock on the set screw. The tail rotor hub and screws are wear items, and thus should be inspected for replacement after every 100 flights. For flights with high head speed, the inspection period should be reduced to ensure flight safety.

尾槳實T型座與尾槳桿螺絲的咬合前，請確認尾槳螺絲上膠。尾槳實T型座和螺絲屬於飛行消耗品，建議每100次飛行檢查更換。高主旋翼轉速飛行時，請縮短定期檢查之週數，以確保飛行安全。

CAUTION 注意

While assembly the slide shaft, please use suitable amount of T43 on the shaft. Please do not use R48 or other high strength thread lock to avoid damages while maintenance or repairs.

組裝尾槳滑套時，請使用適量的T43螺絲鎖在螺絲上，嚴禁使用R48高強度鎖套螺絲防止膠合過緊，以避免日後拆裝螺絲零件之損傷。

CAUTION 注意

After complete the tail rotor assembly, please check if it rotates smoothly. 尾槳實螺絲鎖裝完後務必確認尾槳夾座轉動順暢。

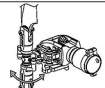

Already assembled by factory, please note to check again.
已組裝完成，請務必再行確認。

Socket Screw
圓頭內六角螺絲
M3x10mm

When assembling into the tail boom, please apply some oil on the surface, to make it smooth during the assembling and keep it vertical with the torque tube for smooth rotation.

插入尾管內時，外表抹些潤滑油，以確保平滑插入尾管中並與尾管軸保持垂直，讓尾管轉動順暢。

When assembling the tail boom, please aim at the fixing hole $\phi 5.1$.
裝入尾管時請注意孔對準尾管 $\phi 5.1$ 固定孔。

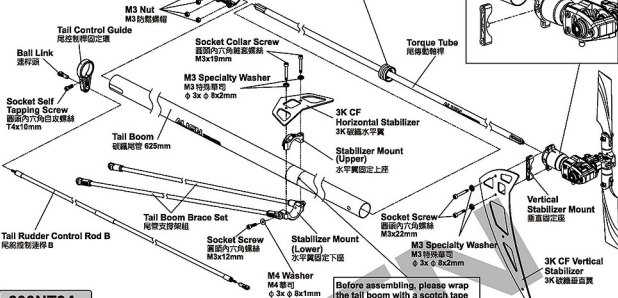

600NT9A

Socket Screw
圓頭內六角螺絲 (M3x10mm) x 4

M3 Nut
M3 防鬆螺帽 x 4

600NT11A

Socket Screw
圓頭內六角螺絲 (M3x12mm) x 2

M3 Washer
M3 華司 ($\phi 3x \phi 8x1mm$) x 2

Socket Collar Screw
圓頭內六角鍍藍螺絲 (M3x19mm) x 2

M3 Specialty Washer
M3 特殊華司 ($\phi 3x \phi 8x2mm$) x 2

600NT10

Socket Collar Screw
圓頭內六角鍍藍螺絲 (M3x22mm) x 2

M3 Specialty Washer
M3 特殊華司 ($\phi 3x \phi 8x2mm$) x 2

TIP TO FIX THE TORQUE TUBE 轉動軸承固定位置要領

Please apply some CA glue to fix bearing on the torque tube, avoid CA glue from the bearing side or may cause the bearing stuck. When assembling into the tail boom, please apply some oil and use the attached torque tube mount helper to press the bearing holder of the torque tube into the tail boom horizontally. 請以少量 CA 補漆膠固定於轉動軸上，避免 CA 補漆膠塗於轉動軸兩側導致軸卡死，插入尾管內時，尾管軸承座應向外抹些潤滑油，利用轉動軸承安裝套將轉動軸承座面平行壓入尾管中不可歪斜。

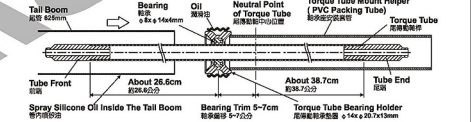

CAUTION 注意

Skewed torque tube bearing holder will interfere with torque tube rotation and cause unusual vibration.

尾管軸承座安裝歪斜會造成轉動軸運轉不順及尾管異常震動等問題。

60HT5A

Socket Self Tapping Screw
圓頭內六角白皮螺絲 T4x10mm X2

Ball Link
連桿組 X2

CAUTION 注意

After moving the tail control rod adjustment sleeve to recommended position, glue the sleeve to carbon tail control rod with instant glue.

尾管控制桿調整環調整至建議位置後，再將尾管控制桿調整環與碳纖維尾管控制桿表面以瞬間膠固定。

600NB11**600NT9A**

Apply a small amount of T43 thread lock when fixing a metal part.
螺絲鎖附於金屬件請使用適量 T43 (螺絲膠)。

CAUTION
注意

Original manufactory packages contains product already assembled, please confirm every screw is firmly secured with T43. Do not use T43 on any plastic part.

原裝零件出廠包裝如果是組裝品，請需再確認各螺絲是否鎖緊上膠，請注意 T43 不可塗在任何的塑膠材質上。

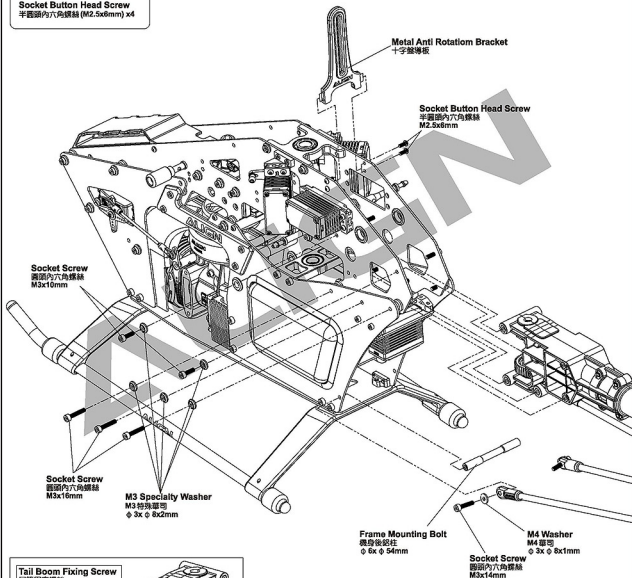

Tail Boom Fixing Screw
尾管固定螺絲

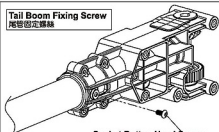

Socket Button Head Screw
半圓頭內六角螺絲 M3x6mm

CAUTION
注意

When tightening a screw to a plastic part, please tighten it firmly, but not over tightened, or they will strip.

螺絲鎖入塑膠件務必注意，適密扭力鎖緊即可，而過緊的扭力可能會導致滑牙。

600NH17A

Main Blade Fixing Screw

鎖主旋翼用螺絲



Socket Collar Screw
鎖副內六角軸套螺絲 (M4x25mm) x 2

M4 Nut
M4 防鬆螺帽 x 2

When tightening the main blade fixing screw, please tighten it firmly, but not over tighten, or it may cause the damage of main blade holder and result in danger.
鎖緊主旋翼螺絲須注意適當緊度即可，過緊可能導致主旋翼夾座受損，飛行意外發生。

600NZ10



Elevator Ball Link
升降桿連桿 x 6



Collar
滾桿套
(ϕ 6x ϕ 4.85x3mm) x 6



700X Linkage Rod(A)
700X 連桿 A (M3x41mm) x 3

600NH18



Main Shaft Spacer(0.5)
主軸墊片(0.5)
(ϕ 10.1x ϕ 14x0.5mm) x 1



Main Shaft Spacer(0.3)
主軸墊片(0.3)
(ϕ 10.1x ϕ 14x0.3mm) x 1

Standard Equipment :
Main Shaft Spacer(0.5)
主軸墊片(0.5)
Main Shaft Spacer(0.3)
主軸墊片(0.3)
標準品 : 主軸墊片(0.5)
主軸墊片(0.3)
 ϕ 10.1x ϕ 14x0.5mm
 ϕ 10.1x ϕ 14x0.3mm

Socket Collar Screw
鎖副內六角軸套螺絲
M4x25mm

600 Carbon Fiber Blades
600 碳纖維主旋翼

M4 Nut
M4 防鬆螺帽

700X Linkage Rod(A)
Approx. 59.5mm x 2
700X 連桿 (A) 約 59.5mm x 2

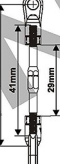

Main Drive Gear Set
鎖主齒輪(170T)

Socket Screw
鎖副內六角軸套螺絲
M3x20mm

M3 Nut
M3 防鬆螺帽

600NB8

M3 Nut
M3 防鬆螺帽 x 1

Socket Collar Screw
鎖副內六角軸套螺絲 (M3x20mm) x 1

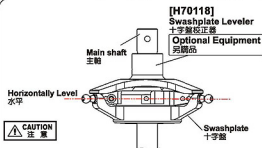

[H70118]
Swashplate Leveler
Optional Equipment
另購品

While using Flybarless system, please use the swashplate leveler to calibrate swashplate. Adjust the length of servo linkage rod to make sure the swashplate is leveled before start setting up to ensure the gyro provides the best performance.

使用無平衡系統，請務必使用十字盤調整器校正十字盤，調整伺服器連桿長度，確保十字盤達到水平狀態，再進行基本機體設定，這樣才能確保飛行性能達到最佳效果。

Apply a small amount of T43 thread lock when fixing a metal part.
螺絲鎖附於金屬件請使用適量T43(螺絲膠)。



Apply a small amount of T43 thread lock when fixing a metal part.
螺絲鎖附於金屬件時請使用適量T43(螺絲膠)。



Original manufacturer packages contains product already assembled, please confirm every screw is firmly secured with T43. Do not use T43 on any plastic part.

原裝零件出廠包裝如果是組裝品，請需再確認各螺絲是否鎖緊上膠。請注意 T43 不可塗在任何的塑膠材質上。

A MOUNTING ORIENTATION OF MICROBEAST PLUS MICROBEAST PLUS的安裝方向



Please visit Align download area to get the completed instruction manual at Align website.

更多詳細的設定操作說明請至官網下載專區下載。
<http://www.align.com.tw/beastx/>

Microbeast PLUS provides 8 different direction choices can be installed on any position of helicopter.

Microbeast PLUS 提供8種不同方向選擇，可以安裝在機體的任何一個位置。

THE COLOR OF THE STATUS-LED SHOWS THE CURRENTLY SELECTED ORIENTATION:

LED指示燈狀態顯示安裝方向：



Status LED Off*
Status-LED 燈熄滅*



Status LED Flashing Purple
Status-LED 燈
紫色閃爍



Status LED Purple
Status-LED 燈紫色



Status LED Flashing Red
Status-LED 燈
紅色閃爍



Status LED Red
Status-LED 燈紅色



Status LED Flashing Blue
Status-LED 燈
藍色閃爍



Status LED Blue
Status-LED 燈藍色



Status LED Flashing Red/Blue
Status-LED 燈
紅色藍色閃爍

Front
機頭方向

* Factory Setting

* 出廠預設值

Optional Equipment
選購品
Battery of Receiver
接收器電池

Optional Choice : 2S1P 7.4V
Li-Po 1900~2600mAh Battery
可選用：2S1P 7.4V Li-Po
1900~2600mAh 電池

Hook and Loop Tape(Fuzzy)
魔術沾(絨毛狀)

Hook and Loop Tape(Hooked)
魔術沾(勾狀)

Receiver Mount
接收器座

Muffler
加速管

Optional Equipment
選購品

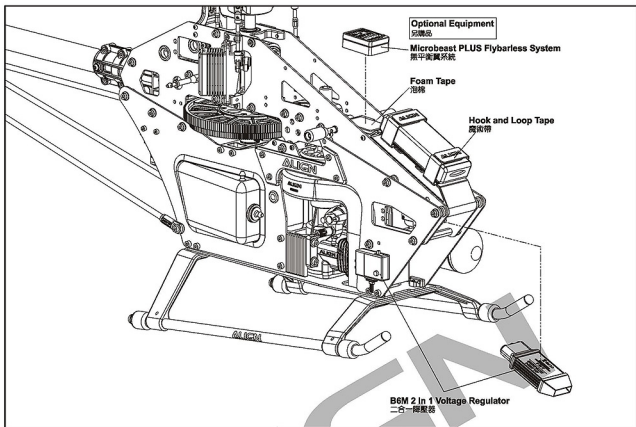

CANOPY ASSEMBLY

機頭罩安裝

ALIGN

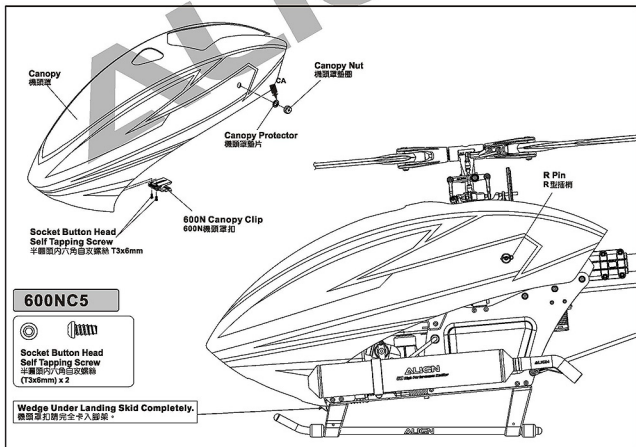

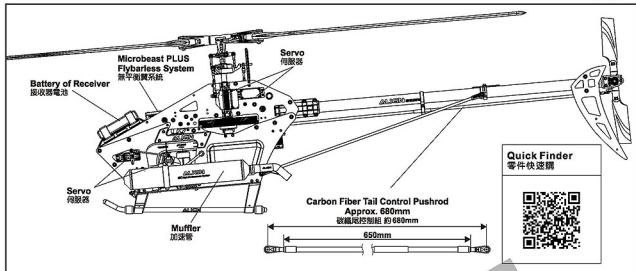

MICROBEAST PLUS FLYBARLESS MANUAL

無平衡翼系統使用說明

ALIGN

MICROBEAST PLUS Flybarless System as ALIGN helicopter standard equipment, must and compatible with ALIGN standard equipment including blades, servos, motor, battery and so on, please refer to flight and setup instruction in this manual.

ALIGN 直昇機使用 MICROBEAST PLUS 無平衡翼系統，須搭配 ALIGN 直昇機標準配件(主旋翼、伺服器、馬達)與飛行操作、設定指示。

USER NOTICE 使用注意事項



1. If assembling and operating the helicopter without using ALIGN standard equipment, including electronic equipment & blades...etc, please make sure there is a sufficiently large and stable power supply to your helicopter. If there is any abnormal voltage or insufficient power supply, suggest to upgrade the flybarless system to MICROBEAST PLUS HD (Optional) for better power back up.
2. Please refer to BEASTX MICROBEAST PLUS/HD website for MICROBEAST PLUS/HD assembly and setup instruction.
3. Any over use, incorrect setup, missassembly, incorrect modification or misuse will lead to abnormal voltage, electronic devices damage, structural interference, and insufficient power supply. Make sure to carefully check every assembly and setup refer to the manual instruction prior to every flight to prevent any unforeseen danger.

1. 安裝、操控您的直昇機時，如非使用 ALIGN 標準配件(含電子配件、主旋翼等)，請務必確定您的供電系統有足夠的供電能力，如發現電壓異常、供電不足，建議您升級使用 MICROBEAST PLUS HD 無平衡翼系統(選配)，以能確保充足、穩定的接收器電壓。
2. MICROBEAST PLUS/HD 使用、設定、接線，請參照 BEASTX MICROBEAST PLUS/HD 官方說明。
3. 任何電子配件、零件的設定、組裝、修改或操作不良所造成的電壓異常、電子零件損壞，即可能造成供電不穩定等問題，每趟飛行前須注意仔細檢查，防止機件及電子零件故障而引發不可預期的意外。

MANUAL LINK 設定操作連結

MICROBEAST PLUS Flybarless System is the latest version out of the factory, please feel at ease using it. You can also link to BEASTX MICROBEAST PLUS/HD website to get the latest version and the latest news. MICROBEAST PLUS Flybarless System has available some different versions, each version has different programming and function, please make sure your Microbeast version and read its correct manual carefully before assembly or upgrading, especially you are upgrade from your V3.2.X. to V4.X.X by yourself, in order to avoid mistake or loss by any misunderstanding, please be sure that you have correct version and follow its setting method accordingly. And please refer to MICROBEAST PLUS V3.2.x and V4.2 instruction manual for operating and setting.

MICROBEAST PLUS 無平衡翼系統，出廠時主程式已是最新版本。您也可以連結至 BEASTX MICROBEAST PLUS/HD 官網查詢，隨時更新最新版本及各項最新訊息。部分版本因升級而設定及功能會有所不同，請確定您的版本並詳閱其說明書，尤其您是由 V3.2.x 升級至 V4.x.x，請務必深入了解版本之間的設定功能，以免錯誤而造成損失。操作設定請同時參閱 V3.2.x 版及 V4.2 版使用說明書。



Please visit Align download area to get the completed instruction manual at Align website.

更多詳細的設定操作說明請至官網下載專屬下載。
<http://www.align.com.tw/beastx/>



MICROBEAST PLUS
FLYBARLESS SYSTEM FOR HD MODELS
Optional Equipment
選購品

PARTS IDENTIFICATION 各部位名稱

MICROBEAST PLUS FLYBARLESS SYSTEM 無平衡翼系統

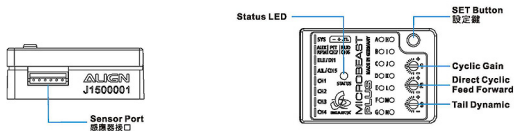

MICROBEAST PLUS FLYBARLESS SYSTEM WIRING DIAGRAM 無平衡翼系統接線示意圖

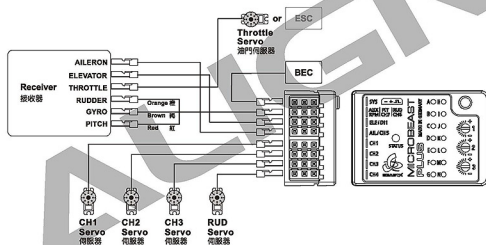

For detail connectivity, please scan QR Code then follow MICROBEAST PLUS manual.

詳細接線方式，請掃描QR Code 連結至MICROBEAST PLUS說明書。



MICROBEAST PLUS HD Flybarless System(Optional) MICROBEAST PLUS HD無平衡翼系統(選配)

If assembling and operating the helicopter without using ALIGN standard equipment, including electronic equipment & blades...etc, please make sure there is a sufficiently large and stable power supply to your helicopter. If there is any abnormal voltage or insufficient power supply, suggest to upgrade the flybarless system to MICROBEAST PLUS HD (Optional) for better power back up. Please refer to BEASTX website for MICROBEAST PLUS HD assembly and setup instruction.

安裝、操作您的真昇機時，如非使用ALIGN標準配件(含電子配件、主旋翼等)，請務必確定您的供電系統有足夠的供電能力，如發現電壓異常、供電不足，建議您升級使用MICROBEAST PLUS HD無平衡翼系統(選配)，以能確保充足、穩定的接收器電源。MICROBEAST PLUS HD使用、設定、接線，請參照MICROBEAST PLUS HD官方說明。

To set this option is to turn on the transmitter and connect to BEC power.

Note: For the safety, please do not connect ESC to the brushless motor in order to prevent any accident caused by the motor running during the setting.

此項設定只要將啟發射器，接上BEC電源即可進行操作。

注意：為了安全起見，設定前請先不要將無刷調速器與無刷馬達三線接上，以免調整時啟動馬達而發生危險。

SERVO CONFIGURATION 伺服器配置

Following the servo configuration diagram on right, plug the servos to Gyro.

請依照右圖顯示的伺服器名稱，將伺服器接到陀螺儀。

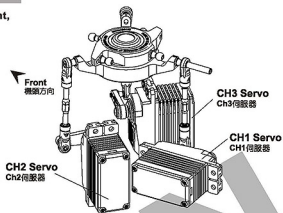

ADJUSTMENTS FOR GYRO AND TAIL NEUTRAL SETTING

陀螺儀與尾翼中立點設定調整

ALIGN

Turn off Revolution mixing (RVMX) mode on the transmitter, then set the gain switch on the transmitter and the gyro to non-head lock mode, or disable gain completely. After setting the transmitter, connect the helicopter power and proceed with rudder neutral point setting. **Note:** When connecting to the helicopter power, please do not touch tail rudder stick and the helicopter, wait for 3 seconds for gyro to enable, and the rudder servo horn should be 90 degrees to the tail servo. Tail pitch slider should be half way on the tail output shaft. This will be the standard rudder neutral point. After completing this setting, set the gain switch back to heading lock mode, with gain at around 70%.

發射器內陀螺儀設定請關閉傾轉控制模式，並將發射器上的感度開關與陀螺儀切至“非鎖定模式”或將陀螺儀感度關閉。發射器設定完成後接上自昇機電源，即可進行尾舵中立點設置。注意：當接上自昇機電源時請勿撥動尾舵搖桿或碰觸機體，待3秒陀螺儀開機完成後，尾舵伺服臂與尾向伺服器約成90度，尾旋翼控制組須正確置於尾橫軸的中間位置，即為標準尾舵中立點設定。設定完成後，切換至“鎖定模式”，感度設約70%左右。

TAIL NEUTRAL SETTING 尾中立點設定

After the gyro is enable and under non-head lock mode, correct setting position of tail servo and tail pitch assembly is as photo. If the tail pitch assembly is not in the middle position, please adjust the length of rudder control rod to trim.

陀螺儀開機後，在非鎖定模式下，尾向伺服器與尾 Pitch 控制組正確擺置位置。若尾 Pitch 控制組未置中時請調整尾舵控制桿的長度來修正。

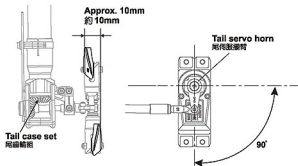

HEAD LOCK DIRECTION SETTING OF GYRO 陀螺儀鎖定方向設定

To check the head lock direction of gyro is to move the tail clockwise and the tail servo horn will be trimmed counterclockwise. If it trims in the reverse direction, please switch the gyro to "REVERSE".

陀螺儀鎖定方向確認，當手搖尾部順時鐘擺動，尾向伺服臂反時鐘修正，反向時請切換陀螺儀上“鎖定反向”開關修正。

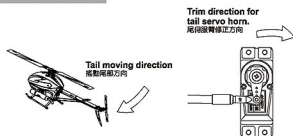

GENERAL FLIGHT 一般飛行模式

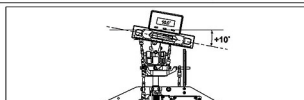

Stick Position at High/Throttle 100%/Pitch+10°
搖桿高速/油門 100%/Pitch+10°

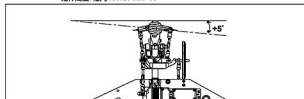

Stick Position at Hovering/Throttle 60%/Pitch+5°
搖桿停懸/油門 60%/Pitch+5°

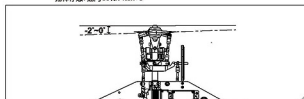

Stick Position at low/Throttle 0%/Pitch-2°~0°
搖桿低速/油門 0%/Pitch-2°~0°

3D FLIGHT 3D特技飛行模式

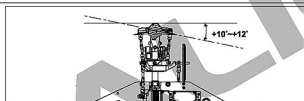

Stick position at high/Throttle 100%/Pitch+10°~+12°
搖桿高速/油門 100%/Pitch+10°~+12°

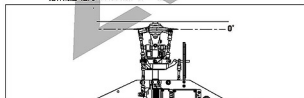

Stick position at middle/Throttle 60%~65%/Pitch 0°
搖桿中速/油門 60%~65%/Pitch 0°

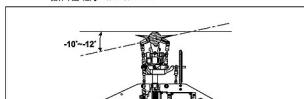

Stick position at low/Throttle 100%/Pitch-10°~-12°
搖桿低速/油門 100%/Pitch-10°~-12°



1. Pitch range : Approx 25 degrees.
2. If the pitch is set too high, it will result in shorter flight duration and poor motor performance.
3. Setting the throttle to provide a higher speed is preferable to increasing the pitch too high.

1. 螺距 (Pitch) 總行程約 25 度。
2. 過大螺距設定，會導致動力與飛行時間降低。
3. 動力提升以較高轉速的方式，優於螺距過大的設定。

GENERAL FLIGHT 一般飛行模式

| Throttle 油門 | Pitch 螺距 |
|---------------------------|----------|
| 5 100% High Speed 100% 高速 | +10° |
| 4 80% | |
| 3 60% Hovering 60% 停懸 | +5° |
| 2 40% | |
| 1 0% Low Speed 0% 低速 | -2°~0° |

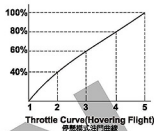

IDLE 1 : SPORT FLIGHT

| Throttle 油門 | Pitch 螺距 |
|-------------|-----------|
| 5 100% | +10°~+12° |
| 4 75% | |
| 3 60% | +5° |
| 2 65% | |
| 1 70% | -5° |

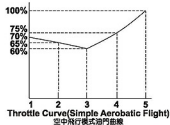

IDLE 2 : 3D FLIGHT

| Throttle 油門 | Pitch 螺距 |
|----------------------------|-----------|
| 5 100% High 100% 高 | +10°~+12° |
| 3 60%~65% Middle 60%~65% 中 | 0° |
| 1 100% Low 100% 低 | -10°~+12° |

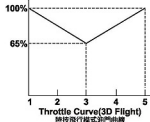

INSTRUCTION 安裝使用說明

Fig.1

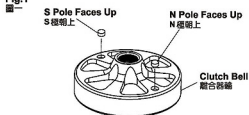

※ In order to balance the clutch bell when operation, please install two magnets.
 ※ 為了離合器鐘運轉平衡，磁鐵務必裝置兩顆。

Fig.2

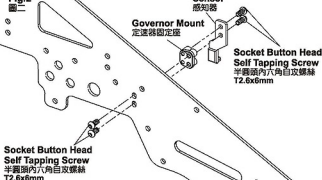

NOTE: The safty RPM is up to 16000rpm for OS90 engine.

註：OS90引擎安全轉速上限16000rpm。



Combustion Drive System (Nitro/Gas), Particularly when using sensors for combustion engines check for correct polarity of the sensor power supply on the adapter cable.

燃燒驅動系統(引擎)，當感應器使用在引擎直昇機時，請特別注意感應器電源供應與連接線的極性是否正確。

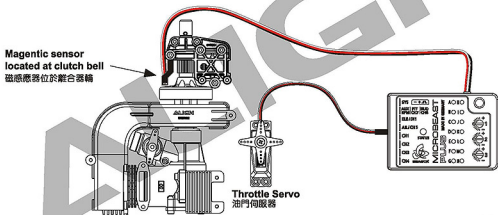

Throttle at mid stick position
油門蓋在中間



After install the engine into the model, please loosen the fixing screw and adjust the carburetor and the engine are at an angle of 90° (Vertical).
引擎裝入機體後請鬆開固定螺絲將化油器調成與引擎垂直。

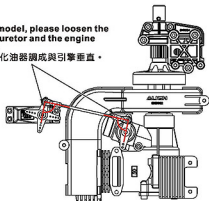

For transmitter throttle curve setup, please refer to Microbeast PLUS (V5.x.x) manual, Nitro Mode setup.
Manual download : <http://www.align.com.tw/manuals/flybarless/>

遙控器的油門曲線數據，請參考 Microbeast PLUS 無平衡翼系統 (V5.x.x專用)說明書內引擎模式調整，完整的說明書請至官網下載專屬下載。
<http://www.align.com.tw/manuals/flybarless/>

FEATURES 功能說明

1. Due to the unique 2 in 1 design, the regulator's functions provide power to the receiver, servos, and the internal glow plug ignition system that does not require you to remove the clip lead.
2. The linear regulator design results in no interference to the receiver. The required input power may only consist of a 2 cell Li-Ion or a Li-Poly battery.
3. When the integrated power switch is moved to the on position, the voltage indicating LED's and ignition indicating LED's will illuminate displaying the status of the battery voltage, and of the plug ignition function.

1. 獨特的二合一設計，除了具備(BEC)降/穩壓系統，以提供接收器與伺服器電源的功能外，還內建一組火星塞的點火裝置，省去傳統電夾插拔的麻煩。
2. 本產品採用線性設計，輸入電源為2CELL的Li-Ion或Li-Poly電池，其優點為不會像交換式設計的BEC會產生干擾接收器的情形，免於掉機的恐懼。
3. 具備電源開關、電壓指示燈及點火指示燈功能，可由燈號判定電池殘量與火星塞的點火狀態。

SPECIFICATIONS 產品規格/配件

1. Input Voltage : DC 7.4V 2 cell Lithium or Li-Poly battery
2. Output Voltage : DC 7.4V(BEC)/ 1.5V(Glow Plug)
3. Max. Continuous Current : 6A
4. Weight : 51.2g (Including wires)
5. Regulator size : 73x32.5x13mm
Control board size : 35x24x10mm

1. 輸入電壓：DC 7.4V 2CELL 鋰電
2. 輸出電壓：DC 7.4V(BEC)/ 1.5V(Glow Plug)
3. 最大連續輸出電流：6安培
4. 重量：51.2g (含線組)
5. 尺寸：降壓器 73x32.5x13mm
控制板 35x24x10mm

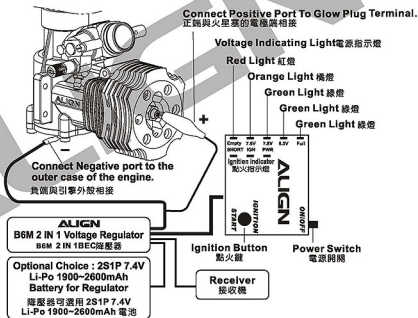

INSTRUCTION 安裝使用說明

Receiver and Servo Voltage Regulating Functions :

1. The Auto-detecting voltage LED's will display a series of lights when turned on. If the entire five-light array is illuminated then the battery is fully charged. When the voltage drops below 7.6V the three green lights will turn off. **USE CAUTION:** Once the green lights are no longer illuminated the battery can only be safely used for a single flight. When only the single red LED is lit, DO NOT ATTEMPT TO OPERATE THE MODEL. The battery voltage has been drained too low, and must be recharged before its next use.
2. 7.4V output 2 in 1 Voltage Regulator BEC must compatible with HV servos, make sure not to use 6V servos for it.

接收器與伺服機電源部份：

1. 本產品具備電壓指示功能，當接入充飽的電池時五顆指示燈全亮，表示電池在Full電量充足狀態下；使用中當電壓降低至7.6V時(3顆綠燈熄滅)，尚可完成單趟飛行即須對電池充電或更換新電池；而如果僅亮紅燈時表示Empty電量不足，不應該再使用罷！
2. 二合一降壓器BEC輸出為7.4V，必須搭配高壓伺服器使用，嚴禁搭配使用一般6V輸出的伺服器。

Glow Plug Ignition System Functions :

1. Start by connecting the wires using the included diagram as a reference. Once completed connect the battery and move the power switch to the on position. Depress the "START" button on the control board. The green and the orange lights will illuminate. When this happens the glow plug is being ignited for a period of 15 seconds. After 15 seconds, the control board will stop igniting the glow plug. If the engine has not yet been started, the process can be repeated by simply depressing the "START" button. The Ignition system is designed to automatically shut off once the engine starts running. To ensure that the system is operating properly, check to make sure that the orange and green lights have shut off once the engine starts running. In the event that the lights are still illuminated once the engine is running, it may be necessary to remove the lead clip from the engine.
2. If the orange light is not illuminated after pressing "START" then this means that the glow plug is not being ignited. Please check to see if the element of the glow plug has burned out, or if the lead clip is not properly connected to the glow plug.
3. If the Glow plug is short-circuited or the lead clip has contacted the outer case of the engine, the red (SHORT) light will be illuminated approx. 1 second after pressing the "START" button. If the "SHORT" light illuminates the system will automatically shut off the power to the output leads.

NOTE : Please use double-sided foam tape or hook & loop tap to fix the regulator on the helicopter. Please do not tighten the wires of regulator hard to avoid the wires loose or broken caused by the vibration during the operation of the helicopter.

火星塞點火器部分：

1. 依按線示意图完成接線後，開啓電源開關，接著按下控制電路板上的"START"鍵，此時點火指示燈的綠燈與橘燈同時亮起，表示火星塞已正常點火中，每次點火時間約為15秒，15秒後自動關閉，如需再次點火時，則再按一次"START"鍵，由於點火狀態會自動關閉，所以引擎啓動後，確認橘色、綠色指示燈於15秒後熄滅，即不須將鱷魚夾移除。
2. 若按下"START"鍵時，橘燈不亮，表示火星塞不正常點火，請檢查火星塞加熱線是否開路損壞，或是鱷魚夾未確實夾在火星塞電極端上。
3. 如果火星塞發生短路或是鱷魚夾（電源正端）與引擎外殼接觸時，當按下"START"鍵，紅色(SHORT)指示燈會亮起，約1秒後熄滅並隨即關閉電源輸出，請檢查火星塞是否損壞或檢查鱷魚夾是否接觸到引擎外殼。

注意：請使用泡棉雙面膠或魔術貼將降壓器與直昇機固定，降壓器的各條線請勿纏繞固定，以免直昇機旋轉時因震動造成接觸點脫落斷線。

FLIGHT ADJUSTMENT AND SETTING

飛行動作調整與設定

ALIGN

PLEASE PRACTICE SIMULATION FLIGHT BEFORE REAL FLYING 飛行前請事先熟練電腦模擬飛行













A safe and effective practice method is to use the transmitter flying on the computer through simulator software sold on the market. Do a simulation flight until you familiarize your fingers with the movements of the rudders, and keep practicing until the fingers move naturally.

1. Place the helicopter in a clear open field (Make sure the power OFF) and the tail of helicopter point to yourself.
2. Practice to operate the throttle stick (as below illustration) and repeat practicing "Throttle high/low", "Aileron left/right", "Rudder left/right", and "Elevator up/down".
3. The simulation flight practice is very important, please keep practicing until the fingers move naturally when you hear operation orders being call out.

在這邊瞭解直昇機各動作的操控方式前，嚴禁實機飛行，請先進行電腦模擬飛行的練習，一樣最有效、最安全的練習方式，就是透過市面販售的模擬軟體，以遙控器在電腦上模擬飛行，熟悉各種方向的操控，並不斷的重複，直到手指可熟練的控制各個動作及方向。

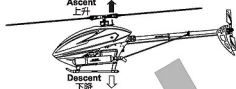
1. 將直昇機放在空曠的地方(確認引擎為熄火狀態)，並將直昇機的機尾對準自己。
2. 練習操作遙控器的各搖桿(各動作的操作方式如下圖)，並反覆練習油门高/低、副翼左右、升降舵前後及方向舵左右操作方式。
3. 模擬飛行的練習相當重要，請重複練習直到不需思索，手指能自然隨著喊出的指令移動控制。



| Mode 1 | Mode 2 | Illustration 圖示 |
|---|--------|---|
|  Aileron 副翼  | |  |
|  Elevator 升降/前後  | |  |
|  Throttle 油門  | |  |
|  Rudder 方向  | |  |

FLIGHT ADJUSTMENT AND NOTICE 飛行調整與注意

CAUTION 注意

- ⊙ Check if the screws are firmly tightened.
- ⊙ Check if the transmitter and receivers are fully charged.
- ⊙ 再次確認→螺絲是否鎖固?
- ⊙ 發射器和接收器電池量是否足夠。

- When arriving at the flying field.
- 當抵達飛行場



CAUTION 注意

If there are other radio control aircraft at the field, make sure to check their frequencies and tell them what frequency you are using. Frequency interference can cause your model, or other models to crash and increase the risk of danger.

假使飛行場有其他遙控飛機，請確認他們的頻率，並告知他們你正在使用的頻率，相同的頻率會造成干擾導致失控和大大地增加風險。

ENGINE START PREPARATION 引擎啟動事前準備

Separate the fuel tube and the joint and start to refuel. Please be careful to avoid the dust entering the tube. When the fuel tank is full, please stop refueling and reconnect the tube and the joint.

將油管與其接頭分離，並開始補給燃料。請小心避免灰塵顆粒進入管子內。當油箱已滿，請停止補給燃料並再將管子和接頭接合。

CAUTION 注意

For engine adjustment and precautions, please refer to the factory manual for more instruction.

引擎各項調整及注意事項，請參照原廠使用說明書。



Mode 1



Mode 2

CAUTION 注意

First check to make sure no one else is operating on the same frequency. Then place the throttle stick at lowest position and turn on the transmitter.

首先確認附近沒有其他相同頻率的使用，然後打開發射器將油門搖桿推到最低點。

CAUTION 注意

Check if the throttle stick is set at the lowest position and check if engine throttle is at low speed.

確認油門搖桿是在最低的位置，並確認引擎油門量於低速。

GLOW PLUG IGNITION METHOD 火星塞點火方式

Method 1
方式一

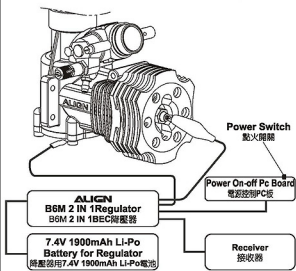

Method 2
方式二

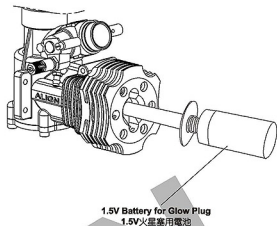

ENGINE START AND STOP 引擎啟動和熄火

1. Connect the battery to the starter and check the rotation direction. Insert the starter shaft into the starter completely.
 2. Tightly hold the main rotor head, and insert the starter shaft into the starter coupling. Then turn the starter to start the engine.
 3. When the engine starts, stop the starter and remove it from the starter coupling. Please keep holding the main rotor head tightly.
 4. Hold the main rotor head tightly, and turn off the power of glow plug or remove the power.
 5. Still hold the main rotor head tightly, turn throttle trim at the lowest position, and keeping engine in lowest regular running.
 6. If you want to stop the engine, please set the throttle trim (beside the throttle stick) at the lowest position. If the engine cannot stop, please put the Fuel Clip into lock position to stopping refueling.
1. 將啟動電池連接到啟動器並確認其轉動方向。將啟動軸完全插入啟動器。
 2. 緊緊抓住主旋翼頭部，將啟動軸插入引擎啟動頭並以啟動器啟動引擎。
 3. 當引擎啟動後，停止啟動器並將啟動頭上的啟動器移開。請保持繼續緊抓住主旋翼頭部。
 4. 仍然緊抓住主旋翼頭部，將火星塞點火電池關閉或移開。
 5. 仍然緊抓住主旋翼頭部，請保持油門於最低點時，引擎能保持於低速下正常運轉。
 6. 欲將引擎熄火時，只需將油門搖桿旁的油門破調調整至最低即可；如果引擎仍無法停止，請將油管夾片推至鎖定位置，關閉油料供給。

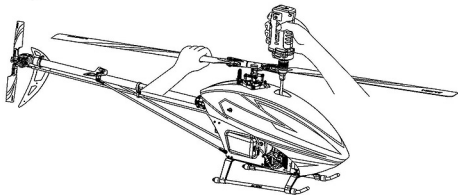

This procedure is best performed on soft surfaces such as grass. The use of rubber skid stopper is recommended on hard surface to prevent vibration feedback from the ground to flybarless sensors, resulting in over-corrections.

將直昇機置於柔軟地面上，建議硬地起飛腳架裝上避震墊圈。避免升空前腳架與過硬的地面震動太大反饋至機身上的無平衡感應器，影響無平衡系統升空前過度修正。

Rubber Skid Stoppers Installed 裝上避震墊圈



CAUTION
注意

If swashplate should tilt prior to lift off, do not try to manually trim the swashplate level. This is due to vibration feedback to the sensor, and will disappear once helicopter lifts off the ground. If manual trim is applied, helicopter will tilt immediately after lift off.

直昇機離地前，十字盤可能因感應器受震動的反應，使十字盤有傾斜的情形，此時請勿刻意將十字盤修正為水平狀態，此現象只要離地升空時立即解除，可平穩升空；若刻意將十字盤修正為水平時，反而會造成感應器過度修正，一離地即偏往修正方向的危險。

MAIN ROTOR ADJUSTMENTS 主旋翼雙槳平衡調整

1. Before adjusting, apply a red piece of tape on one blade, or paint a red stripe with a marker or paint to identify on blade.
2. Raise the throttle stick slowly and stop just before the helicopter lifts-off ground. Look at the spinning blades from the side of the helicopter.
3. Look at the path of the rotor carefully. If the two blades rotate in the same path, it does not need to adjustment. If one blade is higher or lower than the other blade, adjust the tracking immediately.

1. 調整前先在其中一支主旋翼的翼端，貼上有顏色的貼紙或畫上顏色記號，方便雙槳調整辨識。

2. 慢慢的推起油门桿停到高點並且停止，在飛機離地前，從飛機側邊觀察主旋翼轉動。

3. 仔細觀察雙旋翼軌跡(假如兩支旋翼移動都是相同軌跡，則不需要調整;可是如果一支旋翼較高或較低產生“雙槳”的情形時，則必須立刻調整軌跡)。

A. When rotating, the blade with higher path means the pitch too big. Please shorten DFC ball link for regular trim.

B. When rotating, the blade with lower path means the pitch too small. Please lengthen DFC ball link for regular trim.

A. 旋翼轉動時較高軌跡的主旋翼表示螺距(PITCH)過大，請調DFC連桿修正。

B. 旋翼轉動時較低軌跡的主旋翼表示螺距(PITCH)過小，請調DFC連桿修正。

CAUTION
注意

Tracking adjustment is very dangerous, so please keep away from the helicopter at a distance of at least 10m.

調整軌跡非常危險，請於距離飛機最少10公尺的距離。

Incorrect tracking may cause vibrations. Please repeat adjusting the tracking to make sure the rotor is correctly aligned. After tracking adjustment, please check the pitch angle is approx. 5° when hovering.

不正確的旋翼軌跡會導致震動，請不斷重複調整軌跡，使旋翼軌跡精準正確。

在調整軌跡後，確認一下Pitch角度在停旋時應為大約5°。

Color Mark 有標示記號的主旋翼

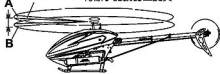

FLIGHT ADJUSTMENT AND NOTICE 飛行調整與注意

FORBIDDEN
禁止



⊗ Do not attempt to grab or make contact with the helicopter while the main blades are in motion and keep your eyes away from the helicopter. During take-off, landing, and flight, be sure to keep the helicopter away from all obstacles. Operators must stand at least 10 meters away from the helicopter to avoid injury caused by loose parts due to improper assembly or any unforeseen dangers.

⊗ 嚴禁用手抓取運行中的直昇機，並禁止將直昇機對著眼睛，當主旋翼轉動後，或起飛/試飛時，務必遠離障礙物，站立位置必需距離10公尺以上，避免因人為組裝不當造成零件脫落，而引發不可預期的財物及人員損傷。

CAUTION
注意

⊗ Make sure that no one or obstructions in the vicinity.

⊗ For flying safety, please carefully check if every movement and directions are correct when hovering.

⊗ 確認鄰近地區沒有人和障礙物。

⊗ 為了飛行安全，您必須先確認停旋時各項操控動作是否正常。

CAUTION
注意

Do not attempt to fly until you have some experiences with the operation of helicopter.

嚴禁無熟練操控飛行經驗者操控飛行。

STEP 1 THROTTLE CONTROL PRACTICE 油門控制練習

- When the helicopter begins to lift-off the ground, slowly reduce the throttle to bring the helicopter back down. Keep practicing this action until you control the throttle smoothly.
- 當直昇機開始離地時，慢慢降低油門將飛機降下。持續練習飛機從地面上升和下降直到你覺得油門控制很順。

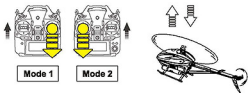

STEP 2 AILERON AND ELEVATOR CONTROL PRACTICE 副翼和升降控制練習

1. Raise the throttle stick slowly.
2. Move the helicopter in any direction back, forward, left and right, slowly move the aileron and elevator sticks in the opposite direction to fly back to its original position.

1. 慢慢升起油門搖桿。
2. 使直昇機依指示：移動向後/向前/向左/向右，慢慢的反向 移動副翼和升降搖桿並將直昇機回到原來位置。



- If the nose of the helicopter moves, please lower the throttle stick and land the helicopter. Then move your position diagonally behind the helicopter 10m and continue practicing.
- If the helicopter flies too far away from you, please land the helicopter and move your position behind 10m and continue practicing.
- 當直昇機頭偏移時，請降低油門並且降落，然後移動自己的位置到直昇機的正後方10公尺再繼續練習。
- 假如直昇機飛離您太遠，請先降落直昇機，並到直昇機後10公尺再繼續練習。

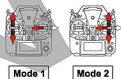
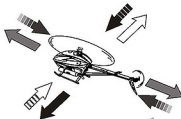

STEP 3 RUDDER CONTROL PRACTICING 方向舵操作練習

1. Slowly raise the throttle stick.
2. Move the nose of the helicopter to right or left, and then slowly move the rudder stick in the opposite direction to fly back to its original position.

1. 慢慢升起油門搖桿。
2. 將直昇機頭移動左或右，然後慢慢反向移動方向舵搖桿並將直昇機飛回原本位置。

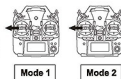

STEP 4

After you are familiar with all actions from STEP1 to 3, draw a circle on the ground and practice within the circle to increase your accuracy.

- You can draw a smaller circle when you get more familiar with the actions.

當您覺得 STEP1~3 動作熟悉了，在地上畫個圈並在這個圈內的範圍內練習飛行，以增加您操控的準確度。

- 當您更加習慣操作動作，您可以畫更小的範圍。



STEP 5 DIRECTION CHANGE AND HOVERING PRACTICE 改變直昇機方向和練習停懸

After you are familiar with STEP1 to 4, stand at side of the helicopter and continue practicing STEP1 to 4. Then repeat the STEP1 to 4 by standing in front of the helicopter.

當您覺得STEP1~4動作熟悉了，站在面對直昇機側邊並繼續練習STEP1~4。之後，站在直昇機機頭前方重複步驟練習。

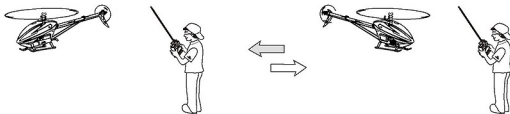

| | Problem 狀況 | Cause 原因 | Solution 對策 |
|----------------------------|---|--|---|
| Blade Tracking 雙槳平衡 | Tracking is Off 雙槳 | Pitch linkage rods are not even length PITCH連桿長度調整不平均 | Adjust length of ball link. 調整連桿球長度 |
| Hover 停懸 | Head speed too low 主旋翼轉速偏低 | Excessive pitch 主旋翼的PITCH偏高 | Adjust ball link to reduce pitch by 4 to 5 degrees. Hovering head speed should be around 1700-1800RPM. 調整連桿球降低Pitch約+4-5度 (停懸時主旋翼需為約1700-1800RPM) |
| | | Hovering throttle curve is too low 停懸點油門曲線過低 | Increase throttle curve at hovering point on transmitter (around 60%) 調高停懸點油門曲線(約60%) |
| | Head speed too high 主旋翼轉速偏高 | Not enough pitch 主旋翼的PITCH偏低 | Adjust ball link to increase pitch by 4 to 5 degrees. Hovering head speed should be around 1700-1800RPM. 調整連桿球調高Pitch約+4-5度 (停懸時主旋翼需為約1700-1800RPM) |
| | | Hovering throttle curve is too high 停懸點油門曲線過高 | Decrease throttle curve at hovering point on transmitter (around 60%) 調低停懸點油門曲線(約60%) |
| Rudder Response 尾舵反應 | Drifting of tail occurs during hovering, or delay of rudder response when centering rudder stick. 停懸時尾翼向某一邊偏移，或發動方向舵並回零到中立點時，尾翼產生延遲，無法停駐在所控制位置上。 | Rudder neutral point improperly set 尾舵中立點設定不當 | Reset rudder neutral point 重設尾舵中立點 |
| | Tail oscillates (hunting, or wags) at hover or full throttle 停懸或全油門時尾翼左右來回搖擺。 | Rudder gyro gain too low 尾舵陀螺儀感度偏低 | Increase rudder gyro gain 增加尾舵陀螺儀感度 |
| | | Rudder gyro gain too high 尾舵陀螺儀感度偏高 | Reduce rudder gyro gain 降低尾舵陀螺儀感度 |

If above solution does not resolve your issues, please check with experienced pilots or contact your Align dealer.

※在做完以上調整後，仍然無法改善情況時，應立即停止飛行並向有經驗的飛手諮詢或連絡您的經銷商。

Thank you for purchasing and supporting ALIGN products.

The Align Team is dedicated to you by innovating and developing new RC Helicopters, Multicopters, and FPV Racing Quads. We strive to provide a more diversified experience for our customers. Visit our website at www.align.com.tw for latest news, information, and updates about our extensive line of products for the RC enthusiasts.

Good Flying!

再次感謝您對亞拓系列商品的喜愛與支持，您的肯定是對我們最大的認同。

亞拓團隊秉持創新研發的精神，開發遙控直昇機／多軸飛行機／穿越機系列商品，提供給您體驗更多樣化的飛行樂趣。您可以透過下列連結，隨時瞭解亞拓的最新動態，以及各項訊息分享。

祝福您有一個愉快的飛行體驗。



ALIGN Flight Safety 亞拓飛行安全宣導
<http://www.align.com.tw/flysafe-en/>



ALIGN T-REX Helicopter 亞拓遙控直昇機
<http://www.align.com.tw/helicopter-en/>



ALIGN Multicopter 亞拓多軸飛行機
<http://www.align.com.tw/multicopter-en/>



ALIGN FPV Racing Quad 亞拓穿越機
<http://www.align.com.tw/multicopter-en/mr25/>



ALIGN Website 亞拓官網
<http://www.align.com.tw>



ALIGN Shopping Cart 亞拓購物車
<http://shop.align.com.tw/index.php?language=en>



ALIGN Quick Finder 亞拓零件快速購
<http://shop.align.com.tw/partfinder.php?language=en>



ALIGN FaceBook
<https://www.facebook.com/Align-Corporation-194493419543/?ref=mf>



ALIGN Instagram
<https://instagram.com/aligncorporation/>



ALIGN YouTube
https://www.youtube.com/channel/UCaPj_K5DNo7HSmP1eytUvMQ



ALIGN Youku
<http://i.youku.com/u/UMTQ0NjEwNjczNg==>

ALIGN

ALIGN

Specifications & Equipment/規格配備:

Length/機身長: 1152mm

Height/機身高: 356mm

Main Blade Length/主旋翼長: 550mm

Main Rotor Diameter/主旋翼直徑: 1254mm

Tail Rotor Diameter/尾旋翼直徑: 260mm

Engine Pinion Gear/引擎主齒: 20T

Main Drive Gear/傳動主齒: 170T

Autorotation Tail Drive Gear/尾驅動主齒: 180T

Tail Drive Gear/尾翼傳動齒: 40T

Drive Gear Ratio/齒輪傳動比: 8.5 : 1 : 4.5

Fuel Tank Capacity /油箱容量: 440cc.

Flying Weight/全配重: Approx. 3400g

