

Super Combo **DOMINATOR**
TREX 470LM
INSTRUCTION MANUAL

ALIGN

使用說明書

RH47E01XT
 RH47E06XT



Contents	
1	INTRODUCTION 前言
1-2	SAFETY NOTES 安全注意事項
3	EQUIPMENT REQUIRED FOR ASSEMBLY 自備設備
3	PACKAGE ILLUSTRATION 包裝說明
4	MODEL STANDARD EQUIPMENT DIFFERENCE 標準配備與本說明
6	SAFETY CHECK BEFORE FLYING 飛行前安全檢查重要事項
6-18	ASSEMBLY SECTION 組裝說明
19	EQUIPMENT INSTALLATION 各項設備安裝
20	BATTERY INSTALLATION ILLUSTRATION 電池安裝示意圖
20	CANOPY ASSEMBLY 機頭罩安裝
21	ELECTRIC EQUIPMENT ILLUSTRATION 電子設備連接配置圖示
21-22	MICROBEAST PLUS FLYBARLESS MANUAL 無平衡槓系統使用說明
23	SERVO SETTING AND ADJUSTMENT 伺服器設定調整
23	ADJUSTMENTS FOR GYRO AND TAIL NEUTRAL SETTING 陀螺儀與尾槓中立及設定調整
24	PITCH AND THROTTLE SETTING 主旋翼槓與油門設定
25	POWER COLLOCATION REFERENCE 原裝動力線連接參考
25-28	RC-BLANK BRUSHLESS SPEED CONTROLLER INSTRUCTION MANUAL 無刷速度控制器使用說明
29-31	FLIGHT ADJUSTMENT AND SETTING 飛行動作調整與設定
32	TROUBLESHOOTING 飛行中狀況排除

Highly efficient direct belt drive control system design for pristine F3C, F3N or extreme 3D flight.

高性能皮帶直驅 動靜皆宜



BEASTX

MICROBEAST PLUS

6-AXIS MEMS SENSOR SYSTEM FOR RC-MODELS



Thank you for purchasing Align products. Please read the manual carefully before installing and be sure to retain the manual for future reference. All pictures shown are for illustration purpose only. Actual product may vary due to product enhancement. Specifications, contents of parts and availability are subject to change, ALIGN RC is not responsible for inadvertent errors in this publications.

承蒙閣下選用亞拓遙控世界系列產品，謹表謝意。使用前，請務必詳閱本說明書，相信一定能夠給您帶來相當大的幫助。也請您妥善保管本說明書，以做為日後參考。本公司將不對此印刷物之異動負責，也無法主動通知消費者任何更新或異動。所有圖片僅用於展示目的。產品可能因改良而有些不同。本說明書內記載的材質、規格或零件包裝之內容物如有異動，請依亞拓官網公告為主。

Thank you for buying ALIGN Products. The T-REX 470LM Dominator Helicopter is designed as an easy to use, full featured Helicopter R/C model capable of all forms of rotary flight. Please read the manual carefully before assembling the model, and follow all precautions and recommendations located within the manual. Be sure to retain the manual for future reference, routine maintenance, and tuning. The T-REX 470LM Dominator is a new product developed by ALIGN. It features the best design available on the R/C helicopters market to date, providing flying stability for beginners, full aerobatic capability for advanced fliers, and unsurpassed reliability for customer support.

感謝您選購這拓產品，為了讓您容易方便的使用 T-REX 470LM Dominator 直升機，請您詳細的閱讀完這本說明書之後再進行組裝以及操作這台直升機，同時請您妥善的保存這本說明書，作為日後進行調整以及維修的參考。T-REX 470LM Dominator 是由亞拓自行研發的新產品，不論您是需求飛行穩定性的初學者或是追求性能的飛行愛好者，T-REX 470LM Dominator 將是您最佳的选择。

WARNING LABEL LEGEND 標誌代表涵義

	FORBIDDEN 禁止 Do not attempt under any circumstances. 在任何禁止的環境下，請勿嘗試操作。
	WARNING 警告 Mishandling due to failure to follow these instructions may result in damage or injury. 因為疏忽這些操作說明，而使用錯誤可能造成財產損失或嚴重傷害。
	CAUTION 注意 Mishandling due to failure to follow these instructions may result in danger. 因為疏忽這些操作說明，而使用錯誤可能導致危險。

IMPORTANT NOTES 重要聲明

R/C helicopters, including the T-REX 470LM Dominator are not toys. R/C helicopter utilize various high-tech products and Technologies to provide superior performance. Improper use of this product can result in serious injury or even death. Please read this manual carefully before using and make sure to be conscious of your own personal safety and the safety of others and your environment when operating all ALIGN products. Manufacturer and seller assume no liability for the operation or the use of this product. Intended for use only by adults with experience flying remote control helicopters at a legal flying field. After the sale of this product we cannot maintain any control over its operation or usage.

As the user of this product, you are solely responsible for operating it in a manner that does not endanger yourself and others or result in damage to the product or the property of others.

T-REX 470LM Dominator 遙控直升機並非玩具，它集合了許多高科技產品所設計出來的特殊構造，所以高級的使用不謹慎或不熟悉都可能會造成嚴重傷害甚至死亡，使用之前請務必詳讀本說明書，如能熟讀並注意自身安全，注意！任何遙控直升機的使用，製造商和經銷商無法對使用者於操作使用的損耗與或組裝不當所發生之意外負任何責任，本產品是提供給有操作遙控直升機經驗的人或有相當技術的人員在符合當地合法遙控飛行場飛行，以確保安全無虞下操作使用，產品售出後本公司不負責任何操作和使用控制上的任何性能與安全責任。

做為本產品的使用者，您，是唯一一對於您自己操作的運後及行為負全部的責任之人。

We recommend that you obtain the assistance of an experienced pilot before attempting to fly our products for the first time. A local expert is the best way to properly assemble, setup, and fly your model for the first time. T-REX 470LM Dominator requires a certain degree of skill to operate, and is a consumer item. Any damage or dissatisfaction as a result of accidents or modifications are not covered by any warranty and cannot be returned for repair or replacement. Please contact our distributors for free technical consultation and parts at discounted rates when you experience problems during operation or maintenance.

As Align Corporation Limited has no control over use, setup, final assembly, modification or misuse, no liability shall be assumed nor accepted for any resulting damage or injury. By the act of use, setup or assembly, the user accepts all resulting liability.

模型商品屬於高操作技術且為高耗性之商品，如經拆裝使用後，會造成不等情況零件損耗，任何使用情況所造成商品不裝或不滿意，將無法於保固條件內更換新品或退貨，如還有使用操作疑問，本公司全體分公司或代理商將提供技術指導、特價零件供應服務，對使用者的不當使用、設定、組裝、修改、破壞或不良所造成的破壞或傷害，本公司無法控制及負責，任何使用、設定、組裝、修改、破壞或不良所造成的損耗、意外或傷害，使用者應承擔全部責任。

SAFETY NOTES 安全注意事項

CAUTION 注意

- Fly only in safe areas, away from other people. Do not operate R/C aircraft within the vicinity of homes or crowds of people. R/C aircraft are prone to accidents, failures, and crashes due to a variety of reasons including, lack of maintenance, pilot error, and radio interference. Pilots are responsible for their actions and damage or injury occurring during the operation or as a result of R/C aircraft models.
- Prior to every flight, carefully check rotorhead spindle shaft screws and tail blade grip screws, linkage balls and screws, ensure they are firmly secured.
- 遙控模型飛機、且昇機屬高危險性商品，飛行時務必遠離人群，人為組裝不當或操作損壞、電子控制設備不良，以及操作上的不熟悉，都有可能導致飛行失控損傷等不可預期的意外，請飛行者務必注意飛行安全，並需了解自負風險所造成任何意外之責任。
- 每週飛行前須仔細檢查，主翼翼尖固定螺絲、尾翼翼尖螺絲，以及機身各部位球頭、螺絲，確實上膠膠漿才能升空飛行。

**LOCATE AN APPROPRIATE LOCATION 遠離障礙物及人群**

R/C helicopters fly at high speed, thus posing a certain degree of potential danger. Choose a legal flying field consisting of flat, smooth ground without obstacles. Do not fly near buildings, high voltage cables, or trees to ensure the safety of yourself, others and your model. For the first practice, please choose a legal flying field. Do not fly your model in inclement weather, such as rain, wind, snow or darkness.

真飛機飛行時具有一定的速度，相對的會帶來一定的危險性。場地的選擇也相對的重要，請遵守當地法規到合法區域飛行場地飛行。務必選擇在空曠合法區域飛行場地，切勿靠近房屋、高壓線、樹木等，確保您、他人及您的模型的安全。第一次練習，請選擇合法的飛行場地。不要在雷雨、大風、大雪或天黑時操作，以確保本身及機體的安全。

**NOTE ON LITHIUM POLYMER BATTERIES 鋰聚電池注意事項**

Lithium Polymer batteries are significantly more volatile than alkaline or Ni-Cd/Ni-MH batteries used in RC applications. All manufacturer's instructions and warnings must be followed closely. Mishandling of Li-Po batteries can result in fire. Always follow the manufacturer's instructions when disposing of Lithium Polymer batteries.

鋰聚電池跟一般用在RC用的鹼性電池、鎳鎘電池、鎳氫電池比較起來要相對的危險。請嚴格遵守鋰聚電池說明書之使用注意事項，不恰當使用鋰聚電池，可能釀成火災甚至危及生命財產安全，切勿大意！

**PREVENT MOISTURE 遠離潮濕環境**

R/C models are composed of many precision electrical components. It is critical to keep the model and associated equipment away from moisture and other contaminants. The introduction or exposure to water or moisture in any form can cause the model to malfunction resulting in loss of use, or a crash. Do not operate or expose to rain or moisture.

真飛機內部也是由許多精密的電子零件組成，所以必須絕對的防止潮濕或水氣，避免在浴室或雨天時使用，防止水氣進入機體內部的精密零件及電子零件故障而引發不可預期的意外！

**PROPER OPERATION 勿不當使用本產品**

Please use the replacement of parts on the manual to ensure the safety of instructors. This product is for R/C model, so do not use for other purpose.

請勿自行改裝加工，任何的升級改裝或維修，請使用原廠產品目錄中的零件，以確保機體的安全。請勿隨意拆裝機體內零件，請勿隨意使用，並勿用於安全、違章外其它非法用途。

**OBTAIN THE ASSISTANCE OF AN EXPERIENCED PILOT 避免獨自操控**

Before turning on your model and transmitter, check to make sure no one else is operating on the same frequency. Frequency interference can cause your model, or other models to crash. The guidance provided by an experienced pilot will be invaluable for the assembly, tuning, trimming, and actual first flight or unforeseen danger may happen. (Recommend you to practice with computer-based flight simulator.)

在飛行場飛行前，應請經驗豐富的老手指導飛行，因為頻帶相鄰的發射器將導致自己與他人立即墜毀等意外危險。高技術飛機技巧在學習初期將有一定的難度，並盡量避免獨自操作飛行，應有經驗的人士在旁指導，才可以確保飛行，否則將可能造成不可預期的意外發生。(歡迎大家模擬飛模及老手指導是入門必要的選擇)

**SAFE OPERATION 安全操作**

Do not attempt to grab or make contact with the helicopter while the main blades are in motion and keep your eyes away from the helicopter. During take-off, landing, and flight, be sure to keep the helicopter away from all obstacles. Operators must stand at least 10 meters away from the helicopter to avoid injury caused by loose parts due to improper assembly or any unforeseen dangers. Operate this unit within your ability. Do not fly under tired condition and improper operation may cause in danger. Never take your eyes off the model or leave it unattended while it is turned on. Immediately turn off the model and transmitter when you have landed the model.

嚴禁用手抓取運行中的真飛機，並禁止將真飛機對著眼睛，當主旋翼轉動後，就起飛/試飛行，務必遠離障礙物，站立位置必須距離10公尺以上，當其他人為鬆動不當造成零件脫落，而引起不可預期的對其他人及設備。請於自己能力內及範圍內，高技術飛機上應有經驗人士指導，切勿逞強，精神不佳或不擅操作，意外發生風險時可能會受傷。不可在旋翼動範圍外運行，隨後後也應馬上關閉引擎及遙控器電源。

**ALWAYS BE AWARE OF THE ROTATING BLADES 遠離旋轉中零件**

During the operation of the helicopter, the main rotor and tail rotor will be spinning at a high rate of speed. The blades are capable of inflicting serious bodily injury and damage to the environment. Be conscious of your actions, and careful to keep your face, eyes, hands, and loose clothing away from the blades. Always fly the model a safe distance from yourself and others, as well as surrounding objects.

真飛機主旋翼與尾旋翼轉動時會以高速度下運行，在高速度下的旋轉會造成自己與他人在身體上或環境上的嚴重損傷。請務必遠離旋轉中零件及周圍環境，並保持安全距離以避開這些旋轉及障礙。

**KEEP AWAY FROM HEAT 遠離熱源**

R/C models are made of various forms of plastic. Plastic is very susceptible to damage or deformation due to extreme heat and cold climate. Make sure not to store the model near any source of heat such as an oven, or heater. It is best to store the model indoors, in a climate-controlled, room temperature environment.











遙控飛機多半是以 PA 碳纖維或聚乙稀、電子元件為主要材質，因此要盡量遠離熱源、日曬，以避開因高溫而變形甚至熔毀損壞的可能。



RADIO TRANSMITTER AND ELECTRONIC EQUIPMENT REQUIRED FOR ASSEMBLY 自備遙控及電子設備



 Transmitter (6-channel or more, helicopter system) 發射器(六或以上通道飛機式遙控器)		 Receiver(6-channel or more) 接收器(六或以上)	 or Remote Receiver 遙控天線
 22.2V 6S 1,400-1,900mAh Li-Po Battery x 1 22.2V 6S 1,400-1,900mAh Li-Po 電池 x 1		 RCC-300 Intelligent Battery Charger RCC-300 智慧型充電器	

ADDITIONAL TOOLS REQUIRED FOR ASSEMBLY 自備工具

 [H47H010XXW] 47DL Swashplate Leveler 47DL 十字盤校正器	 [HET80001] AP600 Digital Pitch Gauge AP600 數位傾角尺	 [HETMT901] Multi-function Tester 多功能檢流計				
 Phillips Screw Driver 十字螺絲起子 φ 3.0 x φ 1.6mm	 Cutter Knife 刀子	 Hexagon Screw Driver 六角螺絲起子 3mm/2.5mm/2mm/1.5mm	 Needle Nose Pliers 尖嘴鉗	 Oil 潤滑油	 CA 黏合膠	 R48 殺虫膠

PACKAGE ILLUSTRATION

包裝說明

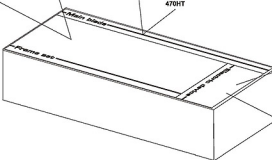
470HC2 470HM1 470HB 470HB3 470HB8 470HT2 470HT3 470HG1 470HZ5	 Canopy 機罩	 309 Carbon Fiber Blade X 1set 309 碳纖維主旋翼 X 1 組	 Quick Finder 零件快選購
		470MX (1800KV/2818) Brushless Motor x 1 470MX (1800KV/2818) 無刷馬達 x 1 RCE-0L50X Brushless ESC x 1 RCE-0L50X 線圈定速無刷電機 x 1 Optional Equipment 選購品 Microbeast PLUS Flybarless System x 1 藍芽飛控系統 x 1 DS455M Digital Servo x 1 DS455M 數位伺服馬達 x 1 DS450M Digital Servo x 3 DS450M 數位伺服馬達 x 3	

There are many versions of T-REX 470LM Dominator for your choice. The Super Combo includes additional electronics and other equipment. The Instruction Manual will refer to the T-REX 470LM Dominator Super Combo. You may purchase any additional items referenced in the instruction manual or any spare parts for other 470LM Dominator version by referring to more product information in this manual.

T-REX 470LM Dominator 系列商品有多種版本可作為選擇，按標準配備會因您購買的商品版本而有些微不同，在繪圖、設定上都是一致的，在此我們以 Super Combo 作為操作範例，您也可依照書面上的商品資訊來增添其他選購商品。



T-REX 470LM SUPER COMBO STANDARD EQUIPMENT		T-REX 470LM SUPER COMBO 標準配備		[RH47E01XT]
 470HC2	 470HH1	 470HB	 470HB8	 470HB3
 470HT2	 470HT3	 470HG1	 470HZ5	M3 Set Screw x1 M3 止位螺絲 x 1 Motor Pinion Helical Gear 11T x 1 馬達副齒輪 11T x 1
 470MX (1800KV/2818) Brushless Motor x 1 470MX (1800KV/2818) 無刷馬達 x 1	 RCE-BL50X Brushless ESC x 1 RCE-BL50X 無刷定速調速器 x 1	 Microbeast PLUS Flybarless System x 1 無平叉系統 x 1	 DS450M Digital Servo x 3 DG450M 數位伺服機 x 3 DG455M Digital Servo x 1 DG455M 數位伺服機 x 1	 380 Carbon Fiber Blade x 1 380 碳纖維主旋翼 x 1

T-REX 470LM KIT STANDARD EQUIPMENT		T-REX 470LM KIT 標準配備		[RH47E06XT]
 470HC2	 470HH1	 470HB	 470HB8	
 470HB3	 470HT2	 470HT3	 470HG1	 470HZ5
 M3 Set Screw x1 M3 止位螺絲 x 1 Motor Pinion Helical Gear 11T x 1 馬達副齒輪 11T x 1	 470MX (1800KV/2818) Brushless Motor x 1 470MX (1800KV/2818) 無刷馬達 x 1	 RCE-BL50X Brushless ESC x 1 RCE-BL50X 無刷定速調速器 x 1	 380 Carbon Fiber Blade x 1 380 碳纖維主旋翼 x 1	

CAREFULLY INSPECT BEFORE REAL FLIGHT 請嚴格執行飛行前之檢查過程

- Before flying, please check to make sure no one else is operating on the same frequency for the safety.
- Before flight, please check if the batteries of transmitter and receiver are enough for the flight.
- Before turn on the transmitter, please check if the throttle stick is in the lowest position. IDLE switch is OFF.
- When turn off the unit, please follow the power on/off procedure. Power ON- Please turn on the transmitter first, and then turn on receiver. Power OFF- Please turn off the receiver first and then turn off the transmitter. Improper procedure may cause out of control, so please to have this correct habit.
- Before operation, check every movement is smooth and directions are correct. Carefully inspect servos for interference and broken gear.
- Check for missing or loose screws and nuts. See if there is any cracked and incomplete assembly of parts. Carefully check main rotor blades and rotor holders. Broken and premature failures of parts possibly cause a dangerous situation.
- Check all ball links to avoid excess play and replace as needed. Failure to do so will result in poor flight stability.
- Check if the battery and power plug are fastened. Vibration and violent flight may cause the plug loose and result in out of control.
- 每次飛行前應先檢查所使用的頻率是否會干擾他人，以確保自身與他人的安全。
- 每次飛行前請確定您發射器與接收器電池的電量是在足夠飛行的狀態。
- 開機前請確認油门桿桿是否位於最低點，熄火旋鈕開關，定速開關 (IDLE) 是否於關閉位置。
- 開機時必須遵守電源開關的程序，開機時應先開發射器後，再開啟接收器電池；關機時應先關閉接收器後，再關閉發射器電池。不正確的開機程序可能會造成失控的現象，影響自身與他人的安全，請養成正確的習慣。
- 開機前請先確定各機械的各個動作是否順暢，及方向是否正確，並檢查伺服器的動作是否有干涉或阻礙的情形，使用故障的伺服器將導致不可預期的危險。
- 飛行前請認清有缺少或鬆動的螺絲與螺帽，確認沒有組裝不完整或損壞的零件，仔細檢查主旋翼是否有損壞，特別是接近主旋翼夾座的部位。損壞或組裝不完整的零件不僅影響飛行，更會造成不可預期的危險。注意：每次飛行前的安全檢查，保養、及更換零件，請認真嚴格執行以確保安全。
- 檢查所有的連接線是否有鬆動的情形，過鬆的連接線應先更換，否則將造成異常機械故障的危險。
- 確認電池及電器插頭是否固定牢靠，飛行中的震動或激烈的飛行，可能造成電器接頭鬆動而造成失控的危險。

When you see the marks as below, please use relative glue or grease to ensure flying safety.

標有以下符號之組裝步驟，請配合上膠或上油，以確保相關零件使用之可靠度。



• CA : Apply small amount of CA Glue to fix.

• 黏膠膠：使用適量瞬間膠固定

• R48 : Apply small amount of Anaerobic Retainer to fix.

• 鎖膠膠：使用適量鎖膠固定

• T43 : Apply small amount of Thread Lock to fix.

• 螺絲膠：使用適量螺絲膠

• OIL : Add small amount of Oil.

• 潤滑油：添加適量潤滑油

• Grease : Add small amount of Grease.

• 潤滑膏：添加適量潤滑膏

When assembling ball links, make sure the "A" character faces outside.

各鋼球膠套連接組裝時，"A"字朝外。



Keep plastic parts away from heat.
塑膠件應避免接近熱源。



CA Glue
黏膠膠



Anaerobic Retainer
鎖膠膠



Thread Lock
螺絲膠



Grease
潤滑膏



Oil
潤滑油

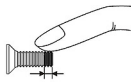

T43 Glue width : approx. 1mm
T43 上膠寬度約 1mm

1. Anaerobic Retainer (R48) is green penetrating threadlocker and is used to fix the metal tube before assembly at temperatures up to +180°C.
2. Thread Lock(T43) is blue low strength threadlocker and is applied to the small screw(threads) or metal parts before assembly to prevent loosening. Ensure to apply only a small amount and wipe surplus off. When disassembling, recommend to heat the metal joint about 15 Seconds.
3. Grease is kind of lubricant additive which is applied to the one-way bearings or thrust bearing.

ⒺBased on parts physical attributes, please apply small amount of the relative glue or grease according to prevent any parts damage or loosening or unexpected danger happened.

1. 鎖膠膠 (R48) 為綠色高強度快速固化的鎖膠膠，適合於金屬管狀固定用，可耐高溫至 180°C。
2. 螺絲膠 (T43) 為藍色低強度螺絲膠，適合小型螺絲；使用於金屬內外件或螺絲合螺絲的，請務必適量使用，必要時請用去漆多餘膠膠，拆卸時可於金屬接合部位熱約 15 秒。
3. 潤滑油 (Grease) 為膏狀潤滑油，適用於單向軸承或止推軸承。

Ⓕ上述各類功能膠(漆)類零件屬性需求自行準確斟酌其用量，以達到最佳組裝狀態，避免因使用不當造成零件損壞或不可預期的意外發生。

470HH1

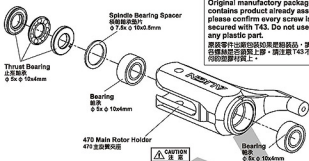
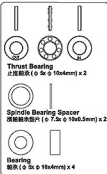

Apply a small amount of T43 thread lock when fixing a metal part.
鎖緊螺絲時於金屬件請使用適量 T43 (鎖絲膠)。

CAUTION
注意

Original manufacturer packages contains product already assembled, please confirm every screw is firmly secured with T43. Do not use T43 on any plastic part.

原廠零件出廠包裝如果原裝組裝品，請確認每顆螺絲是否鎖緊上膠，請注意 T43 不可能在任何的塑膠材質上。

CAUTION
注意

Thrust Bearing 止推軸承

470 Main Rotor Holder
470 主旋翼夾座

Apply Grease On
Thrust Bearing
止推軸承塗上潤滑油



"IN" Mark Faces Inside
"IN"字請朝內

Thin (Larger ID)
薄 (內徑較大)

Thick (Smaller ID)
厚 (內徑較小)

CAUTION
注意

Thrust bearing and washer for radial bearing are wear items, and thus should be inspected for replacement after every 20 flights. For flights with high headspeed, the inspection interval should be reduced to ensure flight safety.

止推軸承及輻射軸承墊片屬於飛行消耗品，建議每 20 趟定期檢查及更換，高主旋翼轉速飛行時，請縮短定期檢查之趟數，以確保飛行安全。

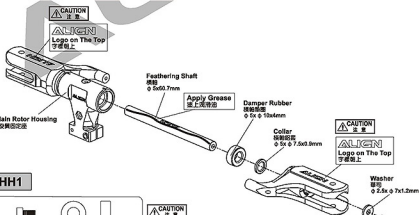

470HH1

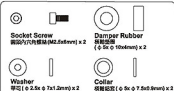

CAUTION
注意

Please apply a small amount of glue when tightening the feathering shaft socket screws and make sure to tighten firmly, but not over tighten. Suggest to use torque wrench or torque lock for tightening screws with the torque value 5.0kg.cm.

鎖緊轉軸限位時請注意塗膠附之長度與使用適量的鎖絲膠，建議鎖緊扭力扳手或扭力機鎖附螺絲，鎖緊扭力值為 5.0kg.cm。

Socket Screw
螺絲(內六角螺絲)
M2.5x5mm



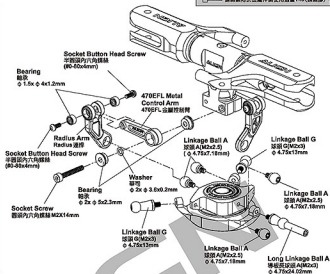

470HH1

-  **Bearing**
軸承 (φ 1.5x φ 4x1.2mm)x4
-  **Socket Button Head Screw**
半圓頭內六角螺絲(φ9-φ0x4mm) x4
-  **Linkage Ball A(M2x3)**
球頭內六角螺絲(φ 4.75x7.18mm) x 4
-  **Linkage Ball G(M2x3)**
球頭內六角螺絲(φ 4.75x7.18mm) x 2
-  **Long Linkage Ball A(M2x3)**
球頭長球頭A (M2x3) (φ 4.75x24.62mm) x 1
-  **Washer**
墊圈 (φ 2x φ 3.6x0.2mm) x 2
-  **Socket Screw**
圓頭內六角螺絲(M2x14mm) x 2

Apply a small amount of T43 thread lock when fixing a metal part.
螺絲鎖用於金屬件固定用適量T43(螺絲膠)



470HH1

-  **470 Linkage Rod(A)**
470 連桿A (M2x16mm)x 2
-  **600 Ball Link**
600 連桿球頭 x 4
-  **470EFL Linkage Ball A(M2x3)**
470EFL 球頭內六角螺絲(φ 4.75x9.92mm) x 2
-  **M2.5 Nut**
M2.5 尼龍螺母 x 1
-  **Socket Collar Screw**
圓頭內六角帶鎖螺絲 (M2.5x12mm) x 1

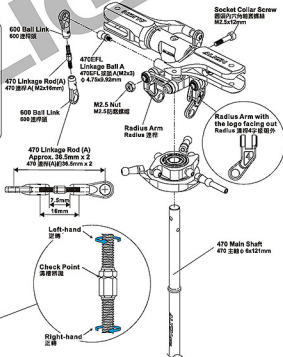

CAUTION 注意

Original manufactory packages contains product already assembled, please confirm every screw is firmly secured with T43. Do not use T43 on any plastic part.
原裝零件出廠包裝如果是組裝品，請確認每顆名螺絲是否鎖緊上膠。

CAUTION 注意

You may adjust the length of ball link when tracking is off while flight.
若飛行中有變態情形，可透過調整球頭連桿長度改善。

CAUTION 注意

For installation, make sure the "Check Point" is face upward, then use plier or wrench grasp the center of hexagonal rod to adjust its suitable length, turns clockwise to decrease the length, turns counter clockwise to increase the linkage length.

組裝時請將連桿中間行調整標點朝上。請使用尖嘴鉗或六角板手對準六角螺絲中間位置調整連桿長度，將設計標點為調整連桿長度；逆時針轉動可為調整連桿長度。

470HB2

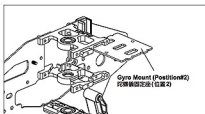
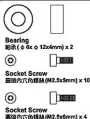

Apply a small amount of T43 thread lock when fixing a metal part.
螺絲鎖附於金屬件時請使用適量T43(螺絲膠)。

CAUTION
注意

Original manufacturer packages contains product already assembled, please confirm every screw is firmly secured with T43. Do not use T43 on any plastic part.

原廠零件包裝包含裝好與部份組裝品，請再確認每顆螺絲是否鎖緊上膠。請注意T43不可用在任何的塑膠材質上。

Bearing
滾珠
φ 6x φ 12x6mm

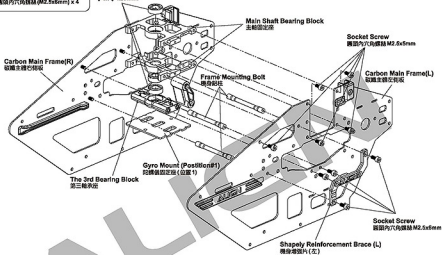

470HB2

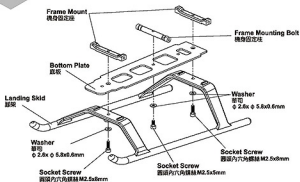

PROGRESSIVE LIGHTWEIGHT LANDING SKID

前衛新型的傾斜量化的腳架

Landing skid is tilted 5 degree forward which improves crashworthiness.

新型腳架與機殼連接，為前傾 5 度傾斜設計。





Main frame assembly key point :

First do not fully tighten the screws of main frames and put two bearings through the main shaft to check if the movements are smooth. The bottom bracket must be firmly touched the level table top(glass surface) ; please keep the smooth movements on main shaft and level bottom bracket, then slowly tighten the screws. This assembly can help for the power and flight performance.

機身保板組立重點：

保板螺絲先不完全鎖緊，放入主軸貫穿二顆軸承確認上下移動是否滑順，主軸底板必須與水平桌面(玻璃平面)確實緊貼；請保持主軸滑順與底板平行桌面後慢慢鎖緊螺絲。正確保板的組裝對動力與飛行性能有顯著幫助。

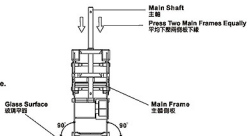

Apply a small amount of T43 thread lock when fixing a metal part.
鎖緊用於金屬件鎖件時請用適量T43(螺絲膠)。



Original manufactory packages contains product already assembled, please confirm every screw is firmly secured with T43. Do not use T43 on any plastic part.

原廠零件包內包裝如果呈組裝品，請確認再確認各樣螺絲是否鎖緊上膠。請注意T43不可用在任何的塑膠材質上。

Recommend sanding the marked position with a waterproof abrasive paper (#800-1000) as below illustration to avoid the wires of electric parts to be cut.

建議於下圖色塊標記處，可使用#800-1000 waterproof 砂紙打磨，可防止電子設備電線被刮破。

Waterproof
Abrasive Paper
水砂紙



470HB2

Socket Screw
圓頭內六角螺絲(M2.5x5mm) x 4

Socket Screw
圓頭內六角螺絲(M2.5x6mm) x 4

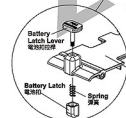

Battery Release Latch
Installation illustration
電池扣安裝示範圖

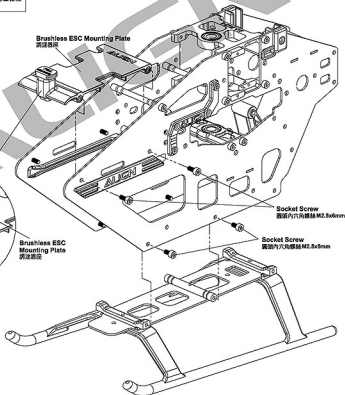

470HZ2



M2 Nut
M2 螺帽 x 3



Socket Button Head Screw
半圓頭內六角螺絲 (M2x4mm) x 3



Linkage Ball A (M2x3.5)
球頭 A (M2x3.5) (φ 4.75x9.16mm) x 1



Linkage Ball B (M2x3.5)
球頭 B (M2x3.5) (φ 4.75x11.34mm) x 3

470HB2



Socket Button Head Screw
半圓頭內六角螺絲 (M2x5mm) x 6

Apply a small amount of T43 thread lock when fixing a metal part.
鎖緊螺絲時於金屬件請使用適量 T43 (鎖絲膠)。

CAUTION
注意

Original manufactory packages contains product already assembled, please confirm every screw is firmly secured with T43. Do not use T43 on any plastic part.

原廠零件包裝包裝如果裝相製品，請再確認每條螺絲是否鎖緊上膠。請注意 T43 不可塗在任何的塑膠材質上。

Socket Button Head Screw
半圓頭內六角螺絲 M2x4mm

DS450M Digital Servo
DS450M 數位伺服馬達
Optional Equipment
選購品

D4AF Servo Horn
D4AF 伺服臂

Socket Button Head Screw
半圓頭內六角螺絲 M2x4mm

M2 Nut
M2 螺帽

Linkage Ball B (M2x3.5)
球頭 B (M2x3.5) φ 4.75x11.34mm



- DS450M Digital Servo :
1. 1520 μ s standard band / 1520 μ s 寬頻脈波
 2. Stall Torque/ 輸出扭力 : 3.5kg.cm (6.5V)
4.8kg.cm (6.4V)
6.0kg.cm (6.3V)
 3. Motion Speed/ 動作速度 : 0.06sec/60° (6.5V)
0.05sec/60° (6.4V)
 4. Dimension/ 尺寸 : 23 x 12 x 31.3mm
 5. Weight/ 重量 : 26g

DS450M Digital Servo
DS450M 數位伺服馬達
Optional Equipment
選購品

Linkage Ball B (M2x3.5)
球頭 B (M2x3.5) φ 4.75x11.34mm

D4AF Servo Horn
D4AF 伺服臂

M2 Nut
M2 螺帽

Socket Button Head Screw
半圓頭內六角螺絲 M2x4mm

Socket Button Head Screw
半圓頭內六角螺絲 M2x4mm

470HT1

Socket Screw
圓頭內六角螺絲 (M2.5x5mm) x 2

Socket Button Head Screw
平頭圓內六角螺絲 (M2.5x8mm) x 2

Bearing
軸承 (φ 2x φ 4.5x2mm) x 2

Belt Pulley
皮帶輪 (φ 4.5x φ 8x8.2mm) x 2

Tension Spring
皮帶彈簧 (φ 4x φ 5.2x11mm) x 2

Washer
墊圈 (φ 2.6x φ 5.8x0.6mm) x 1

Already assembled by factory,
please note to check again.
已組裝完成，請務必自行再確認。

Apply a small amount of T43 thread
lock when fixing a metal part.
螺絲鎖固於金屬件時使用樂泰T43(螺絲膠)。

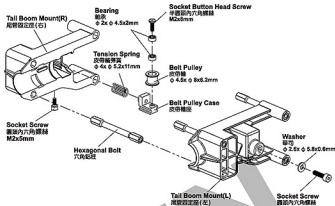

470HT1

Socket Screw
圓頭內六角螺絲 (M2.5x6mm) x 8

Socket Screw
圓頭內六角螺絲 (M2.5x10mm) x 2

Washer
墊圈 (φ 2.6x φ 5.8x0.6mm) x 1

CAUTION
注意

Original manufacturing packages
contains product already assembled,
please confirm every screw is firmly
secured with T43. Do not use T43 on
any plastic part.

原裝零件包裝如果已組裝品，請務必確認
每顆螺絲是否鎖緊上膠，請注意T43不可用在任
何的塑膠件其上。

CAUTION
注意

Gently pull belt through the tail boom
in the direction from the tail to nose
of the helicopter.
請將皮帶由尾管固定座後方穿入機身內。

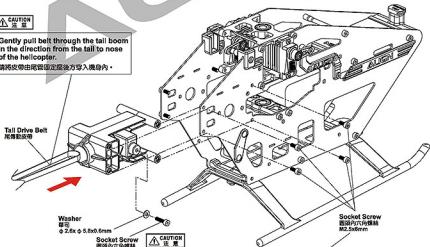

CAUTION
注意

Insert the screws; however, do not tighten! Insert the tail boom and belt, place the
belt over the pulley. Tighten all screws and confirm belt tension is correct.

先以螺絲虛鎖定位，待尾管及皮帶組裝完成後再確實鎖緊。

470HZ2



M2 Nut
M2 螺帽 x 1



Linkage Ball A (M2x3.5)
球頭 A (M2x3.5) (ø 4.75x8.18mm) x 1



Socket Button Head Screw
半圓頭內六角螺絲 (M2x6mm) x 1



Socket Button Head Self Tapping Screw
半圓頭內六角自攻螺絲 (T2x6mm) x 2

Apply a small amount of T43 thread lock when fixing a metal part.
鎖緊剛性的金屬零件時使用適量 T43 (鎖結劑)。



Original manufactory packages contains product already assembled, please confirm every screw is firmly secured with T43. Do not use T43 on any plastic part.

原廠零件包裝包裏如果是組裝品，請再確認每顆螺絲是否鎖緊上膠，請注意 T43 不可塗在任何的塑膠材質上。

470HB2



Canopy Mounting Bolt
機頭罩固定柱 (2.5x28.5mm) x 2



Socket Button Head Self Tapping Screw
半圓頭內六角自攻螺絲 (T2.6x6mm) x 2

Use The Second hole
第二孔



Socket Button Head Screw
半圓頭內六角螺絲 (M2x6mm)



D48F Servo Horn
D48F 伺服器



DS455M Digital Servo
DS455M 數位伺服器

Optional Equipment
選購件

DS455M Digital Servo:

- 1.1520 μ s standard band / 1520 μ s 寬頻脈寬
- 2.9all torque / 輸出扭力: 2.2kg.cm (18.0V)
- 2.9kg.cm (18.0V)
- 3.Motion speed / 動作速度: 0.056sec/90° (18.0V)
- 0.048sec/90° (14.4V)
- 4.Dimension / 尺寸: 23 x 12 x 31.3mm
- 5.Weight / 重量: 25g



Linkage Ball A (M2x3.5)
球頭 A (M2x3.5) (ø 4.75x8.18mm)



M2 Nut
M2 螺帽



Socket Button Head Self Tapping Screw
半圓頭內六角自攻螺絲 (T2x6mm)



Socket Button Head Self Tapping Screw
半圓頭內六角自攻螺絲 (T2x6mm)



Tall Servo Mount
高伺服器固定座



Socket Button Head Self Tapping Screw
半圓頭內六角自攻螺絲 (T2.6x6mm) x 2



Socket Button Head Self Tapping Screw
半圓頭內六角自攻螺絲 (T2.6x6mm) x 2

470HB2



Socket Button Head Self Tapping Screw
半圓頭內六角自攻螺絲 (T2.6x6mm) x 2

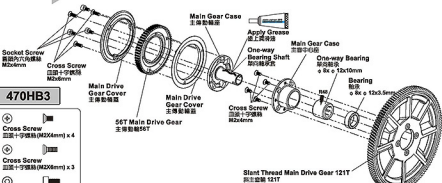

470HB3



Cross Screw
圓頭十字螺絲 (M2X4mm) x 4



Cross Screw
圓頭十字螺絲 (M2X6mm) x 3



Socket Screw
圓頭內六角螺絲 (M2x6mm) x 3

Main Gear Case
主傳動輪蓋



Apply Grease
塗上潤滑油



One-way Bearing Shaft
單向軸承殼

Main Gear Case
主傳動中心殼

One-way Bearing
單向軸承

ø 8 x 10x10mm

Bearing
軸承

ø 8 x 12x3.5mm

Cross Screw
圓頭十字螺絲 (M2x4mm)

Slant Thread Main Drive Gear 121T
斜齒主傳動齒 121T

470HB2



Socket Collar Screw

圓錐內六角鎖緊螺絲 (M2.5x12mm) x 1

470HZ1



470 Linkage Rod(A)
470 連桿 (A) (M2x15mm) x 3



Ball Link
連桿環 x 6

470HZ3

Please add a main shaft spacer if necessary.
如情況需要請加裝主軸墊片



Main Shaft Spacer(0.1)
主軸墊片 (0.1)
($\phi 6.1x \phi 9 x 6.1mm$)x1



Main Shaft Spacer(0.2)
主軸墊片 (0.2)
($\phi 6.1x \phi 9 x 6.2mm$)x2



Apply a small amount of T43 thread lock when fixing a metal part.
螺絲鎖附於金屬零件時使用微量 T43 (鎖絲膠)。



Original factory packages contains product already assembled, please confirm every screw is firmly secured with T43. Do not use T43 on any plastic part.

原廠零件出廠包裝如屬已組裝品，請再確認每顆螺絲是否鎖緊上膠。請注意 T43 不可塗在任何的塑膠材質上。

Optional Equipment
選裝品



While using Flybarless system, please use the swashplate leveler to calibrate swashplate. Adjust the length of servo linkage rod to make sure the swashplate is leveled before start setting up to ensure the gyro provides the best performance.

使用無平齒系統，請務必使用十字調整器校正十字架。調整伺服連桿長度，確保十字架達到水平狀態，再進行基本機體設定，這樣才能確保飛行性能達到最佳效果。

NEW
[H47H017XXW]
470 Main Shaft
470 主軸 $\phi 6x121mm$

470 Linkage Rod (A)
470 連桿 (A)

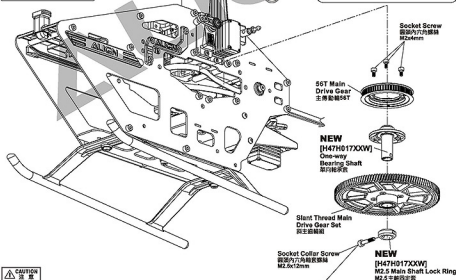

Socket Screw
圓錐內六角鎖緊螺絲
M2.5x4mm

56T Main Drive Gear
主傳動齒 56T

NEW
[H47H017XXW]
Omp-way Bearing Shaft
幫門軸承

Slant Thread Main Drive Gear Set
斜主軸齒組

Socket Collar Screw
圓錐內六角鎖緊螺絲
M2.5x12mm

NEW
[H47H017XXW]
M2.5 Main Shaft Lock Ring
M2.5 主軸固定套



Install the main shaft into the main drive gear after the belt has been installed, then align main shaft with the main shaft mounting sleeve, insert screw and tighten. DO NOT over tighten as this may cause damage of main shaft mounting sleeve.

請將相裝完成之主軸穿入已裝好皮帶的斜主軸齒組，穿入後對準主軸固定套上的孔位鎖附，並以適量扭力鎖附即可，過量鎖緊易造成主軸固定套滑牙。

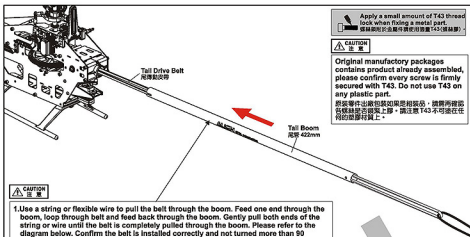

Apply a small amount of T43 thread lock when fixing a metal part.
螺絲架固定金屬件時使用微量T43(鎖螺絲)。

CAUTION
注意

Original manufactory packages contains product already assembled, please confirm every screw is firmly secured with T43. Do not use T43 on any plastic part.

原廠零件出廠包裝如果裝相預裝品，請再確認每顆螺絲是否緊上膠。請注意T43不可塗在任何的塑膠材質上。

CAUTION
注意

1. Use a string or flexible wire to pull the belt through the boom. Feed one end through the boom, loop through belt and feed back through the boom. Gently pull both ends of the string or wire until the belt is completely pulled through the boom. Please refer to the diagram below. Confirm the belt is installed correctly and not turned more than 90 degrees. Improper installation of the belt can result in serious damage to the helicopter or people.

2. When assembling the tail boom ensure the boom is properly installed in the tail boom mount and check to make sure belt is in the correct position.

1. 建議使用繩絲或線子拉緊皮帶的另一端將皮帶穿過尾管，皮帶組裝方向請依下方尾傳動皮帶裝配圖示安裝，確認皮帶組裝方向正確，否則將發生不可預期的危害。
2. 尾管組裝時必須確實鎖住尾管蓋正座，以確保皮帶調整位置正確。

DRIVE BELT ILLUSTRATION

尾傳動皮帶裝配圖示

Front
前



Tail belt must have a 90 degree counterclockwise turn from the front tail assembly to the rear tail assembly.

皮帶尾架組裝應逆時針90度旋轉。

WARNING
警告

DO NOT turn the belt greater than 90 degrees or the tail rotor system will fail.

皮帶組裝時須保持並行，嚴禁重疊交錯。



470HT2

Bearing
軸承 (φ 3x φ 8x3mm) x 2

Socket Button Head Screw
半圓頭內六角螺絲 (M2x5mm) x 4

Socket Button Head Screw
半圓頭內六角螺絲 (M2x12mm) x 1

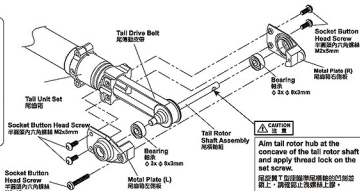

CAUTION
注意

Aim tail rotor hub at the concave of the tail rotor shaft and apply thread lock on the set screw.

尾槳轉丁型座應準尾槳軸的凹面並鎖上，請確認止鎖螺絲上膠。

Apply a small amount of T43 thread lock when fixing a metal part.
螺絲鎖用於金屬件鎖付時請用適量 T43 (螺絲鎖)。

CAUTION
注意

Original manufacturer packages contains product already assembled, please confirm every screw is firmly secured with T43. Do not use T43 on any plastic part.

原廠零件包裝如果已經組裝，請確認每顆螺絲都牢固鎖上。請注意 T43 不可用在任何的塑膠材質上。

470HT2

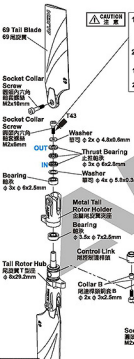

- 1. The Metal Tail Rotor Holder is assembled at the factory, make sure to apply little thread lock on screws and tighten them back appropriately before starting to fly. Suggest to use torque wrench or torque lock for tightening screws with the torque value 3.0kg.cm.**
- 2. Make sure to tighten the screws on each side with average strength, but no unilaterally tighter, or it may cause interference during rotation.**

1. 尾旋翼夾座出廠已經組裝，螺絲必須使用適量螺絲膠重新鎖付，鎖付時注意適量鎖緊即可，建議搭配扭力板扭力機鎖附，扭力值為 3.0kg.cm。
2. 組裝尾旋翼時，上、下螺絲必須平均力鎖緊附，不可單邊過緊，否則會造成干涉滑動不順暢。

CAUTION
注意

While assembly the slide shaft, please use suitable amount of T43 on the thread. Please do not use R48 or other high strength thread lock to avoid damages while maintenance or repairs.

組立尾輪滑蓋時，請使用適量的 T43 螺絲膠在螺絲上，嚴禁使用 R48 高強度合性螺絲膠防止膠合過緊，以避免日後換裝螺絲等件之損傷。

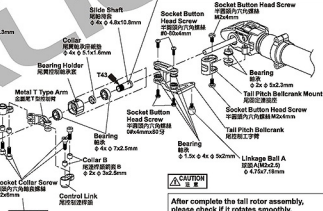

CAUTION
注意

After complete the tail rotor assembly, please check if it rotates smoothly.

尾旋翼組裝完成後請確認尾旋翼夾座轉動滑順。

CAUTION
注意

The tail rotor hub and screws are wear items, and thus should be inspected for replacement after every 100 flights. For flights with high head speed, the inspection interval should be reduced to ensure flight safety.

尾旋翼 T 型座和螺絲屬於飛行消耗品，建議每 100 次飛行檢查及更換，高主旋翼轉速飛行時，請縮短檢查之週數，以確保飛行安全。

CAUTION
注意

Any slight binding on control link may affect tail action during flight. Please be note while tightening M2x6mm socket collar screw, please adjust the ball link and make sure it is operating smoothly. Apply suitable amount of T43 on the thread.

尾旋翼控制桿鎖付干涉、動作不順暢，將影響尾旋翼定速效果，請注意鎖付 M2x6mm 帶鎖付六角軸套螺絲時，須調整尾旋翼球頭可順暢轉動的鬆緊，並使用適量 T43 螺絲膠鎖付。



470HT3



700N Linkage Rod(B)
700N 连杆(B) x 2



碳尾尾控制杆套
(ϕ 2.4x ϕ 5x10mm) x 2



Ball Link
连接销 x 2

470HT2



Washer
垫圈 (ϕ 2.6x ϕ 5.8x0.6mm) x 2



Socket Button Head Self
Tapping Screw
半圆颈内六角自攻螺丝
(T2.6x13mm) x 2



Socket Screw
圆颈内六角螺丝 (M2x18mm) x 2



Socket Button Head Self
Tapping Screw
半圆颈内六角自攻螺丝
(T2x16mm) x 2

Apply a small amount of T43 thread lock when fixing a metal part.
螺絲鎖附於金屬件時使用微量 T43 (鎖絲膠)。



Original manufactory packages contains product already assembled, please confirm every screw is firmly secured with T43. Do not use T43 on any plastic part.

原廠零件包裝包裏如果裝好產品, 請再確認每顆螺絲是否都緊上膠。請注意 T43 不可塗在任何的塑膠材質上。

When assembling the tail boom, please aim at the fixing hole ϕ 3.

此入尾管時請注意孔對準尾管 ϕ 3 固定孔。

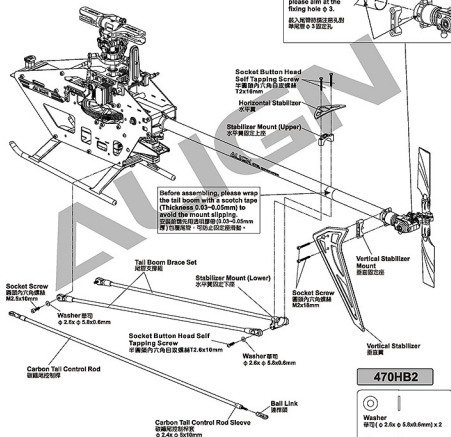
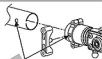

470HB2



Washer
垫圈 (ϕ 2.6x ϕ 5.8x0.6mm) x 2



Socket Screw
圆颈内六角螺丝 (M2.6x10mm) x 2

470HH1

Main Blade Fixing Screw

鎖緊旋翼用螺絲



Socket Collar Screw
鎖緊內六角旋翼螺絲 (M3x17mm) x 2



M3 Nut
M3 防鬆螺帽 x 2



Apply a small amount of T43 thread lock when fixing a metal part.
螺絲鎖附於金屬件請使用微量 T43 (鎖絲膠)。



CAUTION
注意
Original manufactory packages contains product already assembled, please confirm every screw is firmly secured with T43. Do not use T43 on any plastic part.

原廠零件包裝包裝如果已組裝品，請再確認每顆螺絲是否鎖緊上膠。請注意 T43 不可塗在任何的塑膠材質上。

Socket Collar Screw
鎖緊內六角旋翼螺絲
M3x17mm

When tightening the main blade fixing screw, please tighten it firmly, but not over tighten, or it may cause the damage of main blade holder and result in danger.

鎖緊旋翼螺絲時注意鎖緊力度即可，過緊可能導致旋翼夾座受損，飛行意外發生。

M3 Nut
M3 防鬆螺帽

360 Carbon Fiber Blades
360 碳纖維旋翼

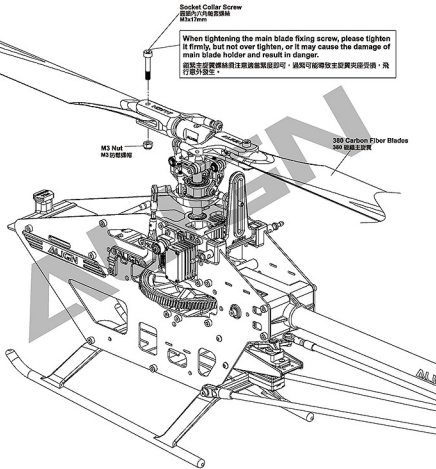

Apply a small amount of T43 thread lock when fixing a metal part.
螺絲鎖付金屬零件時請塗T43(鎖膠層)。

CAUTION
注意

Original manufactory packages contains product already assembled, please confirm every screw is firmly secured with T43. Do not use T43 on any plastic part.

原廠零件包裝包含產品已經裝好，請確認每顆螺絲是否都緊上膠。請注意 T43 不可塗在任何的塑膠材質上。



470HB2



Socket Screw 圓頭內六角螺絲 (M2.5x6mm) x 2

Motor Mount 馬達固定座
M3 Set Screw M3 止咬螺絲 M3x3mm

Socket Screw 圓頭內六角螺絲 (M2.5x6mm)

M4 Washer M4 墊圈 $\phi 2.6 \times \phi 5.8 \times 0.6 \text{mm}$

Motor Pinion Helical Gear 11T 馬達齒輪 11T

Motor 馬達

470HB2

Socket Screw 圓頭內六角螺絲 (M2.5x6mm) x 4

Washer 墊圈 ($\phi 2.6 \times \phi 5.8 \times 0.6 \text{mm}$) x 2

470HZ2

M3 Set Screw M3 止咬螺絲 (M3x3mm) x 1

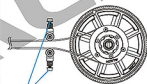
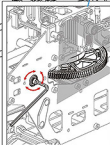
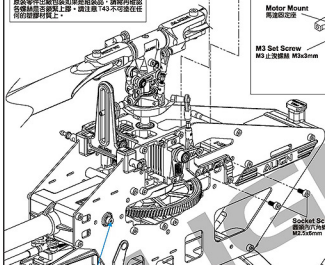

Used to adjust the belt tension by tightening or loosening the screw.
旋/放螺絲來調整皮帶鬆緊

BELT TENSION ADJUSTMENT SUGGESTION:

1. Adjust belt tension to ensure proper power transfer to the tail. To prevent excessive power consumption DO NOT over tighten belt.
2. Adjust both screws equally to tighten or loosen belt tension. Turn each screw approximately 1.5-2 turns to achieve the appropriate belt tension. Both sides must be rotated equally.
3. Make sure to check belt tension prior to each flight and adjust accordingly. To loosen belt tension, turn clockwise. To tighten belt tension, turn counterclockwise.

皮帶鬆緊調整建議：

1. 正確的調整皮帶鬆緊度，以確保飛行動力確實傳遞至尾部；皮帶不宜過緊，以免動力消耗。
2. 調整兩側皮帶鬆緊的調整螺絲時，兩名約 1.5-2 圈為最佳的皮帶鬆緊度。調整時務必向兩側的調整螺絲同時調整。
3. 每種飛行前，務必檢查調整螺絲的鬆緊度，順時針旋轉可將皮帶調整；逆時針旋轉則為皮帶鬆。

Set the motor pinion gear to main drive gear mesh to approximately 0.1mm to avoid excess power consumption motor burnt due to overload.

馬達齒輪可移動請保持兩齒輪咬合處約有 0.1mm 間隙，過緊齒輪咬合將造成動力損失或馬達高阻力的過載，嚴重可能導致馬達燒毀。

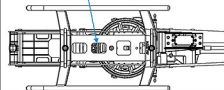

The lower edge of main gear need to be lined up with lower edge of pinion gear. This will ensure smooth meshing, and avoid interference between pinion's base and main gear which can lead to unusual wear.

馬達齒輪下緣必須與主齒輪下緣水平切齊，如此才能確保齒輪傳動順暢，避免馬達主齒輪與副齒輪主齒輪產生異常干涉磨損。





注意

A MOUNTING ORIENTATION OF MICROBEAST PLUS MICROBEAST PLUS的安裝方向



Please visit Align download area to get the completed instruction manual at Align website.

更多詳細的設定操作說明請至官網下載專區下載。
<http://www.align.com.tw/beastx/>

Microbeast PLUS provides 8 different direction choices can be installed on any position of helicopter.

Microbeast PLUS 提供8個不同方向選擇，可以安裝在機體的任何一個位置。

THE COLOR OF THE STATUS-LED SHOWS THE CURRENTLY SELECTED ORIENTATION:
 LED指示燈狀態顯示安裝方向：



Status LED Off
 Status-LED 燈熄滅*



Status LED Flashing Purple
 Status-LED 燈 紫色閃爍



Status LED Flashing Red
 Status-LED 燈 紅色閃爍



Status LED Flashing Red/Blue
 Status-LED 燈 紅色藍色同時閃爍



Status LED Red
 Status-LED 燈紅色



Status LED Flashing Blue
 Status-LED 燈藍色閃爍



Status LED Blue
 Status-LED 燈藍色



Status LED Flashing Red/Blue
 Status-LED 燈 紅色藍色同時閃爍

Front
 機頭方向

◆ Factory Setting

◆ 出廠預設值



Apply a small amount of T43 thread lock when fixing a metal part.
 螺絲鎖付金屬零件時使用適量 T43(鎖絲膠)。



注意

Original manufactory packages contains product already assembled, please confirm every screw is firmly secured with T43. Do not use T43 on any plastic part.

原廠零件包裝包如果裝好產品，請再確認每個螺絲是否都裝上膠。請注意 T43 不可塗在任何的塑膠材質上。

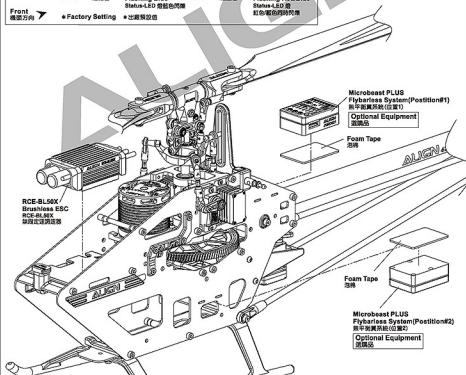

Compatible Battery/ 適用電池
6S 22.2V 1,400mAh to 1,900mAh.

Max battery size
可容納電池最大尺寸

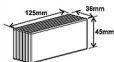

Slide the battery mounting plate along the rail until a "click" is heard to make sure the battery mounting plate is latched.
將電池固定板順著電池滑軌裝入至發出“嗒嗒”聲響，使電池固定板卡入卡槽。



While drawing out the battery, pull this latch to allow the battery to slide out along the rail.
電池拉出時，請先將拉扣往上拉順著滑軌抽出。

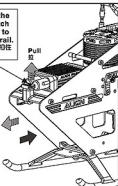
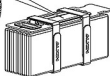

Please attach the hook & loop tape to narrow side of battery.
請將粘膠貼在電池的較窄面。

Battery Mount
電池固定板



Hook and Loop Tape
(Hooked)
黏毛面(勾狀)

Hook and Loop Tape
(Fuzzy)
黏毛面(絨毛狀)

Battery
電池



Use the included hook & loop strap to fix the battery in place. Start the strap 1cm below the battery mounting plate, go down along the battery until it wraps around completely. The end of the strap also needs to be 1 cm away from the battery mounting plate.
以附贈的黏毛束帶來固定電池，束帶需從電池板下方1公分處，沿電池由下往上方式纏，最後束帶末頭也要離電池板1公分。

以附贈的黏毛束帶來固定電池，束帶需從電池板下方1公分處，沿電池由下往上方式纏，最後束帶末頭也要離電池板1公分。



CANOPY ASSEMBLY

機頭罩安裝

ALIGN

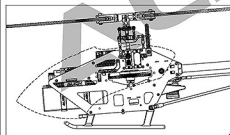

Canopy
機頭罩

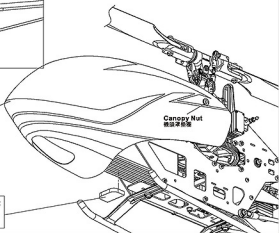

Canopy Nut
機頭罩鎖緊

Using the included foam tape on battery mount will effectively reduce vibration of canopy.
以隨附泡膠膠固定的電池座，能有效降低機頭罩震動。

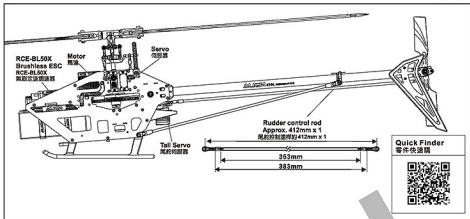

MICROBEAST PLUS FLYBARLESS MANUAL

無平衡翼系統使用說明

ALIGN

MICROBEAST PLUS Flybarless System as ALIGN helicopter standard equipment, must and compatible with ALIGN standard equipment including blades, servos, motor, battery and so on, please refer to flight and setup instruction in this manual.

ALIGN 直升機使用 MICROBEAST PLUS 無平衡翼系統，須搭配ALIGN 直升機標準配件(主旋翼、伺服器、馬達)與飛行操作、設定指示。

USER NOTICE 使用注意事項



- 1.If assembling and operating the helicopter without using ALIGN standard equipment, including electronic equipment & blades...etc, please make sure there is a sufficiently large and stable power supply to your helicopter. If there is any abnormal voltage or insufficient power supply, suggest to upgrade the flybarless system to MICROBEAST PLUS HD (Optional) for better power back up.
 - 2.Please refer to BEASTX MICROBEAST PLUS/HD website for MICROBEAST PLUS/HD assembly and setup instruction.
 - 3.Any over use, incorrect setup, missassembly, incorrect modification or misuse will lead to abnormal voltage, electronic devices damage, structural interference, and insufficient power supply. Make sure to carefully check every assembly and setup refer to the manual instruction prior to every flight to prevent any unforeseen danger.
1. 安裝、飛控型的直升機時，如非使用ALIGN 標準配件(含電子配件、主旋翼等)，請務必確定您的供電系統有足夠的供電能力，如發現電壓異常、供電不足，建議您升級使用 MICROBEAST PLUS HD 無平衡翼系統(選配)，以能確保充足、穩定的接收器電壓。
 2. MICROBEAST PLUS/HD 使用、設定、接線，請參照 BEASTX MICROBEAST PLUS/HD 官方說明。
 3. 任何電子配件、零件的設定、錯誤、修改或操作不良所造成的電壓異常、電子零件損壞，即可能造成供電不穩定等問題，每趟飛行前請注意仔細檢查，防止損壞及電子零件故障而引起不可預見的意外。

MANUAL LINK 設定操作連結

MICROBEAST PLUS Flybarless System is the latest version out of the factory, please feel at ease using it. You can also link to BEASTX MICROBEAST PLUS/HD website to get the latest version and the latest news. MICROBEAST PLUS Flybarless System has available some different versions, each version has different programming and function, please make sure your Microbeast version and read its correct manual carefully before assembly or upgrading, especially you are upgrade from version V3.2.X to V4.X.X by yourself, in order to avoid mistake or loss by any misunderstanding, please be sure that you have correct version and follow its setting method accordingly. And please refer to MICROBEAST PLUS V3.2.x and V4.2 instruction manual for operating and setting.

MICROBEAST PLUS 無平衡翼系統，出廠時主程序已是最新版本。您也可以連結至 BEASTX MICROBEAST PLUS/HD 官網查詢，隨時更新最新版本及各項最新訊息。部分版本因升級設定及功能會有所不同，請確定您的版本並詳讀其說明書，尤其您是由 V3.2.x 升級至 V4.x.x，請務必深入了解版本之間的設定功能，以免錯誤而造成損失。操作設定請同時參閱 V3.2.x 版及 V4.2 版使用說明書。



Please visit Align download area to get the completed instruction manual at Align website.

更多詳細的設定操作說明請至官網下載專區下載。
<http://www.align.com.tw/beastx/>



MICROBEAST PLUS
FLYBARLESS SYSTEM FOR HELICOPTER
Optional Equipment
選購品

PARTS IDENTIFICATION 各部位名稱

MICROBEAST PLUS FLYBARLESS SYSTEM 無平衡翼系統

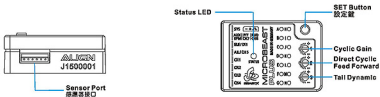

MICROBEAST PLUS FLYBARLESS SYSTEM WIRING DIAGRAM 無平衡翼系統接線示意圖

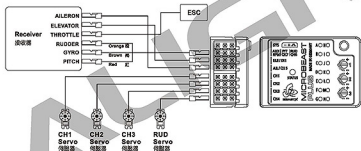

For detail connectivity, please scan QR Code then follow MICROBEAST PLUS manual.

詳細接線方式，請掃描QR Code並前往MICROBEAST PLUS說明書。



MICROBEAST PLUS HD Flybarless System(Optional) MICROBEAST PLUS HD無平衡翼系統(選配)

If assembling and operating the helicopter without using ALIGN standard equipment, including electronic equipment & blades...etc, please make sure there is a sufficiently large and stable power supply to your helicopter. If there is any abnormal voltage or insufficient power supply, suggest to upgrade the flybarless system to MICROBEAST PLUS HD (Optional) for better power back up. Please refer to BEASTX website for MICROBEAST PLUS HD assembly and setup instruction.

安裝、操作您的直昇機時，如非使用 ALIGN 標準配件(含電子配件、主旋翼等)，請務必確定您的供電系統有足夠的供電能力，如發現電壓異常、供電不足，建議即升級使用 MICROBEAST PLUS HD 無平衡翼系統(選配)，以能確保充足、穩定的接收器電源。MICROBEAST PLUS HD 使用、設定、接線，請參閱 MICROBEAST PLUS HD 官方說明。

To set this option is to turn on the transmitter and connect to BEC power.

Note: For the safety, please do not connect ESC to the brushless motor in order to prevent any accident caused by the motor running during the setting.

此項設定只須將發射器，接上BEC電源即可進行操作。

注意：為了安全起見，設定前請先不要將無刷調速器與無刷電機三線線接上，以免調整時啟動電機而發生危險。

SERVO CONFIGURATION 伺服器配置

Following the servo configuration diagram on right, plug the servos to Gyro.

請依照右圖顯示的伺服器名稱，將伺服器接到陀螺儀。

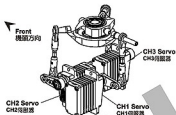

ADJUSTMENTS FOR GYRO AND TAIL NEUTRAL SETTING

陀螺儀與尾翼中立點設定調整

Turn off Revolution mixing (RVMX) mode on the transmitter, then set the gain switch on the transmitter and the gyro to non-head lock mode, or disable gain completely. After setting the transmitter, connect the helicopter power and proceed with rudder neutral point setting.

Note: When connecting to the helicopter power, please do not touch tail rudder stick and the helicopter, wait for 3 seconds for gyro to enable, and the rudder servo horn should be 90 degrees to the tail control pushrod. Tail pitch slider should be halfway on the tail output shaft. This will be the standard rudder neutral point. After completing this setting, set the gain switch back to heading lock mode, with gain at around 70%.

發射器內陀螺儀設定請關閉旋轉混疊模式，並將發射器上的感度開關與陀螺儀切至“非鎖定模式”或將陀螺儀感度關閉。發射器設定完成後接上直升機電源，即可進行舵中立點設置。

注意：當接上直升機電源時請勿觸動尾舵桿或極機槳，待3秒陀螺儀開機完成後，尾向舵桿需與尾向舵器約成90度，尾旋翼控制組須正確置於尾槳軸約中間位置，即為標準尾舵中立點設定，設定完成後，切換至“鎖定模式”，感度設約70%左右。

TAIL NEUTRAL SETTING 尾中立點設定

After the gyro is enable and under non-head lock mode, correct setting photo. If the tail pitch assembly is not in the middle position, please adjust the length of rudder control rod to trim.

陀螺儀開機後，在非鎖定模式下，尾向舵器與尾Pitch控制組正確擺置位置。

若尾Pitch控制組未置中時請調整尾控制桿桿的長度來修正。

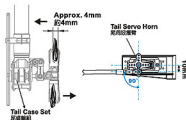

HEAD LOCK DIRECTION SETTING OF GYRO 陀螺儀鎖定方向設定

To check the head lock direction of gyro is to move the tail counterclockwise and the tail servo horn will be trimmed counterclockwise. If it trims in the reverse direction, please switch the gyro to "REVERSE".

陀螺儀鎖定方向確認，當手搖尾舵桿逆時鐘擺動，尾向舵桿應反時鐘修正，反方向時請切換陀螺儀上“鎖定反向”開關修正。

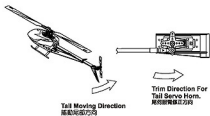



The rotational speed must set below 3,200RPM for safety to prevent any unexpected danger.

翼螺距的主翼翼有安全使用轉速範圍，飛行時不可超過3,200 RPM，超轉會導致不可預期的危險，甚至危害他人生命財產。

GENERAL FLIGHT 一般飛行模式

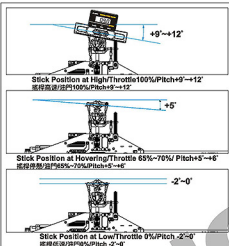

GENERAL FLIGHT 一般飛行模式

Throttle 油門	Pitch 螺距
5 100% High Speed 100% 高速	+9°~+12°
4 85%	
3 65%~70% Hovering 65%~70% 停滯	+5°
2 49%	
1 0% Low Speed 0% 低速	-2°~0°

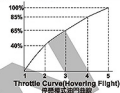

IDLE 1: SPORT FLIGHT

Throttle 油門	Pitch 螺距
5 80%	+12°
4 80%	
3 80%	+5°
2 80%	
1 80%	-5°

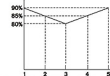

Throttle Curve (Simple Aerobatic Flight)
空中飛行模式油門曲線

IDLE 2: 3D FLIGHT

Throttle 油門	Pitch 螺距
5 90% High 90% 高	+12°
3 85% Middle 85% 中	0°
1 90% Low 90% 低	-12°

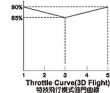

3D FLIGHT 3D特技飛行模式

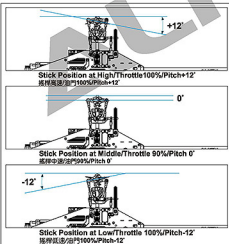

- Pitch range: Approx. 25 degrees.
- If the pitch is set too high, it will result in shorter flight duration and poor motor performance.
- Setting the throttle to provide a higher speed is preferable to increasing the pitch too high.

- 螺距 [Pitch] 總行程約 25
- 過大螺距設定，會導致動力與飛行時間降低。
- 動力提高以較高轉速的設定方式，優於螺距過大的設定。



While pitch set at 0 degree, make sure to set throttle below 85%.
螺距0度時，油門勿超過85%。

RCM-BL470MX (1800KV/2818) MOTOR RCM-BL470MX (1800KV/2818) 無刷馬達

This new Brushless motor developed by the ALIGN POWER R&D TEAM, is packed with the latest, cutting edge technology available today. It features exceptional levels of high-torque power. The 470MX utilizes an 8-pole outrunner stator-rotor and unrivaled Ndfeb extra strong magnets that traditional magnets cannot compare to. Also included is a high temperature, wear-resisting, low friction, double ZZ high efficiency bearing. The 470MX will be the most revolutionary motor operating on low current amperage, and delivering high torque to RC models.

由於把動力團隊獨家研發出新款的無刷馬達，具有超高扭力特色，採用 12 槽矽鋼片、8 個強力轉子以及傳統磁鐵無法比擬的強磁磁鐵磁鐵，搭配高速度耐用的雙 ZZ 最高效能精密軸承設計，電流低、扭力強，是這下一代革命中的最具代表性的一顆星。

SPECIFICATION 尺寸規格

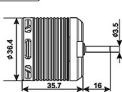

(Unit單位:mm)

KV	KV值	1800KV(RPM/V)	Input Voltage	輸入電壓	6S
Stator Diameter	定子外徑	28 mm	Stator Thickness	定子高度	18mm
Stator Arms	矽鋼片槽數	12	Magnet Poles	磁鐵極數	8
Max Continuous Current	最大持續電流	40A	Max Instantaneous Current	最大瞬間電流	60A(2sec)
Max Continuous Power	最大持續功率	890W	Max Instantaneous Power	最大瞬間功率	1300W(2sec)
Dimension	尺寸	Shaft ϕ 3.5x36.4x51.7mm	Weight	重量	Approx. 120g

RCE-BL50X BRUSHLESS SPEED CONTROLLER INSTRUCTION MANUAL

PRODUCT FEATURES 產品特色

- 5V~8.4V step-less adjustable BEC output allows custom voltage setting to match servo specification.
- BEC output utilizing switching power system, suitable for 7.4~22.2V (2S~6S) Li battery, with continuous current rating of 3A, and burst rating of 6A.
- Three programmable throttle speed settings to support quick throttle response.
- Include soft start and governor mode.
- Small and compact PCB design for lightweight and simple installation.
- Large heat sink for optimum thermal performance.
- Highly compatible to work with 98% of all brushless motors currently on the market.
- Ultra-smooth motor start designed to run with all kinds of brushless motors.
- The power inlet utilizes a Japanese made "Low ESR" capacitor in order to provide stable power source.
- The throttle has more than 200 step resolution that provides great throttle response and control.
- 5V~8.4V 無步可調式 BEC 輸出，可依伺服器規格與所需的特性自行設定電壓。
- BEC 輸入面採用交換式電源設計，適用 7.4~22.2V (2S~6S) 鋰電，持續電流 3A，瞬間 6A。
- 三段可程式化門反應速度，使動力的反應感更精確。
- 具備啟動及 Governor Mode 定速功能。
- 體積小、窄型設計，安裝於機身容易。
- 有散熱片設計，可延長電機壽命。
- 超寬相容性，可對應市面 98% 無刷馬達。
- 絕佳起步設計，無論國產、進口、內轉、外轉無刷馬達皆起步順暢。
- 電池電源採用日製 Low ESR 低阻抗電解電容，大幅提高電源之穩定性。
- 門門達 200 段以上解析度，最精確之門門感應。

SPECIFICATION 尺寸規格：

Model 型號	Continuous Current 持續	Peak Current 瞬間	BEC Output BEC輸出	Dimension 尺寸	Weight 重量
RCE-BL50X	50A	70A	Output voltage: 5~8.4V step-less adjustment Continuous current 3A; Burst current 6A 輸出電壓: 5V~8.4V 無步可調式 承受電流: 持續 3A、瞬間 6A	66x32x18.5mm	62g

WIRING ILLUSTRATION 接線示意圖

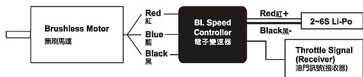

1. Good temperature situation for working at the maximum current
2. Supporting motor types: 2~10 pole → in/outrunner brushless motors.
3. Supporting maximum RPM: 2 pole → 190,000 rpm ; 6 pole → 63,000 rpm.
4. Input voltage: 7.4V ~ 22.2V(2~6S Li-Po)

NOTE : 1. When setting to the Quick throttle response speed, the accelerative peak current will increase.
2. To minimize possible radio interference induced by switching power system, BEC should be installed at least 5cm away from the receiver. The use of 2.4G receiver is recommended.

1. 持續最大電流會在機體發熱為最高情況下。
2. 支援馬達類型：二極至十極之內外轉子無刷馬達。
3. 支援最高轉速：二極 → 190,000rpm；六極 → 63,000rpm
4. 輸入電壓：7.4V-22.2V(2~6S Li-Po)

注意：1. 設定為高轉門反應速度時，加速瞬間電流會有增大情形。
2. 內建 Switching BEC，安裝時請與接收器保持至少 5cm 以內的距離(以避免干擾接收器(建議使用較穩定的 2.4G 系統接收器))。

FUNCTIONS 產品功能

1. Brake Option - 3 settings that include Brake disabled/Soft brake/Hard brake.
2. Electronic Timing Option - 3 settings that include Low timing/Mid timing/High timing. Generally, 2 pole motors are recommended to use low timing, while 6 or more poles should use Mid timing. High timing gives more power at the expense of efficiency. Always check the current draw after changing the timing in order to prevent overloading of battery.
3. Battery Protection Option- 2 settings that include Li-Ion, Li-poly High/Middle cutoff voltage protection. The default setting is high cutoff voltage protection. CPU will automatically determine cell number of input Lithium battery (2S~6S). This option will prevent over-discharge of the battery. The following reference is the guideline for setting the Battery Protection option.
3-1 Li-Ion/Li-poly High cutoff voltage protection-When the voltage of single cell drops to 3.2V, the first step of battery protection mode will be engaged by the ESC resulting in reduced power. The pilot should reduce the throttle and prepare landing. If the voltage of single cell drops to 3.0V, the second step of battery protection mode will be engaged resulting in power cutoff.
 (*Note 1) For 22.2V/6cells Lithium battery, the full charged voltage will be approximately 25.2V.
 According to this input voltage, CPU will determine that this is a 3cell battery.
 First step protection: 3.2V x 6cell=19.2V
 Second step protection: 3.0V x 6cell=18V
 When the voltage drops to 19.2V, the power will be reduced. When the voltage drops to 18V, the power will be cut off.
3-2 Li-Ion/Li-poly Middle cutoff voltage protection-This option is same as instruction 3-1, but when the voltage of single cell drops to 3.0V, the first step of battery protection will be engaged. When the voltage of single cell drops to 2.6V, the second step of battery protection will be engaged. (*Note 1)
 Note 1: Second step of battery protection only works when Aircraft mode is setting to the option 4-1.
 Note: this option is only suitable for a fully charged battery pack in good working condition.
4. Aircraft Option: 3 settings that include Normal Airplane / Helicopter 1 / Helicopter 2.
 Normal Airplane Mode is used for general airplanes and gliders. When flying Helicopters, you can choose Helicopter 1 Mode, or Helicopter 2 Mode. Helicopter 1 Mode provides Soft Start feature. Helicopter 2 Mode provides Soft Start and Governor Mode.
5. Throttle response speed: 3 settings that include standard/ Medium/ Quick throttle response speed.
 The default setting is "quick speed". Use this option to adjust the setting according to flight character. For example, setting at Medium or Quick speed for 3D and powerful flight to make the power response more quickly, but note the accelerative peak current and power expense will increase.
6. BEC output voltage setting: 5V~8.4V step-less adjustment.
 This option allows custom voltage setting. Default setting is 6.5V; please adjust the voltage according to the specification of the servo (speed and resistance). Prior to entering the setup mode, a voltmeter needs to be connected to the power inlet of the receiver (as illustration) to monitor the selected voltage. The voltage is set by varying the throttle stick position from low (5V) to high (8.4V).
7. Thermal Protection: When the ESC temperature reaches 80° C for any reason, it will engage the battery protection circuit, reducing power to the ESC. We recommend mounting the ESC in a location with adequate air flow and ventilation.
8. Safe Power On Alarm: When the operator turns on the ESC, it will automatically detect the transmitter signal. The ESC will emit a confirmation tone and enter normal operation mode if the throttle is set to the lowest position. If the throttle position is at full throttle, it will begin to enter Setup Mode. If the throttle is in any other position, the ESC will emit an alarm and not enter into user mode for safety precautions.
9. Aircraft Locator: If the aircraft should land or crash in an unexpected location and become lost, the pilot can enable the Aircraft Locator Option. The aircraft locator option is engaged by turning off the transmitter. When the ESC does not receive a signal from the transmitter for 30 seconds, it will start to send an alarm to the motor. The sound of the alarm will aid the pilot to locate the aircraft. This option will not work with a PCM receiver that has SAVE function enabled, or with low noise resistant PPM receivers.

1. 簡單設定：三段選擇分為無煞車 / 軟性煞車 / 急煞車
2. 齒角設定：三段選擇分為低齒角 / 中齒角 / 高齒角
 設定時分為二極以及六極以上無刷馬達，二極無刷馬達一般適用低齒角，若若齒角過高轉速提高，可將齒角設定為中齒角。六極以上無刷馬達一般適用中齒角，若若齒角過高轉速提高，可將齒角設定為高齒角。然而齒角之調整會反應電流之變化，避免電流過載，影響電機及馬達壽命。
3. 電池保護電壓設定：二段選擇分為 Li-Ion / Li-Po 高截止電壓保護/中截止電壓保護
 出廠設定為高截止電壓保護；此功能會自動判定所輸入電池的cell數(2~6S)，並提供使用者對電池之放電保護，以避免因放電電壓過低而造成電池損壞，以下為設定之解說：
3-1 Li-Ion/Li-Po 高截止電壓保護：當單電壓cell電壓降至3.2V時，電壓會啟動第一階段保護，使動力隨軟性中斷，此時使用者應將油門收小，準備降落；而cell電壓持續降臨至3.0V時則會啟動第二階段保護，完全限制動力輸出(僅1倍在4-1選擇「一般飛機模式」下才會啟動第二階段保護)。例：以一個設定用22.2V 6cell 的電池之系統而言22.2V 單電池充滿電壓約25.2V，此輸入電壓CPU會自動判定為6cell 6極電。

第一階段保護: 3.2V & cell = 19.2V

第二階段保護: 3.0V & cell = 18V 當電壓降至 19.2V 時，動力會暫時性中斷，當電壓降至 18V 時則完全關閉動力輸出。

3-2 Li-Ion/Li-Po 中斷充電保護：同時 3 功能都關閉，但當電池電壓達到 3.0V 時，會啟動第一階段保護，當電池電壓達到 2.8V 時則啟動第二階段保護(註1)。注意：以上功能僅適用於充電器，且功能正常的設備。

4. 飛機模式設定：三段式選擇分為：一般飛機模式/直昇機模式/直昇機模式 2

適用於一般飛機或滑翔機時，請設定於一般飛機模式，使用於直昇機時可選擇直昇機模式 1；具有緩啟動功能。或直昇機模式 2：具有緩啟動及 Governor Mode 設定功能。

5. 油門反應速度設定：三段選擇分為標準/中速/快速

此項設定為“快速”油門反應選擇，此功能可供使用者選擇飛行特種作業所需的設定，例如 3D 飛機與劇烈的 3D 直昇機飛行時可設定為中速或快速，使動力反應更迅速。警告：必須在靜態油門反應速度時，調整調整電流與電池電量會有增大的情形。

6. BEC 輸出電壓設定: 5V - 8.4V 無段調整：

本功能提供使用者自行設定 BEC 輸出電壓，初始電壓為 6.5V，使用者可依所駕駛的規格與所需的特性(速度與扭力)自行更改設定；進入此項設定前，請先將電壓表連接到接收器的電壓端(如圖 1)，用以監看所選擇的電壓，設定時以油門搖桿的位置來決定輸出電壓，油門搖桿最低為 5 伏特，最高為 8.4 伏特，之間的電壓值可移動搖桿的位置任意設定。

7. 溫度保護：當電壓因不良之空氣流通或過度輸出導致溫度上升達 80°C 時，電壓會啟動溫度保護，而使動力瞬間性中斷，建議將電壓裝置在機艙內空氣對流之位置，並確保使用電流表測量輸出電流，以達到電壓之最優效率。

8. 閉鎖防暴衝功能：當使用者關閉電壓電路時，系統會自動偵測發動機之設定，如果發動機油門未處於最低點，系統會於發動機準備進入設定模式，馬達將不會轉動，同時會有警報聲響。

9. 警報功能：當飛機降落在長草區無法以肉眼定位時，使用者可將發動機閉鎖，當電壓無法接收來自接收機信號時，電壓會於三十秒後使馬達發出警報聲響，以別定位。此功能不適用於設定了 SAVE 功能的 PCM 接收機，或任何新版的 PPM 接收機。

The voltmeter needs to be connected to any un-cored leads "4" and "5" to measure the selected voltage.
將電壓表連接到任一未使用導線的“4”及“5”端，以量測所選擇的電壓。

RCE-BL56X Brushless ESC
RCE-6L48X 有刷直流電動機



NOTE: Certain servos are designed to work with high voltage, while other servos are designed for lower voltage. To avoid damage to servos, please follow the servo's factory specification to determine the proper voltage setting.
注意：部份伺服器不適合較高的電壓下操作，請依原廠適用電壓規格設定，避免造成伺服器損壞。

SETUP MODE 設定模式

1. Setup mode: Make sure to connect the ESC to the throttle channel of the receiver. Please refer to the user manual of your radio system. The second step is to connect the 3 power-out signal pins to the brushless motor. Before you turn on the transmitter, please adjust the throttle stick to the maximum full throttle position. Proceed to connect the battery to the ESC. You will hear confirmation sounds as soon as you enter the SETUP MODE.

2. Throttle stick positions in Setup mode: Setup mode includes six settings: Brakes, Electronic Timing, Battery Protection, Aircraft, Throttle Response Speed and BEC output voltage. Every setting has three options. Simply place the throttle stick in the highest, middle, and lowest positions for each setting. For example, first brake setting (Hard): move the stick to the highest position. Then timing setting (mid): move the throttle stick in the middle position.

1. 進入設定模式：將電壓與接收器之油門 Channel 連接，不同之遙控系統請參閱遙控系統之使用手冊，馬達之三相線亦與電壓連接，將遙控器之油門搖桿推到最高點，使之於全油門狀態，先將電壓與接收器連接，再將電壓連接至馬達，進入設定模式後，馬達將有設定模式之提示聲響，請參閱各式設定模式說明。
2. 設定模式中動作：設定模式共有六項設定，分別為煞車、電子定時、電池保護、飛機模式、油門反應速度及 BEC 輸出電壓等設定，詳細內容請參考產品功能之解說，每一項設定中皆含三段設定，各項設定以油門搖桿之上、中、下位置來決定其設定值。例如：煞車設定時，油門搖桿移至最高，則設定為煞車，進入第二項設定時，油門搖桿移至中間，則設定為中速角。

Mode 設定模式	Throttle Position 油門位置	Low 低	Middle 中	High 高
Brake 煞車設定		● Brake Disabled(1-1) 煞車禁用(1-1)	Soft Brake(1-2) 軟性煞車(1-2)	Hard Brake(1-3) 硬性煞車(1-2)
Electronic Timing 電子定時		Low-timing(2-1) 低定時角(2-1)	● Mid-timing(2-2) 中定時角(2-2)	High-timing(2-3) 高定時角(2-3)
Battery Protection 電池保護電壓設定		● High Cutoff Voltage Protector(3-1) 高截止電壓保護(3-1)	Middle Cutoff Voltage Protector(3-2) 中截止電壓保護(3-2)	—
Aircraft 飛機模式設定		Normal Airplane/Glider(4-1) 一般飛機/滑翔機(4-1)	● Helicopter 1 (Soft Start)(4-2) 直昇機模式 1 (緩啟動)(4-2)	Helicopter 2 (Soft Start+ Governor Mode)(4-3) 直昇機模式 2 (緩啟動+Governor Mode 設定)(4-3)
Throttle Response Speed 油門反應速度設定 (3 段選擇)		Standard(5-1) 標準 (5-1)(低)	Medium Speed(5-2) 中速 (5-2)(中)	● Quick Speed(5-3) 快速 (5-3)(高)
BEC Output Voltage BEC 輸出電壓設定		5.0V	● 6.5V	8.4V

Note: "●" Default Setting
註：“●” 表示預設設定值

Chart A
表 A

ESC START-UP INSTRUCTION 開機使用模式

Ensure the throttle stick is at the lowest position.
Switch on transmitter.
打開電壓，油門搖桿保持於最低點，準備進入使用操作模式



Connect battery power to ESC
將電池接上電壓，馬達發出警報



Current Settings Indicator Beeps
并空使用模式設定警報

- First mode sound (Brake)
 - Second mode sound (Timing)
 - Third mode sound (Battery protection)
 - Fourth mode sound (Aircraft)
 - Fifth mode sound (Throttle response speed)
 - No sound for BEC output voltage
- 第一音響模式設定(煞車)
第二音響模式設定(電子定時)
第三音響模式設定(電池保護)
第四音響模式設定(飛機模式)
第五音響模式設定(油門反應速度)
BEC 輸出電壓無音響提示

CURRENT SETTINGS INDICATOR BEEPS EXPLANATION 開機模式設定響音提示說明

First Beep Group Brake Status
第一組響音 煞車設定狀態提示

- ♪ = Brake disabled = 煞車禁用
- ♪♪ = Soft brake = 輕煞車
- ♪♪♪ = Hard brake = 重煞車

Second Beep Group Electronic Throttle
第二組響音 電子油门設定提示

- ♪ Low timing = 低油门設定(油門行程短)
- ♪♪ Mid timing = 中油门設定(油門行程中)
- ♪♪♪ High timing = 高油门設定(油門行程長)

High-torque/High power/over current
高扭力/高功率/過電流保護

Third Beep Group Battery protection Cutoff
第三組響音 電池保護截止狀態提示

- ♪ = High cutoff voltage protection = 高截止電壓保護
- ♪♪ = Middle cutoff voltage protection = 中截止電壓保護

Fourth Beep Group Aircraft Status
第四組響音 飛機模式設定狀態提示

- ♪ = Normal airplane/Glider = 一般飛機/滑翔機
- ♪♪ = Helicopter 1 (soft start) = 直升機1(軟起飛)
- ♪♪♪ = Helicopter 2 (soft start + Governor Mode) = 直升機2(軟起飛+定速模式)

Fifth Beep Group Throttle Response
第五組響音 油门響應設定狀態提示

- ♪ = Standard = 標準
- ♪♪ = Medium speed = 中速
- ♪♪♪ = Quick speed = 快速

INSTRUCTIONS ON AIRCRAFT MODE SETTINGS 飛機模式設定使用說明

Normal Airplane/Glider Mode (Option 4-1): This option is applied to general airplanes and gliders.

Helicopter 1 Mode (Option 4-2): This option provides a soft start feature and is applied to Helicopters for Normal, Idle Up 1, or Idle Up 2 modes. Please note that the sensitivity of the gyro should be set lower when flying in Idle Up 1 or Idle Up 2 modes if tail hunting (wag) occurs due to higher rotor speed.

一般飛機模式(選項4-1): 適用於一般飛機及滑翔機。

直升機模式1(選項4-2): 具有輕啟動功能, 適用於Normal、Idle1、Idle2等飛行模式。當切換至Idle1或Idle2模式, 如有較高轉速造成陀螺儀有較慢的追蹤現象, 此時應將陀螺儀的感度設定分別降低。

HELICOPTER 2 MODE (OPTION 4-3): GOVERNOR MODE 直升機模式2(選項4-3): 定速模式

The soft start-up feature allow to fix RPM at assigned level during 3D flight for better flight performance.

- For Governor Mode, the throttle curve should set between 75%-85%. The motor will start up when the throttle reaches to 50% or more. The instruction diagram shown as below:
- If the governor mode cannot fix the throttle amount at assigned level during flight, it allows to increase the gain value in option 5 Governor Gain Setting. If there is tracking which means it is too sensitive, please adjust the gain lower to fix it.
- If the tail happens to be tracking slightly, please adjust the GYRO gain lower. Under such conditions: wrong gear ratio combination, poor battery, incorrect GYRO gain setup, and wrong Pitch input, all of them will affect the governor mode and result in drift issue. So please make sure to double re-check the other settings for Governor Mode setup.

定速模式具有緩啟動, 於特種飛行模式下轉速較為穩定, 有較好的飛行性能。

- 選擇定速功能時, 油门曲線應設定於75%-85%之間, 油门大於90%定速功能才會開啟, 油门曲線設定如下:
- 當飛行時, 定速效果不好, 無法維持在設定油门曲線時, 可以調高定速感度值, 定速感度對於選項5油门反應感度-定速感度的設定, 如果出現轉速追蹤現象, 表示定速感度過高再需要調低感度。
- 如果飛行時發現尾部有輕微的追蹤現象時, 應降低陀螺儀的感度; 由於轉速不穩定(齒比搭配不當), 電池效能不佳, 陀螺儀感度設定不當, Pitch設定錯誤, 皆會導致定速追蹤的功能, 甚至產生尾部偏擺的情形, 所以選擇此模式時應對相關條件進行確認。

Governor Function
Throttle Settings Instruction
定速模式油门曲線設定圖

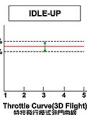
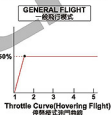

SETUP MODE 程式化設定模式

Minimum 4 channel radio is required 四通以上標準發射器均可執行設定

<p>Place the throttle stick to the highest position. Switch on transmitter. 將油门杆移动到最高位置, 打开发射器。</p> <p>1</p>	<p>Connect battery to ESC 將電池連上電機, 高電壓指示</p> <p>2</p>	<p>ESC will automatically calibrate the throttle high position. Sound confirms acceptance. 電機將自動校準油门杆的高位置, 音效確認接受。</p> <p>3</p>	<p>Place the throttle stick to the lowest position. Sound confirms acceptance. 將油门杆移动到最低位置, 音效確認接受。</p> <p>4</p>	<p>Use throttle stick to set preferred Brake Mode within the 5 tones. A confirmation sound will play acknowledging acceptance of selected setting. 使用油门杆設定偏好的煞車模式, 在5個音階內。音效確認接受。</p> <p>5</p>
<p>Use throttle stick to set preferred Timing Mode within the 5 tones. (Refer to Chart A) A confirmation sound will play acknowledging acceptance of selected setting. 使用油门杆設定偏好的齒比模式, 在5個音階內。請參閱圖表A。音效確認接受。</p> <p>6</p>	<p>Use throttle stick to set preferred Battery Protection Mode within the 5 tones. (Refer to Chart A) A confirmation sound will play acknowledging acceptance of selected setting. 使用油门杆設定偏好的電池保護模式, 在5個音階內。請參閱圖表A。音效確認接受。</p> <p>7</p>	<p>Use throttle stick to set preferred Aircraft Mode within the 5 tones. (Refer to Chart A) A confirmation sound will play acknowledging acceptance of selected setting. 使用油门杆設定偏好的飛機模式, 在5個音階內。請參閱圖表A。音效確認接受。</p> <p>8</p>	<p>Use throttle stick to set preferred Throttle Response Speed Mode within the 5 tones. (Refer to Chart A) A confirmation sound will play acknowledging acceptance of selected setting. 使用油门杆設定偏好的油门響應速度模式, 在5個音階內。請參閱圖表A。音效確認接受。</p> <p>9</p>	<p>Use throttle stick to set preferred ESC Output Voltage Mode within 5 tones. (Refer to Chart A) A confirmation sound will play acknowledging acceptance of selected setting. 使用油门杆設定偏好的ESC輸出電壓模式, 在5個音階內。請參閱圖表A。音效確認接受。</p> <p>10</p>

PLEASE PRACTICE SIMULATION FLIGHT BEFORE REAL FLYING 飛行前請事先熟練電腦模擬飛行

A safe and effective practice method is to use the transmitter flying on the computer through simulator software sold on the market. Do a simulation flight until you familiarize your fingers with the movements of the rudders, and keep practicing until the fingers move naturally.

- Place the helicopter in a clear open field (Make sure the power OFF) and the tail of helicopter point to yourself.
- Practice to operate the throttle stick (as below illustration) and repeat practicing "Throttle high/low", "Aileron left/right", "Rudder left/right", and "Elevator up/down".
- The simulation flight practice is very important, please keep practicing until the fingers move naturally when you hear operation orders being call out.

在還沒瞭解直升機各動作的操作方式前，請先在電腦飛行，請先進行電腦模擬飛行的練習，一樣要有效、最安全的練習方式，就是透過市面販售的模擬軟體，以遙控器在電腦上模擬飛行，熟悉各個方向的操控，並不斷的重複，直到手指可熟練的控制各個動作及方向。

- 將直升機放在空曠的地方(確定電源為關閉)，並將直升機的機尾對準自己。
- 練習操作遙控器的各搖桿(各動作的操作方式如下圖)，並反覆練習油门高低、副翼左/右、升降舵前後及方向的左/右操作方式。
- 模擬飛行的練習相當重要，請重複練習直到不需思索，手指能自然隨著喊出的指令移動控制。



Mode 1	Mode 2	Illustration 圖示	
		Move Left 左移 Rotate Left 左轉	Move Right 右移 Rotate Right 右轉
		Fly Forward 前進 Forward Rotate 前轉	Fly Backward 後退 Backward Rotate 後轉
		Ascent 上升 ↑ Descent 下降 ↓	
		Turn Right 右轉 Turn Left 左轉	

FLIGHT ADJUSTMENT AND NOTICE 飛行調整與注意



- Check if the screws are firmly tightened.
- Check if the transmitter and receivers are fully charged.
- 再次確認螺絲是否鎖緊?
- 查詢遙控器接收器電池是否足電。



If there are other radio control aircraft at the field, make sure to check their frequencies and tell them what frequency you are using. Frequency interference can cause your model, or other models to crash and increase the risk of danger. 假使飛行場有其他遙控飛機，請確認他們的頻率，並告知他們您正在使用的頻率，相同的頻率會造成干擾導致失控和大大地增加風險。

STARTING AND STOPPING THE MOTOR 啟動和停止馬達



First check to make sure no one else is operating on the same frequency. Then place the throttle stick at lowest position and turn on the transmitter.

首先確認附近沒有其他相同頻率的，然後打開發射器將油门搖桿推到最低。

- Check the movement.
- 動作確認



ONI Step1
First turn on the transmitter.
先開發射器

ONI Step2
Connect to the helicopter power
接上面飛機電源



Check if the throttle stick is set at the lowest position.

確認油门搖桿是在最低的位置。



- Are the rudders moving according to the controls?
- Are the transmitter's instruction manual to do a range test.
- 方向舵是否隨著控制方向移動?
- 根據發射器說明書進行距離測試。

OFF! Step3
Reverse the above orders to turn off.
隨機電源時請以上述操作動作反執行。

This procedure is best performed on soft surfaces such as grass. The use of rubber skid stopper is recommended on hard surface to prevent vibration feedback from the ground to Gyro, resulting in over-corrections.

將直升機置於柔軟地面上，建議使用起飛腳架裝上避震墊圈。避免升空前腳架與硬的地面震動太大反映至機身上的陀螺儀，影響無平衡系統升空前過度修正。



If swashplate should tilt prior to lift off, do not try to manually trim the swashplate level. This is due to vibration feedback to the Gyro, and will disappear once helicopter lifts off the ground. If manual trim is applied, helicopter will tilt immediately after liftoff.

直升機離地前，十字盤可能會因陀螺儀震動的反應，使十字盤有傾斜的情形，此請勿刻意將十字盤修正為水平狀態，此現象只要離地升空時立即解除，可平穩升空；若刻意將十字盤修正為水平時，反而會造成感應器過度修正，一離地即會在修正方向的危險。

MAIN ROTOR ADJUSTMENTS 主旋翼雙槳平衡調整

1. Before adjusting, apply a red piece of tape on one blade, or paint a red stripe with a marker or paint to identify on blade.
2. Raise the throttle stick slowly and stop just before the helicopter lifts-off ground. Look at the spinning blades from the side of the helicopter.
3. Look at the path of the rotor carefully. If the two blades rotate in the same path, it does not need to adjustment. If one blade is higher or lower than the other blade, adjust the tracking immediately.

1. 調整前先在其中一支主旋翼的槳面，貼上有顏色的貼紙或畫上顏色記號，方便雙槳調整辨識。
2. 慢慢將起飛桿提升到離地並停止，在飛機離地前，從側面觀察雙槳主旋翼轉動。
3. 仔細觀察如雙槳軌跡(如兩支旋翼移動都是相同軌跡，則不需調整；可是如果一支旋翼較高或較低產生“雙槳”的情形時，則必須立刻調整軌跡)。

- a. When rotating, the blade with higher path means the pitch is too big. Please shorten ball link for regular trim.
- b. When rotating, the blade with lower path means the pitch is too small. Please lengthen ball link for regular trim.

- a. 旋翼轉動時較高軌跡的主旋翼表示傾角(PITCH)過大，請調短球桿修正。
- b. 旋翼轉動時較低軌跡的主旋翼表示傾角(PITCH)過小，請調長球桿修正。



Tracking adjustment is very dangerous, so please keep away from the helicopter at a distance of at least 10m.

調整軌跡非常危險，請於距離飛機至少10公尺的距離。

Incorrect tracking may cause vibrations. Please repeat adjusting the tracking to make sure the rotor is correctly aligned. After tracking adjustment, please check the pitch angle is approx. $+5^{\circ}$ ~ -6° when hovering.

不正確的旋翼軌跡會導致震動，請不斷重複調整軌跡，使旋翼軌跡精準正確。

在調整軌跡後，確認一下Pitch角度在停空時應為大約 $+5^{\circ}$ ~ -6° 。

Color Mark 有標示記號的主旋翼

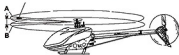

FLIGHT ADJUSTMENT AND NOTICE 飛行調整與注意



Ⓞ Do not attempt to grab or make contact with the helicopter while the main blades are in motion and keep your eyes away from the helicopter. During take-off, landing, and flight, be sure to keep the helicopter away from all obstacles. Operators must stand at least 10 meters away from the helicopter to avoid injury caused by loose parts due to improper assembly or any unforeseen dangers.

Ⓞ 嚴禁用手抓取運行中的直升機，並禁止將直升機對準眼睛，當主旋翼轉動後，或起飛/試飛時，務必遠離障礙物，站立位置必需距離10公尺以上，避免因人為組裝不當造成零件脫落，而引起不可預期的財物及人員損傷。



Ⓞ Make sure that no one or obstructions in the vicinity.

Ⓞ For flying safety, please carefully check if every movement and directions are correct when hovering.

Ⓞ 確認鄰近地區沒有人和障礙物。

Ⓞ 為了飛行安全，您必須先確認停機時各項操控動作是否正確。



Do not attempt to fly until you have some experiences with the operation of helicopter.

嚴禁無熟練操作經驗者操縱飛行。

STEP 1 THROTTLE CONTROL PRACTICE 油門控制練習

- ⓐ When the helicopter begins to lift-off the ground, slowly reduce the throttle to bring the helicopter back down. Keep practicing this action until you control the throttle smoothly.

ⓐ 當直昇機開始離地時，慢慢降低油門將飛機降下，持續練習飛機從地面上升和下降直到您覺得油門控制很順。



STEP 2 AILERON AND ELEVATOR CONTROL PRACTICE 副翼和升降控制練習

1. Raise the throttle stick slowly.
2. Move the helicopter in any direction back, forward, left and right, slowly move the aileron and elevator sticks in the opposite direction to fly back to its original position.

1. 慢慢升起油門桿。
2. 使直昇機依指示：移動向後/向前/向左/向右，慢慢的反向移動副翼和升降桿並將直昇機歸回原來位置。



ⓐ If the nose of the helicopter moves, please lower the throttle stick and land the helicopter. Then move your position diagonally behind the helicopter 10M and continue practicing.

ⓑ If the helicopter flies too far away from you, please land the helicopter and move your position behind 10M and continue practicing.

ⓐ 當直昇機傾倒偏移時，請降低油門並且降落，然後移動自己的位置到直昇機的正後方 10 公尺再繼續練習。

ⓑ 假如直昇機飛離你太遠，請先降落直昇機，並到直昇機後 10 公尺再繼續練習。

STEP 3 RUDDER CONTROL PRACTICING 方向舵操作練習

1. Slowly raise the throttle stick.
2. Move the nose of the helicopter to right or left, and then slowly move the rudder stick in the opposite direction to fly back to its original position.

1. 慢慢升起油門桿。
2. 將直昇機機頭移動左或右，然後慢慢反向移動方向舵桿並將直昇機飛回原本位置。



STEP 4

After you are familiar with all actions from STEP1 to 3, draw a circle on the ground and practice within the circle to increase your accuracy.

當你覺得 STEP1-3 動作熟悉了，在地上畫圈並在這個範圍的範圍內練習飛行，以增加你操控的準確度。

- ⓐ You can draw a smaller circle when you get more familiar with the actions.
ⓑ 當你更加習慣操作動作，你可以畫更小的圈。



STEP 5 DIRECTION CHANGE AND HOVERING PRACTICE 改變直昇機方向和練習停旋

After you are familiar with STEP1 to 4, stand at side of the helicopter and continue practicing STEP1 to 4. Then repeat the STEP1 to 4 by standing right in front of the helicopter.

當你覺得STEP1-4動作熟悉了，站在面對直昇機側邊並繼續練習STEP1-4。之後，站在直昇機機頭正邊重複步驟練習。



	Problem 狀況	Cause 原因	Solution 對策
Blade Tracking 雙槳平衡	Tracking is Off 雙槳	Pitch linkage rods are not even length PITCH連桿長度調整不平衡	Adjust length of ball link. 調整連桿球長度
Hover 停懸	Head speed too low 主旋翼轉速偏低	Excessive pitch 主旋翼的PITCH過高	Adjust ball link to reduce pitch by 4 to 5 degrees. 調整連桿球角度Pitch約-4-5度
		Hovering throttle curve is too low 停懸點油门曲線過低	Increase throttle curve at hovering point on transmitter (around 60%) 調高停懸點油门曲線(約60%)
	Head speed too high 主旋翼轉速偏高	Not enough pitch 主旋翼的PITCH過低	Adjust ball link to increase pitch by 4 to 5 degrees. 調整連桿球角度Pitch約+4-5度
		Hovering throttle curve is too high 停懸點油门曲線過高	Decrease throttle curve at hovering point on transmitter (around 60%) 調低停懸點油门曲線(約60%)
Rudder Response 尾舵反應	Drifting of tail occurs during hovering, or delay of rudder response when centering rudder stick. 停懸時機翼向某一邊偏航，或停懸時方向舵空回游到中立點時，尾翼產生反應，橫滾停懸在所欲方位上。	Rudder neutral point improperly set 尾中立點設定不準	Reset rudder neutral point 重設尾中立點
	Tail oscillates (hunting, or wags) at hover or full throttle 停懸或全油门時尾翼左右來回搖擺。	Rudder gyro gain too low 尾舵陀螺儀感度偏低	Increase rudder gyro gain 增加尾舵陀螺儀感度
		Rudder gyro gain too high 尾舵陀螺儀感度偏高	Reduce rudder gyro gain 降低尾舵陀螺儀感度

If above solution does not resolve your issues, please check with experienced pilots or contact your Align dealer.

※在做完以上調整後，仍然無法改善情況時，應立即停止飛行並向有經驗的飛手諮詢或連絡您的經銷商。

Thank you for purchasing and supporting ALIGN products.

The Align Team is dedicated to you by innovating and developing new RC Helicopters, Multicopters, and FPV Racing Quads. We strive to provide a more diversified experience for our customers. Visit our website at www.align.com.tw for latest news, information, and updates about our extensive line of products for the RC enthusiasts.

Good Flying!

再次感謝您對亞拓系列商品的喜愛與支持，您的肯定是對我們最大的認同。

亞拓團隊秉持創新研發的精神，開發遙控直昇機／多軸飛行機／穿越機系列商品，提供給您體驗更多樣化的飛行樂趣。您可以透過下列連結，隨時瞭解亞拓的最新動態，以及各項訊息分享。

祝福您有一個愉快的飛行體驗。



ALIGN Flight Safety 亞拓飛行安全宣導

<http://www.align.com.tw/flysafe-en/>



ALIGN T-REX Helicopter 亞拓遙控直昇機

<http://www.align.com.tw/helicopter-en/>



ALIGN Multicopter 亞拓多軸飛行機

<http://www.align.com.tw/multicopter-en/>



ALIGN FPV Racing Quad 亞拓穿越機

<http://www.align.com.tw/multicopter-en/mr25/>



ALIGN Website 亞拓官網

<http://www.align.com.tw>



ALIGN Shopping Cart 亞拓購物車

<http://shop.align.com.tw/index.php?language=en>



ALIGN Quick Finder 亞拓零件快速購

<http://shop.align.com.tw/partfinder.php?language=en>



ALIGN FaceBook

<https://www.facebook.com/Align-Corporation-194493419543/?ref=mf>



ALIGN Instagram

<https://instagram.com/aligncorporation/>



ALIGN YouTube

https://www.youtube.com/channel/UCaPj_K5DNo7HSmP1eyUvMQ



ALIGN Youku

<http://i.youku.com/u/UMTQ0NjEwNjc2Ng==>

ALIGN

ALIGN

Specifications & Equipment/規格配備:

Length/機身長:755mm

Height/機身高:210mm

Main Blade Length/主旋翼尺寸:380mm

Tail Blade Length/尾旋翼尺寸:69mm

Main Rotor Diameter/主旋翼直徑:850mm

Tail Rotor Diameter/尾旋翼直徑:181mm

Motor Pinion Gear/馬達齒輪:11T

Main Drive Gear/傳動主齒輪:121T

Autorotation Tail Drive Gear/尾傳動主齒:56T

Tail Drive Gear/尾翼傳動齒:15T

Drive Gear Ratio/齒輪傳動比:11:1:3.73

Flying Weight(without battery)/全配重(不含電池): Approx. 860g

