

T15

ALIGN

INSTRUCTION MANUAL

使用說明書

RH15E21XW

RH15E26XW

RH15E31XW

FLIP IT!
DUAL Direct Drive
BRUSHLESS MOTORS
雙直驅無刷馬達



compatible with



A10
2.4GHz 10 Channel
Radio Control System



The Instruction Manual is suitable for the T15 series of products. For specification information, please refer to the content in this manual.

此說明書適用T15系列商品，規格內容請詳閱說明書。

Thank you for purchasing Align products. Please read this manual carefully before installing, and retain the manual for future reference. All pictures shown are for illustration purposes only. The actual product may vary due to product enhancement. Specifications, contents, parts, and availability are subject to change. ALIGN RC is not responsible for inadvertent errors in this publication.

承蒙閣下選用亞拓遙控世界系列產品，謹表謝意。使用前，請務必詳閱本說明書，相信一定能夠給您帶來相當大的幫助，也請您妥善保管這本說明書，以做為日後參考。本公司將不對此印刷物之異動負責，也無法主動通知消費者任何更新或異動。所有圖片僅用於展示目的。產品可能因改良而有些不同。本說明書內記載的材質、規格或零件包裝之內容物如有異動，請依亞拓官網公告為主。

INTRODUCTION 前言.....	1	POWER COLLOCATION REFERENCE 原裝動力數據參考表.....	31
SAFETY NOTES 安全注意事項.....	2	T15G FLYBARLESS PREFLIGHT CHECK 飛行前測試程序.....	33
T15 FEATURES T15 產品特色介紹.....	5	FLIGHT ADJUSTMENT AND SETTING 飛行動作調整與設定.....	35
PACKAGE ILLUSTRATION 包裝說明.....	5	T15GA FLYBARLESS FLIGHT TEST PROCEDURE 飛行測試程序.....	39
MODEL STANDARD EQUIPMENT DIFFERENCE 標準配備版本說明.....	6	TROUBLESHOOTING 飛行中狀況排除.....	38
SAFETY CHECK BEFORE FLYING 飛行前安全檢查重要事項.....	7		
ASSEMBLY SECTION 組裝說明.....	8		
SERVO INSTALLATION AND ADJUSTMENT 伺服器組裝與調整.....	11		
INSTALLATION FOR BATTERY 電池安裝方式.....	13		
CANOPY ASSEMBLY 機頭罩安裝.....	13		
EQUIPMENT ILLUSTRATION 設備配置圖示.....	14		
PITCH AND THROTTLE SETTING 主旋翼螺距與油門設定.....	15		
T15GA FLYBARLESS MANUAL T15GA 無平衡翼系統使用說明.....	16		
T15GA SOFTWARE INSTALLATION AND SETUP T15GA 安裝與設定.....	17		
FLIGHT MODE INTRODUCTION 飛行模式介紹.....	28		
A10 TRANSMITTER FEATURE INSTRUCTION A10 遙控器產品特色介紹.....	30		

The T15 Helicopter is designed as an easy-to-use, full-featured R/C Helicopter model capable of all forms of rotary flight. Before operating the model, please read the manual carefully and follow all the manual precautions and recommendations. Be sure to retain the manual for future reference, routine maintenance, and tuning. The T15 is a new product developed by ALIGN. It features the best design available on the R/C helicopter market to date, providing flying stability for beginners, full aerobatic capability for advanced fliers, and unsurpassed reliability for customer support.

感謝您選購亞拓產品，為了讓您容易方便的使用 T15 直昇機，請您詳細的閱讀完這本說明書之後再進行組裝以及操作這台直昇機，同時請您妥善的保存這本說明書，作為日後進行調整以及維修的參考。T15 是由亞拓自行研發的新產品，不論您是需求飛行穩定性的初學者或是追求性能的飛行愛好者，T15 將是您最佳的選擇。

WARNING LABEL LEGEND 標誌代表涵義



Do not attempt under any circumstances.
在任何禁止的環境下，請勿嘗試操作。



Mishandling due to failure to follow these instructions may result in damage or injury.
因為疏忽這些操作說明，而使用錯誤可能造成財產損失或嚴重傷害。



Mishandling due to failure to follow these instructions may result in danger.
因為疏忽這些操作說明，而使用錯誤可能造成危險。

IMPORTANT NOTES 重要聲明

R/C helicopters, including the T15 are not toys. R/C helicopter utilize various high-tech products and technologies to provide superior performance. Improper use of this product can result in serious injury or even death. Please read this manual carefully before using and make sure to be conscious of your own personal safety and the safety of others and your environment when operating all ALIGN products. Manufacturer and seller assume no liability for the operation or the use of this product. This product is intended for use only by adults with experience flying remote control helicopters at a legal flying field. After the sale of this product we cannot maintain any control over its operation or usage.

As the user of this product, you are solely responsible for operating it in a manner that does not endanger yourself and others or result in damage to the product or the property of others.

T15遙控直昇機並非玩具，它是結合了許多高科技產品所設計出來的休閒用品，所以商品的使用不當或不熟悉都可能會造成嚴重傷害甚至死亡，使用之前請務必詳讀本說明書，勿輕忽並注意自身安全。注意！任何遙控直昇機的使用，製造商和經銷商是無法對使用者於零件使用的損耗異常或組裝不當所發生之意外負任何責任，本產品是提供給有操作過模型直昇機經驗的成人或有相當技術的人員在旁指導於當地合法遙控飛行場飛行，以確保安全順暢下操作使用，產品售出後本公司將不負任何操作和使用控制上的任何性能與安全責任。

作為本產品的使用者，您是唯一對於您自己操作的環境及行為負全部的責任之人。

We recommend that you obtain the assistance of an experienced pilot before attempting to fly our products for the first time. A local expert is the best way to properly assemble, setup, and fly your model for the first time. The T15 requires a certain degree of skill to operate, and is a consumer item. Any damage or dissatisfaction as a result of accidents or modifications are not covered by any warrantee and cannot be returned for repair or replacement. Please contact our distributors for free technical consultation and parts at discounted rates when you experience problems during operation or maintenance. As Align Corporation Limited has no control over use, setup, final assembly, modification or misuse, no liability shall be assumed nor accepted for any resulting damage or injury. By the act of use, setup or assembly, the user accepts all resulting liability.

模型商品屬於高操作技術且為消耗性之商品，如經拆裝使用後，會造成不等情況零件損耗，任何使用情況所造成商品不良或不滿意，將無法於保固條件內更換新品或退貨，如遇有使用操作維修問題，本公司全省分公司或代理人將提供技術指導、特價零件供應服務，對使用者的不當使用、設定、組裝、修改、或操作不良所造成的破損或傷害，本公司無法控制及負責。任何使用、設定、組裝、修改、或操作不良所造成的破損、意外或傷害，使用者應承擔全部責任。



- Fly only in safe areas, away from other people. Do not operate R/C aircraft within the vicinity of homes or crowds of people. R/C aircraft are prone to accidents, failures, and crashes due to a variety of reasons including, lack of maintenance, pilot error, and radio interference. Pilots are responsible for their actions and damage or injury occurring during the operation or as a result of R/C aircraft models.
- Prior to every flight, carefully check rotorhead spindle shaft screws and tail blade grip screws, linkage balls and screws, ensure they are firmly secured.
- 遙控模型飛機、直昇機屬高危險性商品，飛行時務必遠離人群，人為組裝不當或機件損壞、電子控制設備不良，以及操控上的不熟悉，都有可能導致飛行失控損傷等不可預期的意外，請飛行者務必注意飛行安全，並需了解自負疏忽所造成任何意外之責任。
- 每趟飛行前須仔細檢查，主旋翼夾座橫軸螺絲、尾旋翼夾座螺絲，以及機身各部位球頭、螺絲，確實上鎖鎖緊才能升空飛行。



LOCATE AN APPROPRIATE LOCATION 遠離障礙物及人群

R/C helicopters fly at high speed, thus posing a certain degree of potential danger. Choose a legal flying field consisting of flat, smooth ground without obstacles. Do not fly near buildings, high voltage cables, or trees to ensure the safety of yourself, others and your model. For the first practice, please choose a legal flying field.

Do not fly your model in inclement weather, such as rain, wind, snow or darkness.

直昇機飛行時具有一定的速度，相對的也潛在著危險性，場地的選擇也相對的重要，請遵守當地法規到合法遙控飛行場地飛行，務必選擇在空曠合法專屬飛行場地，並必須注意周邊有沒有人、高樓、建築物、高壓電線、樹木等等，避免操控的不當造成自己與他人財產的損壞，請勿在下雨、打雷等惡劣天氣下操作，以確保本身及機體的安全。



NOTE ON LITHIUM POLYMER BATTERIES 鋰聚電池注意事項

Lithium Polymer batteries are significantly more volatile than alkaline or Ni-Cd / Ni-MH batteries used in RC applications. All manufacturer's instructions and warnings must be followed closely. Mishandling of Li-Po batteries can result in fire. Always follow the manufacturer's instructions when disposing of Lithium Polymer batteries.

鋰聚電池跟一般在RC使用的鹼性電池、鎳鎘電池、鎳鎳電池比較起來是相對危險的，請嚴格遵守鋰聚電池說明書之使用注意事項，不恰當使用鋰聚電池，可能造成火災並傷及生命財產安全，切勿大意！



PREVENT MOISTURE 遠離潮濕環境

R/C models are composed of many precision electrical components. It is critical to keep the model and associated equipment away from moisture and other contaminants. The introduction or exposure to water or moisture in any form can cause the model to malfunction resulting in loss of use, or a crash. Do not operate or expose to rain or moisture.

直昇機內部也是由許多精密的電子零組件組成，所以必須絕對的防止潮濕或水氣，避免在浴室或雨天時使用，防止水氣進入機身內部而導致機件及電子零件故障而引發不可預期的意外！



PROPER OPERATION 勿不當使用本產品

Please use the replacement of parts on the manual to ensure the safety of instructors. This product is for R/C model, so do not use for other purpose.

請勿自行改造加工，任何的升級改裝或維修，請使用亞拓產品目錄中的零件，以確保結構的安全，請確認於產品限內操作，請勿過載使用，並勿用於安全、法令外其它非法用途。



**OBTAIN THE ASSISTANCE OF AN EXPERIENCED PILOT 避免獨自操控**

Due to the certain learning curve when operating RC helicopters for the first time, avoid attempts by yourself. The guidance provided by an experienced pilot will be invaluable for the assembly, tuning, trimming, and actual first flight or unforeseen danger may happen. (Recommend you to practice with computer-based flight simulator.)



遙控直昇機操控技巧在學習初期有著一定的難度，要盡量避免獨自操作飛行，需有經驗的人士在旁指導，才可以操控飛行，否則將可能造成不可預期的意外發生。(動練電腦模擬器及老手指導是入門必要的選擇)

**SAFE OPERATION 安全操作**

Make sure to always be aware to keep your eyes and body away from blades rotation. Do not attempt to grab or make contact with the helicopter while the main blades are in motion. During take-off, landing, and flight, be sure to keep the helicopter away from all obstacles. Operators must stand at least 5 meters away from the helicopter. Never take your eyes off the model or leave it unattended while it is turned on, and immediately turn off the model and transmitter when you have landed the model. Operate this unit within your ability, do not fly under tired condition, improper operation may cause in danger, and always to avoid injury caused by loose parts due to improper assembly or any unforeseen dangers.



請隨時注意，無論在任何時候，都不能將運轉中的旋翼對著眼睛，嚴禁用手抓取運行中的直昇機，當主旋翼轉動後，或起飛/試飛時，務必遠離飛機，站立位置必需距離5公尺以上，不可在視線範圍外進行飛行，降落後也請馬上關掉直昇機和遙控器電源。操作這台直昇機需要一定操控技術及能力，避免因人為組裝不當造成零件脫落，而引發不可預期的財物及人員損傷，並請衡量自身情況，過於疲勞、精神不佳或不當操作，都可能引發不可預期的意外發生。

**ALWAYS BE AWARE OF THE ROTATING BLADES 遠離運轉中零件**

During the operation of the helicopter, the main rotor and tail rotor will be spinning at a high rate of speed. The blades are capable of inflicting serious bodily injury and damage to the environment. Be conscious of your actions, and careful to keep your face, eyes, hands, and loose clothing away from the blades. Always fly the model a safe distance from yourself and others, as well as surrounding objects.



直昇機主旋翼與尾旋翼運轉時會以高轉速下進行，在高轉速下的旋翼會造成自己與他人在身體上或環境上的嚴重損傷，請勿觸摸運轉中的主旋翼與尾旋翼，並保持安全距離以避免造成危險及損壞。

**KEEP AWAY FROM HEAT 遠離熱源**

R/C models are made of various forms of plastic. Plastic is very susceptible to damage or deformation due to extreme heat and cold climate. Make sure not to store the model near any source of heat such as an oven, or heater. It is best to store the model indoors, in a climate-controlled, room temperature environment.



遙控飛機、直昇機多半是以 Pa 纖維或聚乙烯、電子商品為主要材質，因此要盡量遠離熱源、日曬，以避免因高溫而變形甚至爆炸損壞的可能。

SAFETY ON THE USE OF DRY CELL BATTERIES 乾電池使用安全

The AA carbon-zinc batteries are one time use, they should not be charged for repetitive use. Please read and follow the guidelines below prior to use. The manufacturer cannot be held liable for accidents and damages as result of improper usage.

- These are one time use battery, and should not be recharged.
- Ensure proper polarity and installation method during use.
- Do not mix battery of different age or different model. Doing so may affect battery life, and even cause fire danger.
- If the product is not used for long period of time, please remove the batteries to prevent damaged caused by battery leaks. Do not use batteries which exhibits symptoms of leaks.
- Please follow local law and ordinances when disposing used batteries. Do not dispose them improperly.

3號(AA)碳鋅電池，不可重覆充電使用，使用碳鋅電池前請務必詳讀並遵照下列事項，本公司將不對任何不當使用所造成的損害及意外負責。

- 碳鋅電池為一次性電池，嚴禁重覆充電使用。
- 安裝使用時，請確認電池正負極位置及安裝方式。
- 嚴禁新舊或不同型號電池混用，以免影響電池使用壽命，甚至造成電池起火燃燒的危險。
- 產品長期不使用時，請取出電池，以免造成電池電力流失或電池滲液而損壞主機。若電池已經有滲液情況，請勿再繼續使用。
- 廢棄電池，請依照該使用國家或地區的廢棄物清理法令回收，切勿任意丟棄以免污染環境。



Battery leakage
電池滲液

SAFETY ON THE USE OF LITHIUM POLYMER (LIPO) BATTERIES 鋰聚電池使用安全

Lithium batteries have higher degree of risk when compared to other batteries. Please read and follow the guidelines below prior to use. The manufacturer cannot be held liable for accidents and damages as result of improper usage.

- Due to the certain learning curve when operating RC helicopters for the first time, avoid attempts by yourself. The guidance provided by an experienced pilot will be invaluable for the assembly, tuning, trimming, and actual first flight or unforeseen danger may happen. (Recommend you to practice with computer-based flight simulator.)
- Avoid over charging / discharging Li-Po batteries. Doing so may cause internal damages and affect the battery's discharge performance.
- Avoid continuous use under high temperature environment, or when battery exhibits high temperature. Doing so may shorten battery life, causing puffing of battery, or even danger of explosion.
- Discharge the batteries to 60-70% of full capacity for long term storage. Too low of voltage may result in over-discharging over time. Therefore, we recommend periodic charge of battery in long term storage, this will reduce chance of over-discharge damage.
- To avoid the danger of explosion and fire, use of third party charger to charge these batteries are prohibited.
- Avoid impact, disassembly, incorrect polarity, and burning of batteries. Avoid shorting of battery terminal by metallic objects. Avoid puncture of battery with sharp material.
- Charging error could result in battery explosion, fire, and other unexpected danger or property loss. Please always charge batteries with equipment in sight, do not leave charger unattended. Should you need to leave the charging area, please remove the battery and abort charging process.
- Should the battery exhibit excessive heat after use, do not charge immediately. Doing so may cause battery to puff, deform, explode, or even start a fire.
- Please follow local law and ordinances when disposing used batteries. Do not dispose them improperly.



鋰聚電池較其他電池有更高的危險性，使用前請務必遵照下列注意事項，本公司將不對任何不當使用所造成的損害負責。

- 充電時請使用原廠鋰聚電池充電器，充電電壓8.4V(4.2V/CELL)電流不可高於0.6A，放電時不得低於最低放電電壓3V/CELL。
- 避免電池要避過充與過放的情形發生，過充或過放會對電池內部造成損傷並影響電池放電性能。
- 避免在高溫的環境或電池已經產生高溫而繼續使用，這會使電池壽命減短，嚴重者可能會使電池膨脹甚至爆炸的危險。
- 如果長期不用時，請以60%~70%的充電量儲存。電量過低時，可能因自放電導致過放，因此，存放不使用的備用電池時，建議定期充電，以防止自放電導致小工作電壓而老化，避免電池充飽存放，充飽存放可能會導致電池的膨脹。
- 嚴禁使用原廠以外的充電器進行充電，以免發生爆炸起火危險。
- 嚴禁強擊、折斷、正負極反接、夾傷電池，避免金屬物品接觸電池正負極造成短路，並請防止尖銳物刺穿電池，以免引起電池起火危險。
- 充電時務必在視線範圍內進行，不可在無人看管的情形下充電，以免因自放電導致過放造成電池膨脹、氣體甚至引發火災等不可預料的危險及損失。若異常時請將電池取出，停止對電池充電。
- 電池使用後如有發熱情況，嚴禁充電，否則會造成電池膨脹、變形、爆炸甚至起火燃燒，危害生命財產的安全。
- 廢棄電池，請依照該使用國家或地區的廢棄物清理法令回收，切勿任意丟棄以免污染環境。

BLAST AND DYNAMIC DIRECT-DRIVE, DUAL-BRUSHLESS MOTORS!

Innovative and powerful, the Align T15 utilizes new direct-drive performance motors; it's lighter, stronger, quieter, and has a simpler design. The flight controller allows customizable flight parameters with the ability to quickly switch to three different internal flight modes: attitude stabilization, sport 3D, or extreme 3D. You can choose to use the ALIGN A10 transmitter and the built-in receiver A-BUS. Optionally a Spektrum DSM2/DSMX, or JR DSM/DSMX satellite receiver with a compatible transmitter may be used, and you are ready to fly. The T15 incorporates brand-new high-rigidity, efficient carbon fiber composite blades. The sturdy T15 main frame adopts high-strength nylon composite fiber material, which is cold-resistant and impact-resistant, bringing a new dynamic experience. Fly anywhere, fly anytime, with the mighty T15!

高爆發力直驅動力，雙無刷馬達！

創新且強大的 ALIGN T15 採用新型直驅動力高性能馬達，更輕、更堅固、更安靜，設計更簡單。飛行控制器允許自訂飛行參數，能夠切換三種不同的飛行模式：姿態穩定、運動 3D 或極限 3D。您可以選擇使用 ALIGN A10 發射器和內建接收器 A-BUS、或 Futaba S-FHSS 2.4Hz 系統；或者自備 SPEKTRUM DSM2/DSMX、JR DSM/DSMX 衛星接收器，完成遙控器設定及對頻就可以起飛了。高剛性主翼碳纖維複合材，讓控制更靈活精準，動力爆發源源不絕，堅固 T15 機身採用高強度尼龍複合纖維材料，與耐衝擊特性，可隨時隨地，隨心所欲！

Compatible with



PACKAGE ILLUSTRATION

包裝說明

ALIGN

Already Assembled
已組裝

T15 Kit x 1 set
T15 空機零件組 x 1 組

- BL15M(1500KV/2405) Main Motor x 1
BL15M(1500KV/2405) 主馬達 x 1
- BL15MT(8000KV/1103) Tail Motor x 1
BL15MT(8000KV/1103) 尾馬達 x 1
- T15 Digital Servo x 2
T15 數位伺服器 x 2
- T15T Digital Servo x 1
T15T 數位伺服器 x 1

Optional Equipment
選購品

- T15G Flybarless System(S.BUS)x 1
T15G 扁平平衡系統組(S.BUS) x 1
- T15GA Flybarless System(A.BUS)x 1
T15GA 扁平平衡系統組(A.BUS) x 1

Optional Equipment
選購品

- T15 Painted Canopy-Blue
T15 彩繪機頭罩-藍
- T15 Painted Canopy-Yellow
T15 彩繪機頭罩-黃

7.4V 400mAh Li-Po Battery x 1
Li-Po 電池 x 1

Hexagon ScrewDriver Set
六角螺絲起子組
1.3mm x1+0.9mm x1

T15 Main Blades x 1 Set
T15 主翼片 x 1 組

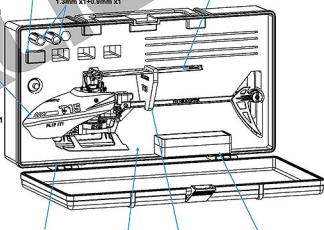

T15 Carry Box x 1
T15 手提箱 x 1

Foam Case
泡棉架

Main Blade Holder
主翼固定架 x 1

Parts Box E
配件盒 E
Spare Parts Pack
備件包

Optional Equipment
選購品

A10 Radio Control System
A10 遙控器 x 1 組

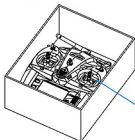

There are several versions of T15. Some versions include additional electronics and other equipment. The Instruction Manual is based on the T15 RTF. You may purchase additional items or spare parts for different T15 TA versions by referring to more product information in this manual.

T15系列商品有多種版本可作為選擇，除標準配備會因您購買的商品版本而有差異不同，在組裝、設定上都是一致的，在此我們以T15 TA作為操作範例，您也可以依照書面上的商品與列表來選購其他選購商品。

Part Quick Finder
零件快速碼



T15 COMBO STANDARD EQUIPMENT			T15 套裝版標準配備	[RH15E21XT]
<p>T15 Kit T15G Flybarless System(S.BUS) T15G 俯平衡翼系統(S.BUS)</p> 			<p>① Hexagon ScrewDriver Set 六角螺絲起子 1.3mm / 0.9mm L型六角扳手 1.5mm / 1.3mm</p> <p>② Feathering Shaft Wrench 2.5 槓軸拆卸扳手 x1</p> <p>③ Main Blade Holder 主旋翼固定架 x1</p> <p>④ T22 Thread Lock T22 螺絲膠 1cc x1</p> <p>⑤ Remote Extension 遙控器訊線</p> <p>⑥ Blade Balance Decal 主旋翼配置貼紙</p> <p>⑦ Parts Box/Spare Parts Pack 配件盒/備件包</p> 	
<p>T15 Carry Box-Black T15 專用手提箱 x1</p> 	<p>T15 Tail Blade T15 尾旋翼 x1</p> 	<p>7.4V 400mAh Li-Po Battery 7.4V 400mAh Li-Po 電池 x1</p>  		

T15 A COMBO STANDARD EQUIPMENT			T15 A 套裝版標準配備	[RH15E26XT]
<p>T15 Kit T15GA Flybarless System(A.BUS) T15GA 俯平衡翼系統(A.BUS)</p> 			<p>① Hexagon ScrewDriver Set 六角螺絲起子 1.3mm / 0.9mm L型六角扳手 1.5mm / 1.3mm</p> <p>② Feathering Shaft Wrench 2.5 槓軸拆卸扳手 x1</p> <p>③ Main Blade Holder 主旋翼固定架 x1</p> <p>④ T22 Thread Lock T22 螺絲膠 1cc x1</p> <p>⑤ Remote Extension 遙控器訊線</p> <p>⑥ Blade Balance Decal 主旋翼配置貼紙</p> <p>⑦ Parts Box/Spare Parts Pack 配件盒/備件包</p> 	
<p>T15 Carry Box-Black T15 專用手提箱 x1</p> 	<p>T15 Tail Blade T15 尾旋翼 x1</p> 	<p>7.4V 400mAh Li-Po Battery 7.4V 400mAh Li-Po 電池 x1</p>  		

T15 TA COMBO STANDARD EQUIPMENT			T15 TA 套裝版標準配備	[RH15E31XT]
<p>T15 Kit T15GA Flybarless System(A.BUS) T15GA 俯平衡翼系統(A.BUS)</p> 			<p>① Hexagon ScrewDriver Set 六角螺絲起子 1.3mm / 0.9mm L型六角扳手 1.5mm / 1.3mm</p> <p>② Feathering Shaft Wrench 2.5 槓軸拆卸扳手 x1</p> <p>③ Main Blade Holder 主旋翼固定架 x1</p> <p>④ T22 Thread Lock T22 螺絲膠 1cc x1</p> <p>⑤ Remote Extension 遙控器訊線</p> <p>⑥ Blade Balance Decal 主旋翼配置貼紙</p> <p>⑦ Parts Box/Spare Parts Pack 配件盒/備件包</p> 	
<p>T15 Carry Box-Black T15 專用手提箱 x1</p> 	<p>T15 Tail Blade T15 尾旋翼 x1</p> 	<p>A10 Radio Control System A10 遙控器 x1</p>  		

CAREFULLY INSPECT BEFORE REAL FLIGHT 請嚴格執行飛行前檢查義務

- Before flight, please check if the batteries of transmitter and receiver are enough for the flight.
- Before turn on the transmitter, please check if the throttle stick is in the lowest position. IDLE switch is OFF.
- When turn off the unit, please follow the power on/off procedure. Power ON- Please turn on the transmitter first, and then turn on receiver. Power OFF- Please turn off the receiver first and then turn off the transmitter. Improper procedure may cause out of control, so please to have this correct habit.
- Before operation, check every movement is smooth and directions are correct. Carefully inspect servos for interference and broken gear.
- Check for missing or loose screws and nuts. See if there is any cracked and incomplete assembly of parts. Carefully check main rotor blades and rotor holders. Broken and premature failures of parts possibly cause a dangerous situation.
- Check all ball links to avoid excess play and replace as needed. Failure to do so will result in poor flight stability.
- Check if the battery and power plug are fastened. Vibration and violent flight may cause the plug loose and result in out of control.

每次飛行前請定時檢查射擊器與接收器電池的電量是在足夠飛行的狀態。

開機前請確認油门桿是否位於最低點，熄火油路開關。定速開關(IDLE)是否於關閉位置。

開機時必須遵守電源開機程序，開機時應先開接收器後，再開射擊器電源；開機時應先開接收器後，再開開射擊器電源。不正確的開機程序可能會造成失控的現象，影響自身與他人的安全。請養成正確的习惯。

開機前請先確定真昇機各個動作是否正確，及方向是否正確，並檢查伺服器的動作是否有干涉或阻塞的情形。使用故障的伺服器等等致不可預期的危險。

飛行前檢查沒有缺少或鬆動的螺絲與螺帽，確認沒有組裝不完整或損壞的零件，仔細檢查主旋翼夾座是否有損壞，特別是最近主旋翼夾座的部位。損壞或組裝不完整的零件不僅影響飛行，更會造成不可預期的危險。注意：每次飛行前的安全檢查、保養、及更換損耗零件，請認真嚴格執行以確保安全。

檢查所有的連接頭是否有鬆動的現象，過鬆的連接頭應先更新，否則將造成真昇機無法操控的危險。

確認電池及電源插頭是否固定牢靠，飛行中的震動或激烈的飛行，可能造成電源接觸鬆動而造成失控的危險。

When you see the marks as below, please use relative glue or grease to ensure flying safety.

標有以下內容的組裝步驟，請配合上膠或上油，以確保關節等件使用之可靠性。

• R48 : Apply small amount of Anaerobic Retainer to fix.
螺絲膠：使用適量螺絲膠固定

• CA : Apply small amount of CA Glue to fix.
快乾膠：使用適量快乾膠固定

• T43 : Apply small amount of Thread Lock to fix.
螺絲膠：使用適量螺絲膠

• OIL : Add small amount of OIL.
潤滑油：添加適量潤滑油

• T22 : Apply small amount of Thread Lock to fix.
螺絲膠：使用適量螺絲膠

• Grease : Add small amount of Grease.
潤滑膏：添加適量潤滑膏

When assembling ball links, make sure the "A" character faces outside.

各關節膠製選擇頭扣螺絲時，"A"字朝外。



Keep plastic parts away from heat.
塑膠零件避免接近熱源。

Optional Equipment
選購品



Anaerobic Retainer
快乾膠



Thread Lock
螺絲膠



Thread Lock
螺絲膠



CA Glue
快乾膠



Grease
潤滑膏



Oil
潤滑油



T43 Glue width : approx. 1mm
T43 上膠寬度約 1mm

- Anaerobic Retainer (R48) is green penetrating threadlocker and is used to fix the metal tube before assembly at temperatures up to +180°C.
- Thread Lock (T43) is blue low strength threadlocker and is applied to the small screw (threads) or metal parts before assembly to prevent loosening. Ensure to apply only a small amount and wipe surplus off. When disassembling, recommend to heat the metal joint about 15 Seconds.
- Grease is kind of lubricant additive which is applied to the one-way bearings or thrust bearing.

Based on parts physical attributes, please apply small amount of the relative glue or grease accordingly to prevent any parts damage or loosening or unexpected danger happened.

- 快乾膠 (R48) 為綠色高強度快速固化的快乾膠，適合於金屬管狀固定用，可耐高溫至 180°C。
- 螺絲膠 (T43) 為藍色低強度螺絲膠，適合小型螺絲；使用於金屬內外徑或膠合螺絲時，請務必適量使用，必要時請用手去除多餘膠量，或拆卸時可於金屬合部加熱約 15 秒。
- 潤滑油 (Grease) 為黃軟潤滑油，適用於車向軸承或止推軸承。

以上各功能膠(油)請依零件屬性需求自行準確並斟酌其用量，以達到最佳組裝狀態，避免因使用不當造成零件損壞或不可預期的意外發生。

T15 is entirely assembled at the factory. Please refer to the instructions in this manual before flying and follow local rules. The helicopter and equipment require routine maintenance. Be sure to retain the manual for future reference.

T15 出廠前已組裝調整完成，飛行前請詳閱操作說明，並遵守當地法規。飛行機及相關設備均需定期維護保養，請妥善保管說明書，以做為日後參考。



WARNING
警告

Prior to every flight, carefully check rotorhead spindle screws, linkage balls and screws, ensure they are firmly secured.

每趟飛行前請仔細檢查，主旋翼夾座橫軸螺絲，以及機身各部位球頭、螺絲、複實上膠膠塞才能升空飛行。

Apply a small amount of T22 thread lock when fixing a metal part.
螺絲鎖劑對於金屬件請使用適量T22(螺絲膠)。

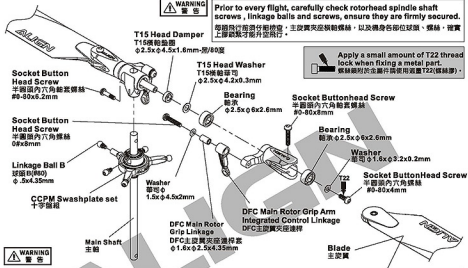

WARNING
警告

1. Do not over-tighten main blade bolts. The blades must be able to swing freely. Over-tightening will prevent the blades from straightening out, resulting in vibrations.
 2. Make sure to ONLY use the T15 Main Blades series on T15 for installation or replacement. The new T15 main blade is special design for T15, it can withstand higher rotor speed, and efficiently resist higher centrifugal tension, to avoid the problem of blade shooting while high rotational speed.
 3. If using T22 or R48: While attaching the T15 main blade. DO NOT ALLOW T22 to come in contact with the main blades. If using T22 and R48 only apply a small amount.
1. 主旋翼固定螺絲不可鎖過緊，要保留旋翼能順暢收折。過緊將會造成旋翼無法伸直而造成飛機抖動。
2. 安裝或更換主旋翼時，請務必搭配新款T15主旋翼。新款的T15主旋翼能抵禦更高的離心力，能承受較高的主旋翼轉速，避免高轉速時葉片脫落發生。
3. T15主旋翼在安裝時，請注意只使用小量螺絲膠(T22)與於主旋翼螺絲上，達到固定效果即可。

EACH LINKAGE ROD ILLUSTRATION 各連桿示意圖

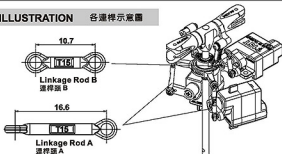



Apply a small amount of T22 thread lock when fixing a metal part.
螺絲鎖附於金屬件時使用適量T22(螺絲膠)。



CAUTION
注意
Already assembled by Factory. Before flying, please check if the screws are fixed with plus.
原裝組裝完成品，每一次飛行前請先確認螺絲是否已上膠不會鬆動。



WARNING
警告
Prior to every flight, carefully check linkage balls and screws, ensure they are firmly secured.
每趟飛行前請仔細檢查，機身各部位球頭、螺絲，確實上膠觀察才能升空飛行。

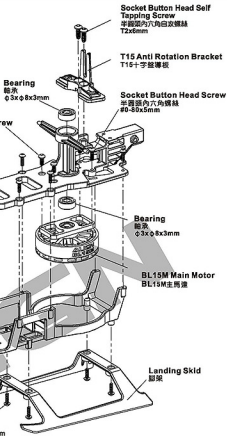

CAUTION
注意
When assembling, first thread the motor wire into the groove of the Vertical Stabilizer Bearing Block, and then align the Tail Motor Mount with Vertical Stabilizer Bearing Block and load.

組裝時，先將馬達線穿入垂直安定器固定座溝槽內，再將尾馬達座與垂直安定器固定座對齊裝入。

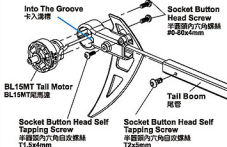

Washer
彈弓 $\phi 1.5x\phi 3.2x0.2mm$

Socket Button Head Screw
半圓頭內六角螺絲 #0-80x4mm

T15 Tail Blade
T15尾旋翼



CAUTION
注意
For T15 Tail Blade assembly, make sure to keep "ALIGN/T15" mark facing outward. Wrong direction installation will cause abnormal tail lock performance.

安裝T15尾旋翼時，請將印有ALIGN/T15字樣的面朝向外；尾旋翼安裝方向錯誤，會造成尾旋翼鎖定異常。

Stagger the plugs to pass through tail boom mount.
馬達插頭以互相錯開的方式穿過尾管固定座。



Insert tail motor into motor wire socket through the large hole opening.
將尾馬達接頭裝入馬達線接頭，從大孔處裝入。



Ensure motor plugs are plugged in all the way.
請確認馬達線接頭確實插到底。

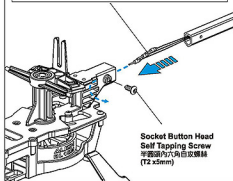
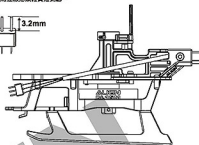

Socket Button Head
Self Tapping Screw
半圓頭內六角自攻螺絲
(T2 x5mm)



WARNING
警告

Prior to every flight, carefully check linkage balls and screws, ensure they are firmly secured.
每遍飛行前請仔細檢查，機身各部位球頭、螺絲，確實上緊鎖緊才能升空飛行。

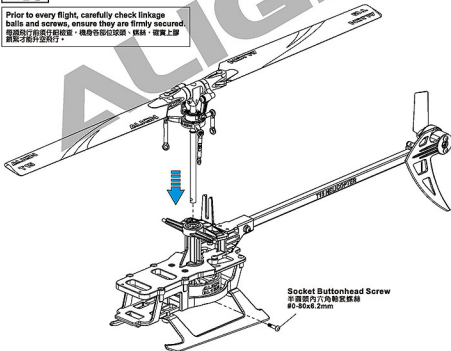

Socket Buttonhead Screw
半圓頭內六角軸攻螺絲
#0-80x6.2mm

SERVO SETTING AND ADJUSTMENT 伺服器設定與調整

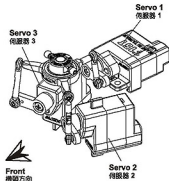

- Servos must be installed in this orientation: with the nose point forward, right forward (Servo 3) is aileron, left forward (Servo 2) is pitch, mid-rear (Servo 1) is elevator.
 - Swashplate type setting on the transmitter should be set to H-1 traditional swashplate type. If swashplate movement is incorrect after assembly per instruction, please double check for correct connection. JR/Spektrum transmitter should be set to 1-Servo-Normal swashplate type.
1. T15伺服器的安裝方式只有一種。當機頭朝前時，右側為副翼；左側為俯翼；右後為升降。副翼、俯翼不可裝錯。如果沒依照圖示連結，直昇機動作會不正確。
2. 遙控器十字盤設定，必須選擇H-1傳統十字盤模式。依照圖示安裝完畢，如果十字盤動作不正確，請檢查伺服器接線是否正確。JR/Spektrum遙控器為1-Servo-Normal十字盤模式。

Channel layouts of each radio brands 各廠遙控器頻道配置

	CH1	CH2	CH3	CH4	CH5	CH6
ALIGN A10	AIL 副翼	ELE 升降舵	THR 油门	RUD 舵舵	GYRO 陀螺	PIT 俯翼
JR/SPEKTRUM	AIL 副翼	ELE 升降舵	RUD 舵舵	GYRO 陀螺	PIT 俯翼	

T15T Digital Servo / T15T 數位伺服器

(Servo 1 / 伺服器 1):

1. 1520 μ s standard band / 1520 μ s 寬頻系統
2. Stall torque / 輸出扭力: 0.4kg.cm (5V)
3. Motion speed / 動作速度: 0.065sec/60° (5V)
4. Dimension / 尺寸: 17.1x 24.9 x 11.6mm
5. Weight / 重量: 4.6g

Cross Screw
螺絲十字螺絲
M1.7x4mm

Socket Button Head Self
Tapping Screw
半圓型六角自攻螺絲
T2x5mm

Linkage Ball A(T1.5)
球頭A(T1.5)
φ 2.5x4.95mm

Linkage Ball A(T1.5)
球頭A(T1.5)
φ 2.5x4.95mm

Cross Screw
螺絲十字螺絲
M1.7x4mm

T15 Digital Servo / T15 數位伺服器

(Servo 2-3 / 伺服器 2-3):

1. 1520 μ s standard band / 1520 μ s 寬頻系統
2. Stall torque / 輸出扭力: 0.4kg.cm (5V)
3. Motion speed / 動作速度: 0.065sec/60° (5V)
4. Dimension / 尺寸: 23.2 x 24.9 x 9.1mm
5. Weight / 重量: 4.8g



Check if the screws are firmly
tightened before flight.
飛行前再次確認螺絲是否鎖緊。

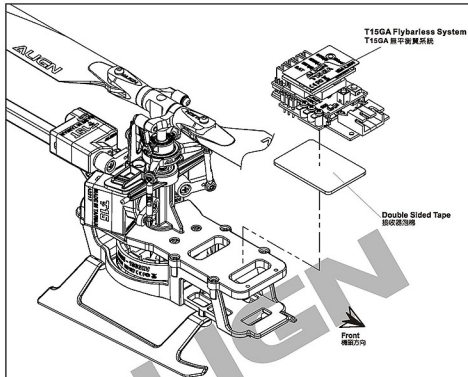

1. T15GA can only be installed face down, with antenna point towards from the helicopter.
2. Incorrect installation will cause incorrect compensation of the helicopter swashplate. Flying with incorrect installation will result in crash.
3. T15GA Flybarless system must be mounted using the Align supplied double sided tape; the use of other tapes will affect flight performance.

1. T15GA 的安裝方式只有一種，必須如圖示的安裝方式。
2. 安裝錯誤會造成直升機十字盤修正錯誤，進行飛行會有墜機的危險。
3. T15GA 無平衡翼系統，必須使用亞拓提供的專用接收器泡棉來固定，如果使用其他泡棉會影響飛行性能。

MOTOR WIRE CONNECTED ILLUSTRATION 馬達接線圖

Be careful when plugging and unplugging, to avoid damaging the power cord. The damage will cause the motor to fail to operate normally.

接線時務必謹慎插拔，避免因折壞損傷電線，造成馬達無法正常運作。

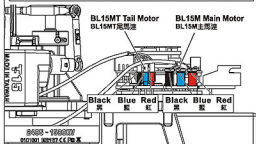

BATTERY INSTALLATION 電池安裝方式

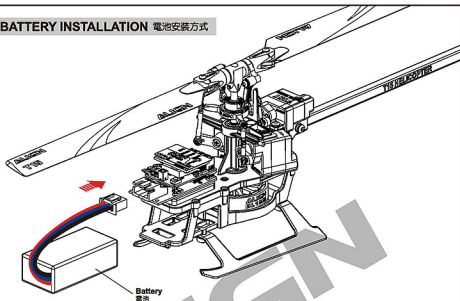

CANOPY ASSEMBLY

機頭罩安裝

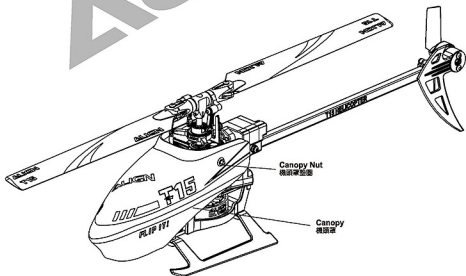

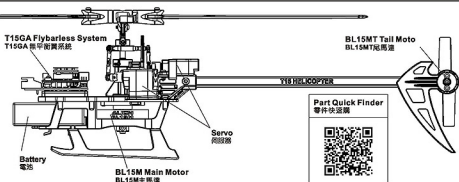

T15G WIRING DIAGRAM

T15G 接收器接線示意圖

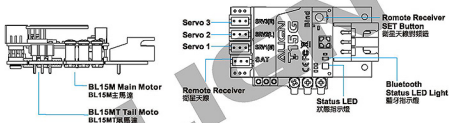

T15GA WIRING DIAGRAM

T15GA 接收器接線示意圖

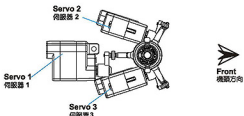
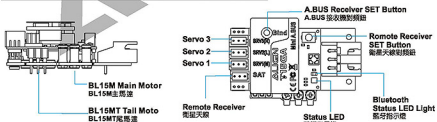

GENERAL FLIGHT 一般飛行模式



Stick position at high/Throttle 65%/Pitch +10°
搖桿高速/油門65%/Pitch +10°

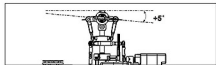

Stick position at Hovering/Throttle 65%/Pitch 5°
搖桿停懸/油門65%/Pitch 5°



Stick position at low/Throttle 0%/Pitch -2°
搖桿低速/油門0%/Pitch -2°

3D FLIGHT 3D特技飛行模式



Stick position at high/Throttle 80%/Pitch +12°
搖桿高速/油門80%/Pitch +12°



Stick position at middle/Throttle 80%/Pitch 0°
搖桿中速/油門80%/Pitch 0°



Stick position at low/Throttle 90%/Pitch -12°
搖桿低速/油門90%/Pitch -12°



1. Pitch range: Approx 26 (± 13) degrees.
2. If the pitch is set too high, it will result in shorter flight duration and poor motor performance.
3. Setting the throttle to provide a higher speed is preferable to increase the pitch too high.

1. 螺距(Pitch)總行程約26°(±13)。
2. 過大螺距設定，會導致動力與飛行時間降低。
3. 動力提升以較高轉速的設定方式，優於螺距過大的設定。

GENERAL FLIGHT 一般飛行模式

	Throttle 油門	Pitch 螺距
H	65% High speed 65% 高速	+10°
3	65%	
2	65% Hovering 65% 停懸	5°
1	65%	
L	0% Low speed 0% 低速	-2°

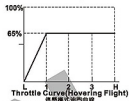

Pitch and Rotation Speed Pitch 螺距與轉速

TIP: It is recommended to use a lower pitch setting when using higher RPM/head speed. This will allow for better power.
提示：當您使用較高轉速/高轉速/高動力頭速度時，請降低螺距 Pitch，將獲得更佳動力效能。

IDLE 1: SPORT FLIGHT

	Throttle 油門	Pitch 螺距
H	80%	+12°
3	80%	
2	80%	0°
1	80%	
L	80%	-12°

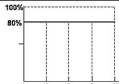

Throttle Curve (Simple Aerobatic Flight)
空中飛行模式油門曲線

IDLE 2: 3D FLIGHT

	Throttle 油門	Pitch 螺距
H	90% High 100% 高	+12°
2	90% Middle 90% 中	0°
L	90% Low 100% 低	-12°

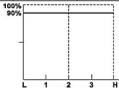

Throttle Curve (3D Flight)
特技飛行模式油門曲線

T15GA Flybarless system integrates; a 6-axis gyro, ARM Cortex M432 bits processor, ALIGN A.BUS, Bluetooth, and dual ESC. Although it's small, the redesigned system is powerful, allowing the T15 to perform maneuvers just like a big scale heli copter. Moreover, Attitude Auto-Level Mode is specifically designed for beginners to provide an easy and fun flying experience. The built-in Bluetooth module allows for easy setup or adjustment of the flight parameters and firmware upgrades at any time using the FREE APP.

T15GA無平衡翼系統整合了高精度6軸陀螺儀、頂級ARM Cortex M4 32位元處理器、ALIGN A.BUS接收器、藍牙與雙電子變速器，體積小、功能強大，搭載在T15展現出非凡性能，有如大型直昇機般的飛行特性。且針對初學入門者設計的姿態自動飛行模式，更能讓飛行直昇機變成容易簡單的樂趣。此外，內建藍牙功能，可透過手機APP隨時隨地調整設定參數與功能升級。

FEATURES 產品特色



6-axis Gyro : 3-axis gyroscope + 3-axis accelerometer using a superior ARM Cortex-M4 32-bits processor. 3D feeling is superior while auto-level ability is also agile and stable.

六軸陀螺儀：由三軸陀螺儀和三軸加速並配合頂級的ARM Cortex M4 32位元處理器，提供流暢的3D飛行以及敏捷的自動穩定。



Attitude Mode Self Leveling / Rescue Mode : While there is no stick input for helicopter, the heli will auto-level and still keep at horizontal position. While wrong stick input is given or heli is in trouble, or you are in panic, activate the rescue mode by flipping a switch on the radio to keep helis at a level position.

姿態自動修正/一鍵救機功能：自平穩定飛行，當搖桿無動作時，直昇機會自動保持水平姿態。在動作錯誤或恐慌中，透過動作桿釋放動來恢復機身水平姿態。



For Beginners : suitable for beginners.

初學者適用：非常適合初學者剛入門飛行。



3D Mode : Brand new DFCS (Direct Flight Control System) Controller allows to control real time flight. Strong Cortex-M4 Processor allows T15 to fly just like big scale helicopters.

3D模式：最新研發的DFCS(Direct Flight Control System)飛控系統讓使用者感受到真實的與直昇機連結。這個飛行控制系統用威力強大的Cortex-M4處理器讓微型直昇機的反應像大尺寸的一般。



Bluetooth Connection : Utilizes with Bluetooth for phone setup adjust.

支援藍牙功能，可透過手機設定調整。



App Interface Parameter Adjustment : Support for mobile devices, iPad, iOS & Android allows easy set up and adjustment to flight parameter settings. The APP makes firmware updates easier to install. Download the FREE APP to get the latest firmware update with additional improved functions.

APP設定介面調整：支援IOS、Android系統手機/平板，透過APP可以隨時隨地進行設定與飛行參數調整。主控升級更加簡單，只需透過手機APP功能即可進行軟體更新，取得最佳優化與新增功能。



Ready-to-Fly(RTF)

到手即飛。

SETUP PRE-CHECK 設定前注意事項

1. Before flying, the T15GA must initialize properly and the transmitter must have enough battery power.
2. There is only one way to connect the servos to the T15GA. Failure to connect the servos properly will result in damage to the T15GA or servo.
3. The T15GA status LED must be before flying. (Please refer to page 27)
4. While using T15GA Flybarless system, use H-1 or Normal (Spektrum) for traditional swashplate type (1-Servo-Normal).
5. While using T15GA Flybarless system, the transmitter subtrim, and servo Endpoints (Travel. ADJ) must be set to default setting. Do not adjust subtrim or end point in your transmitter. Do not activate the Swash Mix function.
6. While using T15GA Flybarless system, the rudder gain is adjusted in the FREE APP. The GYRO channel (CH5) is designed to switch between 3D mode and Attitude Auto-Level mode.

1. 在每次飛行之前，請確認T15GA是否固定良好，並檢查遙控器是否有足夠電量。
2. T15GA安裝的方式與伺服器接線方式只有一種，請勿任意更改安裝方式，以免修正錯誤造成危險。
3. 飛行前，請注意T15GA燈號指示要正確，才可進行飛行。(參考第27頁 指示燈說明)
4. 使用T15GA無平衡翼系統，遙控器的十字盤類型必須為H-1傳統十字盤模式。JR/Spektrum遙控器為1-Servo-Normal十字盤模式。
5. 使用T15GA無平衡翼系統，遙控器內的微調、Endpoint (Travel. ADJ) 伺服器行程設定，必須為預設值不可變動設定。Swash Mix十字盤混控功能請勿開啟。
6. T15GA無平衡翼系統，舵舵感度調整完全由APP上來調整設定，GYRO頻道(CH5)為配置切換3D模式與姿態自動飛行模式開關。



For safety reasons, please remove all motor cables from T15 during T15GA setup.
設定T15GA的過程中，必須將馬達線拆掉，避免發生不可預期的危險。

SOFTWARE DOWNLOAD AND INSTALLATION T15G下載安裝

T15GA Flybarless System support Android system version 4.4 above and iOS 8.0 above.
T15GA無平衡翼系統支援Android手機系統版本4.4以上、以及iOS系統8.0以上，皆可使用。

Prior to leaving the factory, T15GA Flybarless system is flashed with the latest firmware version.
Visit Align at www.align.com.tw for the latest news and firmware updates.

T15GA無平衡翼系統，在出廠前已是最新版本，請安心使用。
您也可以連結至亞拓T15G網站查詢，隨時更新亞拓發佈的最新版本及各項最新訊息。

1. T15 is assembled in the factory which includes configuration of the T15GA Flybarless system.
T15 is a RTF model, only requiring the use of either an ALIGN A10 transmitter or Spektrum DSM2/DSMX / JR DMSS/DSM2 satellite and transmitter. Follow the binding process as listed below. In the Transmitter select a helicopter model.
Use H-1 or Normal (Spektrum) for traditional swashplate type (1-Servo-Normal). Selecting the wrong swashplate type will result in flight error.

T15整機全都是由原廠組裝調整完成，包括T15GA無平衡翼系統所有的參數設定，您只要搭配ALIGN A10遙控器或Spektrum DSM2/DSMX、JR DMSS/DSM2衛星天線與遙控器，並對頻完成以下設定就可以飛行了。

遙控器必須選擇直昇機模式，十字盤類型請選擇H-1傳統十字盤（1-Servo-Normal）。

如果十字盤類型設定錯誤，會造成動作不正確且無法飛行。



Never enable your transmitter's mixing function.
請勿開啟遙控器混控功能。

2. Please scan QR Code for link to ALIGN website to find related software, or search "ALIGN T15G" in IOS / Android app store.

請掃描QR Code連結亞拓網站下載相關軟體，或是在IOS/Android App store搜尋"ALIGN T15G"。

<https://www.align.com.tw/index.php/download-en/t15g>

Compatible with



3. Turn on the transmitter and connect the battery to the T15.

開啟遙控器與接上電源



Power ON
電源開

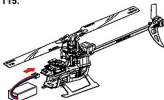

PROGRAM SPLASH PAGE 程式版本宣告

The splash page is displayed when the program is launched. The T15G program page appears two seconds later.

第一次進入程式，或重新登入顯示版本宣告頁面兩秒後自動進入T15G首頁。

The T15G Disclaimer is displayed when the APP is launched for the first time. Please, read Align T15G System Agreement in it's entirety.

T15G 免費聲明：

首次使用T15G，系統會顯示免費聲明，請詳讀內容！一旦下載、安裝或使用ALIGN T15G軟體或其中任何部分，即表示貴用戶同意遵守各項條款與細則。



CONNECTION STATUS LED DESCRIPTION 連線狀態燈號說明

Green light indicates a normal connection. Red light T15G APP is not connected. The screen will display T15G current firmware and interface version

綠燈為正常連線；紅燈為未連線。

當T15G為正常連線狀態下，系統會顯示目前T15G的操作介面版本與程式版本。



注意

Do not disconnect the battery until the parameter store process is finished. After completing the T15G setup, return to the APP homepage and click "Setup Confirm/Disconnect". Wait till T15G stores all parameter settings, then the setup is completed.

當T15G設定完畢，不可直接斷電或拔掉直昇機電池，必須回APP首頁點按「設定確認/中斷連線」，確認儲存設定值後才算完成設定步驟。

Click on "T15G Setting" to enter the setup page.

選擇「T15G設定」進入T15G目錄選單。

READ AND SAVE THE FILE 讀取及儲存檔案

T15G provides a read and save function for parameter settings. Make sure to save all your settings after setup and before performing a system update.

T15G提供讀取及儲存參數設定的功能，在各項選單設定完畢或準備更新程式之前，可以將喜好的參數設定儲存至手機，做為日後調整設定使用。

Load Parameter File
讀取參數設定檔案

Save the File
儲存參數設定檔案

T15G SETTING SELECTION T15G目錄選單

The T15G Setup Menu allows quick access to each menu selection. When configuring T15G for the first time we recommend using the arrow button to follow setup sequence.

由T15G目錄選單可快速進入所要的選項頁，首次設定T15G建議依序進行設定調整與檢查。



注意

Do not disconnect the battery until the parameter store process is finished. After completing the T15G setup, return to the APP homepage and click "Setup Confirm/Disconnect". Wait till T15G stores all parameter settings, then the setup is completed.

當T15G設定完畢，不可直接斷電或拔掉直昇機電池，必須回APP首頁點按「設定確認/中斷連線」，確認儲存設定值後才算完成設定步驟。



TRANSMITTER TYPE 遙控器選擇

Select the transmitter type; T15G Flybarless system built-in ALIGN A.BUS receiver, Spektrum/JR SAT DSM2, Spektrum SAT DSMX (SPM9645), JR DMSS SAT receiver. Please choose the transmitter for T15. RTF for using ALIGN A10 transmitter; the addition of a remote satellite is required for Spektrum/JR system.

請選擇所使用遙控器類型。T15G無平衡翼系統內建ALIGN A.BUS接收機，支援外接Spektrum/JR SAT DSM2、Spektrum SAT DSMX (SPM9645)、JR DMSS SAT接收器使用。請選擇所使用的遙控器系統，使用ALIGN A10遙控器可以直接對頻使用。Spektrum/JR請外接衛星天線對頻使用。



1. Binding varies based on selected receiver type. Please, refer to the receiver manufacture manual for instructions on binding and wiring.
2. When first time setup, make sure to perform and complete travel range calibration, or it may lead to abnormal system control.

1. 各廠牌接收器的對頻方式不同，請依照原廠指示對頻完成後再進行接線。
2. T15G初次設定時，請務必正確執行遙控器行程校正，否則會造成遙控器控制異常。

T15G is compatible with the Spektrum receiver SPM9645. Please, refer to Allign's website for announcements about the T15G flight controller system, firmware updates, receivers compatibility, and support.

T15G可相容spektrum接收器型號為SPM9645。各類型接收器相關支援及更新，請隨時關注亞拓發佈T15G飛控系統的最新版本及各項最新訊息。



①

②

Click "OK" to save after select the receiver type.
選擇接收器類型後按 (確定)。

TRANSMITTER BINDING 遙控器對頻

ALIGN A.BUS BINDING

ALIGN A.BUS 對頻方式



Press and hold "Confirm" button
長按住 "Confirm" 鍵

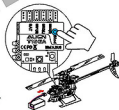

- ① Select T15G built-in ALIGN A.BUS receiver in APP interface, then save the setting and confirm.
- ② Press and hold "CONFIRM" button, then turn on A10 transmitter to enter the bind process.
- ③ Press the "Bind" button then T15 connect to the battery.

請先選擇T15G APP內建ALIGN A.BUS接收機，並確認儲存設定。

遙控器長按住 "CONFIRM" 鍵後，開啟遙控器電源進入對頻模式。

按住對頻鍵後接上T15電源。

LED light will flash slowly.
LED燈慢速閃爍



Solid LED light indicates the Satellite is bound to the Transmitter.
LED燈恆亮



- ④ LED light will flash slowly to start binding.
接收機LED燈慢速閃爍進入對頻。
- ⑤ Remove T15 battery, turn off A10 transmitter. Wait and again turn on A10 transmitter, then connect the battery to T15.
拔掉T15電池、關閉A10遙控器電源，先關閉A10遙控器電源再重新裝回T15電池。
- ⑥ Once binding is complete satellite receiver LED will be solid.
對頻完成，狀態指示燈會恆亮，確認對頻完成。

DSM2/DSMX SATELLITE BINDING DSM2/DSMX衛星天線對頻方式

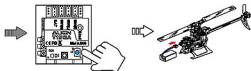

- ① Select T15G / DSM2/DSMX receiver in APP interface, then save the setting and confirm.
請先選擇T15G APP內DSM2/DSMX接收機，並確認儲存設定。

- ② Press and hold the "Bind" button and connect to the battery to start binding
長按對頻組進行對頻，同時接上電源。

Flashing LED Light
LED燈快速閃爍



- ④ The LED light on Satellite will blink. You are now in binding mode
進入對頻模式。



- ⑤ Press the "Bind" button on the transmitter to power on.
遙控器按對頻組開機。

Solid LED light indicates the Satellite is bound to the Transmitter.
LED燈恆亮



- ⑥ Once binding is complete satellite receiver LED will be solid.
對頻完成，狀態指示燈會恆亮，確認對頻完成。

DMSS SATELLITE BINDING DMSS衛星天線對頻方式



Flashing LED Light
LED燈快速閃爍



- ① Select T15G / JR X.BUS (Mode A only) receiver in APP interface, then save the setting and confirm.
請先選擇T15G APP / JR X.BUS (Mode A only)接收機，並確認儲存設定。

- ② Please re-connect to the power
重新接上電源

- ③ The LED light on Satellite will blink. You are now in binding mode
進入對頻模式。



- ④ Transmitter Binding (JR X.Bus Mode A only)
遙控器對頻 (JR X.BUS MODE A ONLY)



Solid LED light indicates the Satellite is bound to the Transmitter.
LED燈恆亮

- ⑤ Once binding is complete satellite receiver LED will be solid.
對頻完成，狀態指示燈會恆亮，確認對頻完成。

TRANSMITTER SETTING 遙控器設定

RC Transmitter Stick Direction and Travel Range Calibration:

1. Before starting, set all EPA / Travel ADJ max and min value on your TX to default 100%, and neutralize all subtrims to "0".
2. Move your RC transmitter sticks and confirm travel direction on aileron/ elevator/ throttle/ rudder correctly matches the PC interface display. Select the "Reverse" on corresponding channels that need reversing.
3. This function is only active while connected to program.

遙控器搖桿方向、行程校正：

1. 設定此項目前，遙控器內所有頻道Endpoint (Travel ADJ) 伺服器行程最大最小值要為預設值 100%，所有副調也必須為預設值 "0"。
2. 確認遙控器各頻道動作，如副翼、升降、油門、尾舵、GYRO、橫距方向是否正確，如果介面顯示方向與搖桿方向相反，可點選該頻道上的"正反向"來改變動作方向，讓介面與遙控器動作一致。
3. 此功能僅支援在連線狀態下使用。

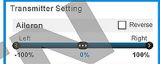
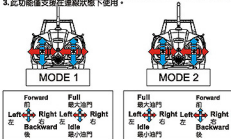

4. Select "Stick travel calibration" and move all sticks on RC transmitter to maximum and minimum position, then click on "Complete" to finish.

4. 點選"遙控器行程校正"將遙控器搖桿都推至最大、最小，然後按下"完成"來結束校正。

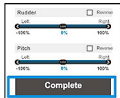

- 1 Click on "Start". 點選開始進行遙控器行程校正

- 2 Move all sticks on RC transmitter to maximum and minimum position. 將遙控器搖桿推至最大及最小

- 3 Click on "Complete" 完成



Make sure to set the transmitter throttle curve and collective curve to be default settings 0, 50, 100 as slash line.

校正時遙控器油門曲線螺旋距曲線必須為預設值0、50、100斜直線。



After completing transmitter range setting, all channels max. and min. gain value must be 100% & -100%. If the gain value is set too large or too small, it will cause abnormal flight performance and unexpected danger.

遙控器行程校正後，各頻道最大最小值必須為100%、-100%。如果最大、最小不正確會造成飛行動作異常與不可預期的危險。

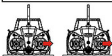
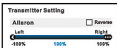

Max. gain value must be 100% 最大值必須為100%

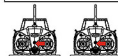
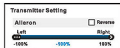

Min. gain value must be -100% 最小值必須為-100%

FLIGHT MODE SETUP 飛行模式開關設定

T15G Attitude Auto-Level mode is activated using the gyro/gear channel (CH5). Assign the gyro/gear channel (CH5) to a 2-position switch on your RC transmitter, allowing the switch to activate Attitude Auto-Level mode. Use the APP to confirm the switch is appropriately assigned and active. Important: Adjust rudder gain only in the APP and not the transmitter.

T15G無平面翼系統具備姿態自穩模式，模式切換為利用GYRO頻道(CH5)指定一個開關來做自穩模式的開關，而利用遙控器內GYRO道單或CH5頻道做為自穩模式的起點，原尾舵感應值則完全由APP內做設定，飛行模式開關切換不會改變尾舵感應設定值。將遙控器GYRO頻道(CH5)選擇一個兩段開關來對應切換模式，各型號遙控器開關配置設定不相同，可依使用習慣選擇開關。

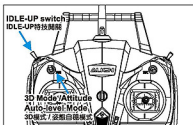

3D Mode
3D模式



Attitude Auto-level Mode
姿態自穩模式

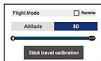

CAUTION
注意

Flight mode switch must be set isolated. Do not set Attitude Auto-Level gyro/gear (CH5) to the same switch as IDLE-UP (Flight mode) switch.

飛行模式開關為獨立開關，不可與IDLE-UP特技開關設定在相同開關。

SWASHPLATE 十字盤中立點調整

Servo Neutral point and Level point Adjustment : Adjust each servo individually to the neutral position (90 degrees) using the APP interface to ensure all servo arms are in the horizontal position.

此設定為調整各伺服器中立點與十字盤的水平。利用介面上的伺服器中立點調整，逐一調整各伺服器中立點，讓伺服器擺臂為水平，且十字盤也要為水平。

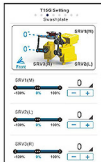
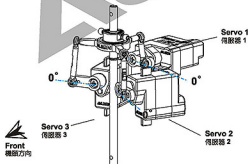

While using the line bar to set up servo neutral setting, there will be servo image flashing showing the one you're adjusting on the interface.

調整伺服器中立點拉動左右移動時，介面顯示會依您正在調整的伺服器出現閃爍，提醒您正在設定的是哪一個伺服器中立點。



COLLECTIVE 集體螺距

After completing servo leveling adjustment, click to "0 degree collective pitch" to adjust collective pitch.

You are able to check collective pitch by folding both main rotors to one side (90 degrees); if the main blades are parallel, then pitch is at 0 degree, if they are not parallel to each other, you can adjust the collective pitch using the APP interface.

調整好十字盤水平後，先點選"0度螺距"，調整0度螺距的位置。調整時可將直昇機的主旋翼對折，且將直昇機側到90度擺，如果兩主旋翼為相互平行，則為0度螺距。如果兩主旋翼沒平行呈現角度，利用介面上的螺距微調，將主旋翼螺距調整為0度。

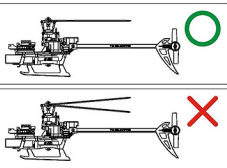

Positive / Negative Collective: After setting 0 degree of collective pitch, then set the Max./Min. collective pitch.

最大最小集體螺距：當0度螺距調整完畢後，且0度螺距必須準確，才可進行最大最小集體螺距調整。

Collective Pitch setting reference:

100% approximated to 12 degree,

85% approximated to 10 degree.

集體螺距設置參考：

設置100%為12度，設置85%約為10度。

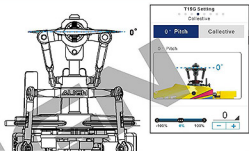

Positive Collective: Move (Push) the throttle stick to the high position for Max. collective pitch adjust via APP interface. Recommend Max. collective pitch for beginners 10 degree and 12 degree for advanced pilots.

最大集體螺距：將油门搖桿推至最高，調整最大集體螺距角度，利用介面來增減最大集體螺距。初學入門玩家建議設定為10度，高階玩家建議設定12度。

Push throttle to highest.
油门推至最高

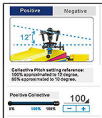
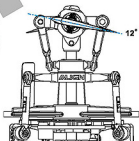

Default Setting: 80%
出廠預設值80%

Negative Collective: Move (Pull) the throttle stick to the lowest position for Min. collective pitch adjust via APP interface. Recommend Max. collective pitch for beginners 10 degree and 12 degree for advanced pilots.

最小集體螺距：將油门搖桿拉至最低，調整最小集體螺距角度，利用介面來增減最小集體螺距。初學入門玩家建議設定為-10度，高階玩家建議設定-12度。

Pull throttle to lowest.
油门拉至最低

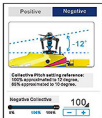
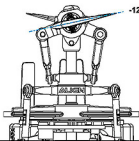

Default Setting: 80%
出廠預設值80%

PARAMETER SETTING 參數設定

It is not necessary to adjust the gain setting, as the T15G Flybarless system default setting is factory set to provide the optimum performance. However this parameter can be adjusted based on your flying style or preference.

Beginner : Suitable for beginners for stable flight.

Advanced : Suitable for average pilots, increases flight agility with advanced and tested parameters settings in the APP

Professional : Suitable for professional pilots

T15G無平衡翼系統出廠預設感度已為最佳適用感度，不需調整即可飛行，你也可以依照個人操控手感與喜好，調整符合需求的飛行特性。

初階：適合剛入門的初學者使用，適合平穩飛行。
中階：適合一般玩家使用，調整後的數據較初階設定略靈敏。
高階：適合專業玩家級使用。

Click "Reset" to revert to system default values. Factory default values are based on Beginner Parameter.

點選“恢復原廠預設值”，將回到原廠預設值。原廠預設為初階的飛行參數值。

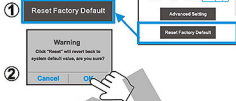

PARAMETER SETUP FUNCTION INSTRUCTION 參數設定功能介紹

CYCLIC ROLL RATE 翻滾速率

Elevator and Aileron Cyclic Roll Rate Adjustment. A higher value provides faster roll rate. Suggest to use default setting for beginner.

調整升降、副翼的翻滾速率。數值越大翻滾速率越快，初學者建議使用預設值。



Default Setting : 30%
出廠預設值為30%。

CYCLIC GAIN 十字盤感度

Swashplate Gyro Gain Adjustment. There may be left/right or front/back vibration on the aircraft if the gain is set too high, suggest to lower down the gain value accordingly.

Default Setting : 50% (The best gain setting)

調整十字盤陀螺儀的感度。當飛行時，若機體有左右或前後快速抖動的現象，表示感度過高，可適當的調低感度。



CYCLIC ACCURACY 十字盤精準度

Cyclic Reaction Accuracy Adjustment. A higher value provides more precise movement. But there may be tracking or vibration if the gain is set too high.

調整十字盤動作的精準度。數值越大，十字盤動作越精準，但過大的數值容易造成追蹤、抖動。



Default Setting : 50%
(The best gain setting)
出廠預設值50%已是最佳感度。

CYCLIC RESPONSE 十字盤反應

Swashplate Direct Control Adjustment. A higher value provides more direct command to swashplate. Make movement more accelerated; Too high value leads to bounce back movement. Too low value leads to sticky reaction feeling

調整十字盤動作的反應。數值越大反應越快越確實，數值越小則反應越慢越不確實。



TAIL RATE 尾舵速率

Rudder Piro-rate Adjustment

調整尾舵自旋的速度。



TAIL GAIN 尾舵敏感度

Rudder Gain Adjustment

調整尾舵的敏感度。



TAIL ACCURACY 尾舵精準度

Rudder Tail-lock Accuracy Adjustment. A higher gain value provides a more accurate tail lock. If the gain value is set too high the tail will rapidly bounce side to side. Default Setting : 50% (The best gain setting)

調整尾舵鎖定的精準度。值越大尾舵鎖定會越確實，但過大的值會造成鎖定反彈。出廠預設值 50% 已是最佳敏感度。



TAIL DELAY 尾舵延遲

Rudder Response Delay Adjustment

調整尾舵反應的延遲。

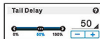

TAIL RESPONSE 尾舵反應

Rudder Direct Reaction Adjustment. A higher gain value provides more tail acceleration reaction ; This is usually not necessary unless the extreme rapid movement required.

調整尾舵動作的反應。數值越大反應越快速確實，數值越小則反應越慢越不確實。



TORQUE COMPENSATION 反扭力補償

Anti Torque Compensation Adjustment.

調整主旋翼產生的反扭力補償。

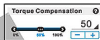

Default Setting : 50%
(The best gain setting)
出廠預設值 50% 已是最佳敏感度。



Do not disconnect the battery until the parameter store process is finished. After completing the T15G setup, return to the APP homepage and click "Setup Confirm/Disconnect". Wait till T15G stores all parameter settings, then the setup is completed.

當T15G設定完畢，不可直接斷電拔除直昇機電池，必須回APP首頁點按設定確認/中斷連線。確認儲存設定值後才算完成設定步驟。

Return to APP Homepage and click "Setup Confirm/Disconnect"

回APP首頁點按（設定確認/中斷連線）。

Confirm/Disconnect

Align T15G is the result of cutting technology, utilizing precision rooms and fine routines. It is stable, feature rich platform of high reliability.

ESC THROTTLE TRAVEL ADJUSTMENT ESC油門行程校正

Although the T15 throttle calibration has been completed in the factory, it's recommended to perform a calibration after binding to ensure smooth motor operation.

Important: Before calibrating ensure the transmitter throttle curve is linear (0,25,50,75,100).

雖然T15油門校正已經在廠內完成校正，但為確保馬達動作的順暢，請務必於遙控器對頻後再進行一次油門校正。
重要提示：校準前確保油門曲線是線性的(0,25,50,75,100)。



- 1 Tap the "Calibration" button for confirmation
點按"校正"確認



- 2 The Bluetooth will disconnect after press "OK", Please reboot to do the throttle calibration.
按下確認後藍牙將會自動斷線，請重開機進行油門校正



- 3 Please re-connect to the power
請重新接上電源

ACCELEROMETER SUBTRIM 加速計微調

Advanced Setting : If the T15 continues to drift in Attitude mode after the Gyro Compensation, you can trim the settings using the accelerometer for correction.

STEP 1 : The T15 does not need to adjust the accelerometer if fly normally, but if there is a drift in attitude auto-level mode, you can fine-tune the accelerometer to correct it.

STEP 2 : Helicopter may drift towards the left slightly in a hover. Adjust compensation to correct angle to prevent left drift. The best angle depends on head speed, pitch, and the blades.

此功能為進階設定，當你已經重新執行陀螺儀校正，但在姿態自穩模式下仍有飛行偏移的情況時，可以透過加速計微調來調整偏移。

步驟 1 : T15 飛行正常時不需調整加速計，但在姿態自穩模式下仍有飛行偏移的情況時，可以透過加速計微調來調整偏移。

步驟 2 : 直升機停懸時稍微向左邊偏移。即可使用此補償功能來調整直升機至正確的角度，以防止朝一邊偏移。最適合的角度則取決於轉速、俯仰角以及主旋翼。



GYRO CALIBRATION 陀螺儀校正

Advanced Setting: The T15 will perform without any changes to advanced settings. If drift becomes an issue, perform a gyro compensation. Place T15 on a level surface in the horizontal position. Pull the elevator stick to the lowest position for approximately 3 seconds, wait until the status LED light rapidly flashes blue, indicating Gyro Compensation has started. When the LED stops flashing blue, the Gyro Compensation process is complete.

此功能為進階設定，T15 飛行為正常情況下，不需進行此功能調整。當你的 T15 飛行時有不正常偏移時，可以進行陀螺儀校正。校正方式：將直升機放置於靜止的水平面上，遙控器升降桿拉至最低約 3 秒，當狀態指示燈呈現藍色快速閃爍，即開始進行陀螺儀校正，藍燈快閃結束即完成校正。

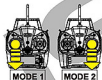

- ① Please re-connect to the power
請重新接上電源

- ② Pull the elevator stick to the lowest position for approximately 3 seconds,
遙控器升降桿拉至最低約 3 秒

- ③ When the blue light stops flashing, the compensation process is complete.
藍燈快閃結束即完成校正。



DO NOT MOVE the T15 during the compensation process, or the compensation will fail to configure properly.

校正過程不可移動直升機，否則會影響校正準確度。

FIRMWARE UPDATE 主程式更新

STEP 1. FIRMWARE DOWNLOAD

T15G will automatically detect your current version. Please, select the latest firmware version and press download.

步驟 1：主程式下載

T15G 會自動判別目前版本，請點選最新版本主程式後，按下載。



Don't do anything when you update. Can not adjust the settings, you can not leave the APP, T15G can not shut down.

各階段更新時請勿做任何動作，不能調整設定、不能鎖出 APP、T15G 不能斷電。

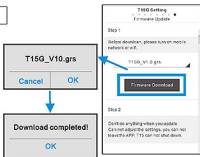

STEP 2. FIRMWARE UPDATE

Press "Firmware Update" after download completes.

步驟2：主程式更新

T15G新版本主程式，下載完成後，按下主程式更新。



Don't do anything when you update. Can not adjust the settings, you can not leave the APP, T15G can not shut down.

各廠牌更新時請勿做任何動作，不能調整設定、不能鎖出APP、T15G不能斷電。



T15GA INDICATOR LED

T15GA 指示燈說明

LED STATUS LIGHT 燈號閃爍顯示說明	LED STATUS LIGHT CONDITION 燈號指示狀況說明
<p>Red / Aqua-blue light flashing 紅色 / 水藍色燈交叉閃爍</p>	<ol style="list-style-type: none"> T15G binding failed. The transmitter is not powered on, the throttle stick is not at the lowest, or the T15G does not recognize 0 throttle. <p>1. T15G 對頻不成功。 2. 遙控器尚未開機或遙控器開機時油門尚未設在最低點。</p>
<p>Blue light turn dark to bright briefly and repeatedly 藍色燈重複快速由暗轉亮</p>	<p>Power On / 3D Mode 開機完成 / 3D 模式。</p>
<p>Aqua-blue light turn dark to bright slowly and repeatedly 水藍色燈重複慢速由暗轉亮 (如同呼吸頻率)</p>	<p>Power On / Attitude Mode 開機完成 / 姿態模式。</p>
<p>Blue light briefly flash then off repeatedly 藍色燈單閃</p>	<p>Connect Successfully APP 連線成功。</p>
<p>Red / Blue light flashing 紅色 / 藍色燈交叉閃爍</p>	<p>System Updating ... 主程式更新中。</p>
<p>Red light flashing 紅色燈單閃</p>	<p>Transmitter lost signal ... 遙控器失去訊號斷訊中。</p>
<p>Green light flashing 綠色燈單閃</p>	<p>Binding ... 對頻中。</p>

SPECIFICATIONS 產品規格

- | | |
|---|---|
| <ol style="list-style-type: none"> 1. Operating voltage range : 2S Li-Po 2. Operating current consumption : <100mA @ 5V 3. Rotational detection rate : 2000°/sec 4. Rudder yaw detection rate : 2000°/sec 5. Sensor resolution : 16BIT 6. Operating temperature : -20°C ~ 65°C 7. Operating humidity : 0% ~ 95% 8. Swashplate Support : MODE H-1 9. Receiver Support : ALIGN A.BUS、DSM2 / DSMX / DMSS 10. Transmit Distance: In open space without interference <150M | <ol style="list-style-type: none"> 1. 操作電壓範圍: 2S Li-Po 2. 工作電流: <100mA @ 5V 3. 剩滾及前滾角速度範圍: 2000度/sec 4. 尾舵角速度範圍: 2000度/sec 5. 感測器解析度: 16位元 (16 BIT) 6. 操作溫度: -20°C ~ 65°C 7. 操作濕度: 0% ~ 95% 8. 支援十字盤類型: H-1 模式 9. 支援發射機類型: ALIGN A.BUS、DSM2 / DSMX / DMSS 10. 接收距離: 空曠無干擾地面 <150M |
|---|---|

FLIGHT MODE INTRODUCTION 飛行模式介紹**ALIGN**

T15GA Attitude Auto-Level mode is activated using the gyro/gear channel (CH5). Assign the gyro/gear channel (CH5) to a 2-position switch on your RC transmitter, allowing the switch to activate Attitude Auto-Level mode. Use the APP to confirm the switch is appropriately assigned and active. Important: Adjust rudder gain only in the APP and not the transmitter.

T15GA無平衡翼系統具備姿態自穩模式，模式切換為利用GYRO頻道(CH5)指定一個開關來做自穩模式的開關，而利用遙控器內GYRO速率或CH5頻道做為自穩模式的啟動，原尾舵感度值則完全由APP內做設定，飛行模式開關切換不會改變尾舵感度設定值。
將遙控器GYRO頻道(CH5)選擇一個兩段開關來對應切換模式，各型號遙控器開關配置設定不相同，可依使用習慣選擇開關。

3D MODE 3D模式

3D Mode : Normal flight and 3D flight mode, without auto level function. Full control by the pilot without any horizontal leveling capabilities.

Control Response adjustment:

Set the exponential (EXP) of Aileron/Elevator/Rudder according to your control feel in 3D mode.

When control response is too fast, decrease EXP -10%~ -60% for Futaba radios ; increase EXP

+10%~+60% for JR radios.

When control response is too sluggish, increase EXP +0%~+30% for Futaba radios; decrease EXP -0%~-30% for JR radios.

3D模式：即一般飛行與3D飛行模式，完全由操控者控制，無自動水平功能。

動作靈敏度調整:3D模式可依個人飛行操作手感調整遙控器副翼、升降、尾舵的EXP；

當3D模式動作靈敏度太大，Futaba調低範圍-10%~ -60%；JR的調高範圍+10%~+60%。

當3D模式動作靈敏度太小，Futaba調高範圍+0%~+30%；JR的調低範圍-0%~-30%。



3D mode is suitable only for experienced pilots without any horizontal leveling capabilities. Beginners should avoid flying in 3D mode or it will cause unforeseen danger and crashes.

3D模式適合有飛行經驗的玩家使用，並嚴禁初學者使用，否則會造成不可預期的結果。在3D模式下無自動水平功能。

ATTITUDE AUTO-LEVEL MODE 姿態自穩模式

Attitude Auto-level Mode: Maintains level. Elevator/Aileron stick inputs are translated as angular command. Larger stick input translates to steeper angles of aircraft tilt

姿態自穩模式：姿態模式會自動保持直昇機水平，升降、副翼搖桿指令為角度命令，搖桿動作越大直昇機動作角度越大。

1. Elevator/aileron stick

升降/副翼搖桿

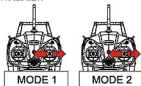

2. Release stick (aircraft automatically levels)

搖桿放開(機體自動回正)

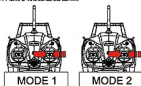

3. In Attitude Mode, the helicopter will auto-level in the air, no GPS positioning function, pilots can set up their flying attitude by themselves. Additional applications of Attitude Mode: While flying in 3D Mode and the helicopter is in a disoriented control position, you can switch from 3D Mode to Attitude mode to keep the helicopter level which we refer to as "Rescue Mode." Rescue Mode is a valuable function for beginners, helping pilots save the helicopter from some crashes. However, please be aware of the height and location of the helicopter before activating Rescue Mode; otherwise, in some cases, you might hit the ground or obstacles when enabling Rescue Mode.

姿態模式可以有其他的運用，當你在3D飛行模式下失去方向與控制錯亂時，可以將飛行模式切換到姿態模式，直昇機會回正保持水平，作為失控救援(一键救援)功能。一键救援為學習的輔助功能，救援的主要控制權是在操控者手上，如果飛行區域有障礙物或飛行高度過低，就有可能在救援過程撞擊障礙物或地面，所以在3D模式切換到姿態模式時，必須控制好高度與直昇機位置，才可確保每次救援成功降低直昇機損傷。

IDLE-UP switch
IDLE-UP特技開關

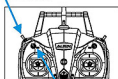

3D Mode / Attitude
Auto-level Mode
3D模式 / 姿態自穩模式

3D Mode
3D模式

Attitude
Auto-level Mode
姿態自穩模式



3D Mode
3D模式



Attitude
Auto-level Mode
姿態自穩模式



- Flight mode switch must be set isolated. Do not set Attitude Auto-Level gyro/gear (CH5) to the same switch as IDLE-UP (Flight mode) switch.
- Make sure not to do extreme 3D or flip maneuver 30 sec. before switching 3D mode to attitude mode as it may cause system error and lead to crash and damage parts.

1. 飛行模式開關為獨立開關，不可與IDLE-UP特技開關設定在相同開關。
2. 使用一键救援功能前30秒內請勿執行劇烈3D與翻滾動作，否則會導致T15姿態識別異常，降低救援效果，甚至造成直昇機失控掉機，導致零件損壞。

FEATURES 特點說明

1. AFHDS2A(Automatic Frequency Hopping Digital System Second Generation) features with superior protection against interference, low power consumption, and high sensitivity receiver.
2. Chinese/English language and supports both helicopters, multi-copters and fixed wing aircrafts.
3. Independent identification ID enhance the system stability of proactive anti-interference.
4. Radio stick features with dual bearing structure providing much precise and agility control.
5. Supports MODE1 ~ MODE4.
6. High efficiency Omni-directional gain antenna maintaining a strong reliable connection.
7. User-friendly monitor interface features with much direct and convenient operation.
8. Feature with update function.

1. 採用AFHDS 2A增強型自動跳頻系統，抗干擾、低功耗、高敏感度接收。
2. 中英文介面，具備3種模型類型：直昇機、多旋機、固定翼。
3. 獨立身份識別ID，提升系統主動抗干擾的穩定性。
4. 搖桿模組採用雙滾珠軸承結構，提供更精準、更細膩的操控手感。
5. 支援MODE1、MODE2、MODE3、MODE4操作模式。
6. 採用高效率全頻增益天線，大幅提升控制距離。
7. 人性化直觀的操作介面，操作使用更直覺、更方便。
8. 具備更新功能。

AFHDS
10 CHANNELS
2.4GHz
TRANSMITTER



Please visit Align download area to get the completed instruction manual at Align website.

詳細的A10遙控器說明介紹，請掃描QR Code連結亞拓網站下載相關資訊。完整的說明書請至官網下載專區下載。
<http://www.align.com.tw/A10>

TRANSMITTER SETUP PARAMETERS DIAGRAM 遙控器設定表

T15 already has all T15GA parameters configured at the factory. Just follow the diagram below and enter all parameters into the transmitter and bind the radio, the helicopter will be ready to fly. The parameters in diagram below is suitable for beginners and general 3D flying, but can be adjusted to suit personal flying preference.

T15 出廠時已經完成T15GA所有設定，只要將下表的遙控器各項參數輸入到遙控器中，以及完成對頻動作就可以進行飛行。下表參數適用初學基礎飛行以及一般3D飛行使用，您也可以依照個人飛行習慣來調整遙控器參數。

ALIGN A.BUS SYSTEM ALIGN A.BUS 系統

	AIL 副翼	ELE 升降	THR 油门	RUD 尾舵	GYRO 感應	PIT 俯仰
Servo Reverse 伺服器正反轉	Normal 正向	Normal 正向	Normal 正向	Normal 正向	Normal 正向	Normal 正向
D / R 雙量比率	▲ 100 % ▼ 100 %	▲ 100 % ▼ 100 %		▲ 100 % ▼ 100 %		
EXP 動作曲線	▲ -30 % ▼ -30 %	▲ -30 % ▼ -30 %		▲ -40 % ▼ -40 %		
End Point Adjust 伺服器行程量	▲ 100 % ▼ 100 %	▲ 100 % ▼ 100 %	▲ 100 % ▼ 100 %	▲ 100 % ▼ 100 %	▲ 100 % ▼ 100 %	▲ 100 % ▼ 100 %

Swash type 十字盤類型	Helicopter Variable Pitch				
	General Mode / 一般模式 70 %			AttitudeControl Mode / 姿態模式 0 %	
Gyro gain 尾舵感應					
Normal Throttle Curves 一般飛行油门曲線	L	1	2	3	H
	0 %	65 %	65 %	65 %	65 %
Normal Pitch Curves 一般飛行螺距曲線	L	1	2	3	H
	45 %	60 %	70 %	78 %	100 %
IDLE-UP Throttle Curves 3D飛行油门曲線	L	1	2	3	H
	90 %	90 %	90 %	90 %	90 %
IDLE-UP Pitch Curves 3D飛行螺距曲線	L	1	2	3	H
	0 %	25 %	50 %	75 %	100 %

This new Brushless motor developed by the ALIGN POWER R&D TEAM is packed with the latest cutting-edge technology available today. It features exceptional levels of high-torque power. The 15M main motor utilizes a 14-pole outrunner stator-rotor and unrivaled Ndfeb extra-strong magnets that traditional magnets cannot compare to. Also included is a high temperature, wear-resisting, low friction, double ZZ high-efficient bearing. The 15M main motor is the most revolutionary motor operating on low current amperage and delivering high torque to RC models.

由亞拓動力團隊獨家研發出新款的無刷馬達，具有超高扭力特色，採用12槽矽鋼片、14個外轉子以及傳統磁鐵無法比擬的鈰鐵磁超強磁鐵，搭配高溫耐用的雙ZZ超高效能精密軸承設計，電流低、扭力強，將是下一波動革命中最具代表性的一顆星。

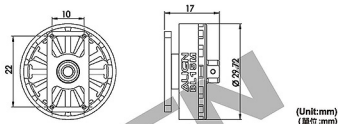
15M MAIN MOTOR (1500KV/2405) 15M主馬達(1500KV/2405)

 (Unit:mm)
(單位:mm)

SPECIFICATION 尺寸規格

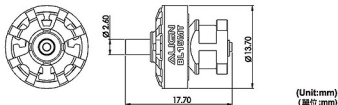
KV	KV值	1500KV(RPM/V)	Input voltage	輸入電壓	2S
Stator Diameter	定子外徑	24mm	Stator Thickness	定子高度	5mm
Stator Arms	矽鋼片槽數	12	Magnet Poles	磁鐵極數	14
Dimension	尺寸	Φ 29.72x17mm	Weight	重量	Approx. 約 26.7g

15MT TAIL MOTOR (8000KV/1103) 15MT尾馬達(8000KV/1103)

 (Unit:mm)
(單位:mm)

SPECIFICATION 尺寸規格

KV	KV值	8000KV(RPM/V)	Input voltage	輸入電壓	2S
Stator Diameter	定子外徑	11 mm	Stator Thickness	定子高度	3mm
Stator Arms	矽鋼片槽數	9	Magnet Poles	磁鐵極數	6
Dimension	尺寸	Shaft軸 Φ 2.6x Φ 13.7x17.7mm	Weight	重量	Approx. 約 4.2g

FEATURES

特性說明

1. Persistent maximum current require optimal heat dissipation condition.
2. Supported motor types: 2 poles to 18 poles brushless outrunners.
3. Maximum rotational speed: 2 poles-240000 RPM, 12 poles-40000 RPM.
4. Input voltage: 2S Li-Po.

1. 持續最大電流需在機體散熱良好情況下。
2. 支援馬達型式：2極至18極之內外轉子無刷跑馬達。
3. 支援最高轉速：2極→240000轉，12極→40000轉。
4. 輸入電壓：2S Li-Po。

ESC SPECS

ESC規格

	Continuous Current 持續	Peak Current 瞬間
Main Motor 主馬達	12A	14A
Tail Motor 尾馬達	6A	7A
BEC Output BEC輸出	5V / 2A	5V / 2.5A

ESC POWER ON AND AUDIBLE ALARM INSTRUCTION

ESC正確開機及響音說明

A. POWER ON THE ESC

ESC正確開機過程

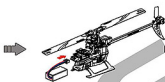

3 short beeps & 2 long beeps
3短音2長音

- ① Turn on the transmitter and push the throttle stick at the bottom position

開啟遙控器電源並將油門推至最低

- ② Connect to the battery and do the transmitter binding

插上電源並完成遙控器對頻

- ③ After plugging in the battery, the motor will emit "3 short beeps and 2 long beeps" then ESC power on successfully.

插上電源後，馬達響音提示出現“3短音2長音”表示ESC開機成功。



After plugging in the batter, the motor only emits "3 short beeps" then the ESC power on was not successful. Reasons:

1. Throttle stick is not at the low or bottom position.
2. The transmitter is not turned on, or the binding process failed.
3. The ESC does not recognize zero (0) throttle. Suggest performing "Throttle Calibration."

插上電源後，馬達響音提示若只出現“3短音”，代表ESC沒有開機成功，可能原因如下：

1. 遙控器油門沒有推至最低。
2. 遙控器沒開機或對頻沒有成功。
3. ESC無法感測油門已推至最低，建議執行油門校正。

B. HELICOPTER LANDING

齒直昇機準備降落時



2 long beeps
2長音

- ① Put the throttle stick at bottom position for landing, then the ESC will emit "2 long beeps".

將油門推至最低準備降落直昇機，電變會發出“2長音”的確認響音。

- ② Make sure to wait till the "2 long beeps" alarm stop, then you can pull up the throttle stick to start next flight or the ESC will not be activated successfully.

當直昇機降落於地面時請務必等待“2長音”響音結束後才可再推油門起飛，如果響音未結束就推油門，電變則不會啟動。



The main feature of ESC, the ESC will emit long beep "2 long beeps" every time while throttle stick is at the bottom position and ESC is been activated successfully.

電變正確開機後，每當油門到最低點位置時，電變也會發出“2長音”響音。

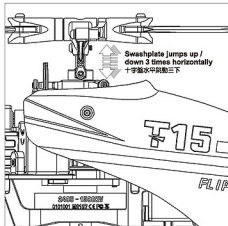

Swashplate jumps up /
down 3 times horizontally
十字盤水平跳動三次

STEP1 步驟1

Turn on the Transmitter, and then turn on T15GA power.
先開啟遙控器電源，再開啟 T15GA 電源。

STEP2 步驟2

The T15GA Blue Light or Aqua Blue Light will be lit solidly.

此時 T15GA 狀態燈會以藍色或水藍色燈殼恆亮。

STEP3 步驟3

As shown in diagram to the left, the swashplate will twitch up and down 3 times after initialization to signal successful startup.

如左圖示，初始化完成後，十字盤會保持水平下小幅跳動三次，表示完成調機程序，如十字盤為傾斜跳動三次，請檢查伺服器是否依照指示安裝。



Swashplate jumps up and
down 3 times horizontally
represents successful
initialization.
十字盤水平跳動三次代表正常調機



Swashplate jumps up and
down 3 times tilted
represents setup error.
十字盤傾斜跳動三次代表伺服器安裝錯誤

STEP4 步驟4

Tilt the helicopter forward and swashplate should tilt back to compensate. If reversed, perform the flybarless initial setup again and adjust the elevator reverse setting.

將直昇機往前傾，陀螺儀應將十字盤向後修正，如果反向，請檢查 T15GA 是否依照指示安裝。

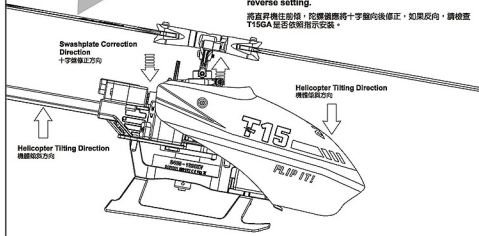

Swashplate Correction
Direction
十字盤修正方向

Helicopter Tilting Direction
機體傾斜方向

Helicopter Tilting Direction
機體傾斜方向

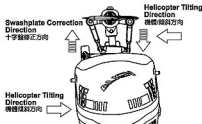

STEP5 步驟 5

Tilt the helicopter right, gyro should tilt the swashplate left to compensate. If reversed, please check for the correct installation direction of T15GA.

將直昇機往右傾，陀螺儀應將十字盤往左修正，如果反向，請檢查 T15GA 是否依照指示安裝。

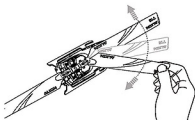

STEP6 步驟 6

The main blade screws must never be over-tightened. Use hand to confirm main blades can slightly move. The tightness of the two-blade must be the same. Uneven tightness or over-tightening will cause body shake and sudden high/low or right/left flight and can cause out-of-control flight. Before flying, always perform a preflight check. Regular maintenance of the T15 or any R/C helicopter is a must.

主旋翼鎖附，絕對不能鎖太緊，鎖緊後應用手折彎主旋翼，要有輕量阻阻感為佳，兩支主旋翼的鬆緊要一致，鬆度不平均或過緊會造成機體震動導致飛行時會不穩定，嚴重可能導致失控，請務必小心注意，並養成飛行前檢查與定期保養。

STEP 7-1 步驟 7-1

Hold the helicopter by hand to test rotation, and only fly if confirmed there is no excessive vibration from the helicopter. During test, hold the helicopter firmly, away from face/head, with protective eye-wear, and push the throttle up to 50%-60% under normal mode.

將直昇機抓在手上試運轉，確認直昇機無過大震動才可以飛行，試運轉時請將直昇機抓好，並遠離臉部，使用一般模式，油門推到 50%-60% 測試。



STEP 7-2 步驟 7-2

Should there be excessive vibrations, first check if there are any damaged or improperly installed parts (such as bent main and feathering shaft). If vibration persists after all parts are confirmed ok, the main blades can be balanced with the included blade balance decal (each sticker around 0.02g)

如果直昇機震動過大，請先確認機體各部位是正常無損壞或安裝不良(例：主、橫軸歪曲)，確認機體正常後，直昇機還是震動，可以使用隨機附送的主旋翼配重貼紙(單張約0.02g)，來為主旋翼進行配重平衡。

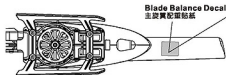

Weight stickers can be applied to the center of the backside. If vibration increases, move the sticker to the other blade. Once vibration is reduced, the sticker can be moved laterally along the blade to further minimize vibrations.

可以貼在旋翼背面的中心位置測試，如果震動加大，則換到另一支旋翼測試，震動減小後可移動貼紙位置讓震動量最小。

STEP8 步驟 8

Confirm all functions are normal, power cycle the system, and begin flight test after initialization. 確定所有功能正常，重新開機，完成開機程序後進入飛行測試。



Optional Equipment [HOT00010]
選購品 150 Blades Balancer
150主旋翼平衡器

PLEASE PRACTICE SIMULATION FLIGHT BEFORE REAL FLYING 飛行前請先熟練模擬飛行

A safe and effective practice method is to use the transmitter flying on the computer through simulator software sold on the market. Do a simulation flight until you familiarize your fingers with the movements of the rudders, and keep practicing until the fingers move naturally.

- Place the helicopter in a clear open field (Make sure the power OFF) and the tail of helicopter point to yourself.
- Practice to operate the throttle stick (as below illustration) and repeat practicing "Throttle high/low", "Aileron left / right", "Rudder left / right", and "Elevator up / down".
- The simulation flight practice is very important, please keep practicing until the fingers move naturally when you hear operation orders being call out.

在這沒解直昇飛機各動作的操控方式前，處於實體飛行，請先進行電腦模擬飛行的練習，一種最有效、最安全的練習方式，就是透過市面上販售的模擬軟體，以遙控器在電腦上模擬飛行，熟悉各種方向的操控，並不斷的練習，直到手能熟練的控制各各動作及方向。

- 將直昇機放在空曠的地方 (確保電源為關閉)，並將直昇機的機尾對準自己。
- 練習操作遙控器的各桿桿 (各動作的操作方式如下圖)，並反覆練習油门高/低、副翼左/右、升降前/後及方向前/左/右操作方式。
- 模擬飛行的練習相當重要，請重複練習直到不需思索，手就能自然隨著輸出的指令移動控制。



Mode 1	Mode 2	Illustration 圖示
		<p>Move Left 左移</p> <p>Rotate Left 左轉</p> <p>Move Right 右移</p> <p>Rotate Right 右轉</p>
		<p>Fly Forward 前進</p> <p>Forward Rotate 前轉</p> <p>Fly Backward 後退</p> <p>Backward Rotate 後轉</p>
		<p>Ascent 上升</p> <p>Descent 下降</p>
		<p>Turn Right 右轉</p> <p>Turn Left 左轉</p>

FLIGHT ADJUSTMENT AND NOTICE 飛行調整與注意



Ⓢ Do not attempt to grab or make contact with the helicopter while the main blades are in motion and keep your eyes away from the helicopter. During take-off, landing, and flight, be sure to keep the helicopter away from all obstacles. Operators must stand at least 5 meters away from the helicopter to avoid injury caused by loose parts due to improper assembly or any unforeseen dangers.

Ⓢ 嚴禁用手抓取運行中的直昇機，並禁止將直昇機對著眼睛，當主旋翼轉動後，或起飛/試飛時，務必遠離障礙物，站立位置必須距離5公尺以上，避免因人 為組裝不當造成零件脫落，而引發不可預期的財物及人員傷傷。



- Ⓢ Check if the screws are firmly tightened.
- Ⓢ Check if the transmitter and receivers are fully charged.
- Ⓢ 再次確認—螺絲是否鎖緊?
- Ⓢ 發射器和接收器電池電量是否足額。



If there are other radio control aircraft at the field, make sure to check their frequencies and tell them what frequency you are using. Frequency interference can cause your model, or other models to crash and increase the risk of danger. 假使飛行場有其他遙控飛機，請確認他們的頻率，並告知他們您正在使用的頻率，相同的頻率會造成干擾導致失控和大大地增加風險。

- When arriving at the flying field.
- 當抵達飛行場。



STARTING AND STOPPING THE MOTOR 啟動和停止馬達



First check to make sure no one else is operating on the same frequency. Then place the throttle stick at lowest position and turn on the transmitter.

首先確認附近沒有其他同頻率的應用，然後打開發射器將油門桿拉到最低點。

- Check the movement.
- 動作確認



ON! Step1
First turn on the transmitter.
先開啟發射器



ON! Step2
Connect to the helicopter power
接上直升機電源

Check if the throttle stick is set at the lowest position.
確認油門桿是在最低的位置。

- ① Are the rudders moving according to the controls?
- ② Follow the transmitter's instruction manual to do a range test.
- ③ 方向舵是否隨著控制方向移動?
- ④ 根據發射器說明書進行距離測試。



OFF! Step3
Reverse the above orders to turn off.
關閉電源時請依上述操作動作反執行。

FLIGHT ADJUSTMENT AND NOTICE FOR BEGINNERS 初學飛行調整與注意



- ① Make sure that no one or obstructions in the vicinity.
- ② You must first practice hovering for flying safety. This is a basic flight action. (Hovering means keeping the helicopter in mid air in a fixed position)
- ③ 確保附近地面沒有人和障碍物。
- ④ 為了飛行安全，您必須先練習停懸，這是飛行動作的基本（停懸：直升機靜在空中並保持固定位置）。



STEP 1 THROTTLE CONTROL PRACTICE 油門控制練習

When the helicopter begins to lift-off the ground, slowly reduce the throttle to bring the helicopter back down. Keep practicing this action until you control the throttle smoothly.

當直升機開始離地時，慢慢降低油門桿飛機降下。持續練習飛機從地面上升和下降直到您覺得油門控制很順。

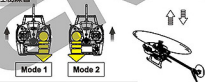

STEP 2 AILERON AND ELEVATOR CONTROL PRACTICE 副翼和升降控制練習

1. Raise the throttle stick slowly.
2. Move the helicopter in any direction back, forward, left and right, slowly move the aileron and elevator sticks in the opposite direction to fly back to its original position.

1. 慢慢升起油門桿。
2. 任意方向移動飛機時，請降低油門桿降落，然後移動自己的位置到直升機的正後方5公尺再繼續練習。



- ① If the nose of the helicopter moves, please lower the throttle stick and land the helicopter. Then move your position diagonally behind the helicopter 5M and continue practicing.
- ② If the helicopter flies too far away from you, please land the helicopter and move your position behind 5M and continue practicing.
- ③ 當直升機頭部偏移時，請降低油門桿降落，然後移動自己的位置到直升機的正後方5公尺再繼續練習。
- ④ 假如直升機飛離您太遠，請先降落直升機，並到直升機後5公尺再繼續練習。

STEP 3 RUDDER CONTROL PRACTICING 方向舵操作練習

1. Slowly raise the throttle stick.
2. Move the nose of the helicopter to right or left, and then slowly move the rudder stick in the opposite direction to fly back to its original position.

1. 慢慢升起油門桿。
2. 將直升機機頭移動至右或左，然後慢慢反向移動方向舵桿並將直升機飛回原本位置。

STEP 4

After you are familiar with all actions from STEP1 to 3, draw a circle on the ground and practice within the circle to increase your accuracy.

當您覺得 STEP1-3 動作熟悉了，在地上畫個圓並在這個圓的範圍內練習飛行，以增加您操作的準確度。

- ① 當您覺得 STEP1-3 動作熟悉了，在地上畫個圓並在這個圓的範圍內練習飛行，以增加您操作的準確度。
- ② 當您更加習慣操作動作，您可以畫更小的圓。



STEP 5 DIRECTION CHANGE AND HOVERING PRACTICE 改變直昇機方向和練習停懸

After you are familiar with STEP1 to 4, stand at side of the helicopter and continue practicing STEP1 to 4. Then repeat the STEP1 to 4 by standing in front of the helicopter.

當您覺得STEP1-4動作熟悉了，站在面對直昇機側邊並繼續練習STEP1-4。之後，站在直昇機機頭前方重複步驟練習。

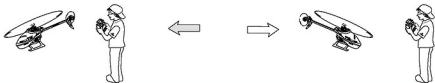

FLYBARLESS FLIGHT TEST PROCEDURE 飛行測試程序

飛行測試程序

ALIGN

ELEVATOR AND AILERON GAIN ADJUSTMENT 升降及副翼陀螺儀敏感度調整

Hover the helicopter and observe if there are any left / right or forward / backward fast oscillation. If oscillation exists, turn the cyclic gain value to reduce the gyro gain.

先將直昇機以停懸飛行，觀察直昇機左右及前後是否有不正常快速抖動現象。如果前後或左右有抖動，請將十字盤敏感度調低，以減少陀螺儀修正敏感度。

Forward/back oscillation · Left/right oscillation
前後晃動 / 左右晃動

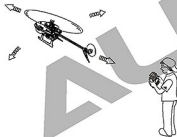

Reduce the Cyclic Gain Value
降低十字盤敏感度



FORWARD STRAIGHT LINE FLIGHT 前進直線軌道飛行

After hovering, proceed to fast forward flight. Should there be similar oscillation, please reduce gain. Should the helicopter pitch up or experience slow response during flight, increase gain. Repeat this process until ideal gain value is achieved. Pilot can also adjust the cyclic EXP setting for the preferred stability. After all adjustments are completed, the pilot can enjoy the stability of slow flight and the fast agility from flybarless system.

停懸完後可快速前進飛行，同樣的如果有不正常抖動時，請將敏感度調小，飛行時如果有機頭向上仰起或反應緩慢現象時，請將敏感度調大，重複測試將敏感度調整至理想值，使用者也可依據個人經驗調整陀螺EXP以增加停旋穩定性。完成所有調整後，就可享受T150GA所提供低速飛行的穩定性及高速時的靈活性。



Forward Flight
前進飛行



	Problem 狀況	Cause 原因	Solution 對策
Blade Tracking 變葉平衡	Tracking is Off 變葉	Bent feathering shaft or warped main blades. 橫軸彎曲或主旋翼變型	Replace the feathering shaft or main blades 更換橫軸或主旋翼
Hover 停懸	Head speed too low 主旋翼轉速偏低	Excessive pitch 主旋翼的 PITCH 偏高	Adjust pitch DFC to reduce pitch by 4 to 5 degrees. (Hovering head-speed should be around 5000RPM. 將 PITCH 調低約 + 4~5 度 (停懸的主旋翼轉速約 5000RPM)
		Hovering throttle curve is too low 停懸點油門曲線過低	Increase throttle curve at hovering point on transmitter (around 65%) 調高停懸點油門曲線 (約 65%)
	Head speed too high 主旋翼轉速偏高	Not enough pitch 主旋翼的 PITCH 偏低	Adjust pitch to increase pitch by 4 to 5 degrees. 將 PITCH 調高約 + 4~5 度
		Hovering throttle curve is too high 停懸點油門曲線過高	Decrease throttle curve at hovering point on transmitter (around 65%) 調低停懸點油門曲線 (約 65%)
Rudder Response 尾舵反應	Drifting of tail occurs during hovering, or delay of rudder response when centering rudder stick. 停懸時尾舵向某一邊偏移，或應動方向舵並以後部中立點時，尾翼產生反應，無法停懸在所控制位置上。	Over or under rudder compensation 尾舵補償過大或過小	Tail drafts counter-clockwise → increase rudder compensation 尾舵在逆時針方向偏移 → 加大尾舵補償 Tail drafts clockwise → decrease rudder compensation 尾舵在順時針方向偏移 → 減小尾舵補償
	Tail oscillates (hunting, or wags) at hover or full throttle 停懸或全油門時尾翼左右來回搖擺。	Rudder gyro gain too low 尾舵陀螺儀敏感度偏低	Increase rudder gyro gain 增加尾舵陀螺儀敏感度
		Rudder gyro gain too high 尾舵陀螺儀敏感度偏高	Reduce rudder gyro gain 降低尾舵陀螺儀敏感度
Oscillation during flight 飛行抖動	Helicopter oscillates forward/backward/left/right while performing cyclic maneuvers 升降或滾翻翼打動作時，機體前後左右抖動。 Helicopter front bobbles (nods) during forward flight. 直線飛行時，機頭點頭。	Swashplate gyro gain is slightly too high. 十字盤陀螺儀敏感度偏高，產生追蹤現象。	Reduce the Cyclic Gain Value 降低十字盤敏感度。
	Worn servo, or slack in control links 伺服機老化，控制結構有虛位。	Replace servo, ball link, or linkage balls. 更換伺服器、球桿頭、球頭。	
Drifting during flight 飛行偏移	Pitching up or aileron drift during forward flight 直線飛行機頭上揚或翼翼偏移	Swashplate gyro gain is slightly too low 十字盤陀螺儀敏感度偏低	Increase the Cyclic Gain Value 調高十字盤敏感度。
Control Response 動作反應	Slow Forward/Aft/Left/Right input response 前後左右飛行動作反應偏慢	Roll rate too low 滾轉速率偏低	Increase the Cyclic Roll Rate 調高滾速速率
	Sensitive Forward/Aft/Left/Right input response 前後左右飛行動作反應偏快	Roll rate too high 滾轉速率偏快	Reduce the Cyclic Roll Rate 調低滾速速率

If above solution does not resolve your issues, please check with experienced pilots or contact your Align dealer.

※在探究以上問題後，仍然無法改善情況時，應立即停止飛行並向有經驗的飛手諮詢或連絡您的經銷商。

Thank you for purchasing and supporting ALIGN products.

The ALIGN Team is dedicated to you by innovating and developing new RC Helicopters, Multicopters, and **Multi-Rotor Agricultural Drone**. We strive to provide a more diversified experience for our customers. Visit our website at www.align.com.tw for latest news, information, and updates about our extensive line of products for the RC enthusiasts.

Good Flying!

再次感謝您對亞拓系列商品的喜愛與支持，您的肯定是對我們最大的認同。

亞拓團隊秉持創新研發的精神，開發遙控直昇機／空拍任務無人機／植保無人機系列商品，提供給您體驗更多樣化的飛行樂趣。您可以透過下列連結，隨時瞭解亞拓的最新動態，以及各項訊息分享。

祝福您有一個愉快的飛行體驗。



ALIGN Flight Safety 亞拓飛行安全宣導
<http://www.align.com.tw/flysafe-en/>



ALIGN T-REX Helicopter 亞拓遙控直昇機
<http://www.align.com.tw/helicopter-en/>



ALIGN Multicopter 亞拓空拍/任務無人機
<http://www.align.com.tw/multicopter-en/>



ALIGN Multi-Rotor Agricultural Drone 亞拓植保無人機
<https://www.align.com.tw/index.php/demeter/>



ALIGN Website 亞拓官網
<http://www.align.com.tw>



ALIGN Shopping Cart 亞拓購物車
<http://shop.align.com.tw/index.php?language=en>



ALIGN Quick Finder 亞拓零件快速購
<http://shop.align.com.tw/partfinder.php?language=en>



ALIGN FaceBook
<https://www.facebook.com/Align-Corporation-194493419543/?ref=mf>



ALIGN Instagram
<https://instagram.com/aligncorporation/>



ALIGN YouTube
https://www.youtube.com/channel/UCaPj_K5DNo7HSmP1eytUvMQ



ALIGN Youku
<http://i.youku.com/u/UMTQ0NjEwNjczNg==>

ALIGN

ALIGN

Specifications & Equipment/規格配備:

Length/機身長:272mm

Height/機身高:85mm

Main Blade Length/主旋翼長:120mm

Main Rotor Diameter/主旋翼直徑:280mm

Tail Rotor Diameter/尾旋翼直徑:51mm

Flying Weight(without battery)/全配重(不含電池):Approx. 100g

